

ОБЪЕДИНЕННЫЙ  
ИНСТИТУТ  
ЯДЕРНЫХ  
ИССЛЕДОВАНИЙ

Дубна

E13-2007-98

V. Batusov<sup>1</sup>, J. Budagov<sup>1</sup>, J. Khubua<sup>1,\*</sup>, C. Lasseur<sup>2</sup>,  
M. Lyablin<sup>1</sup>, N. Russakovich<sup>1</sup>, A. Sissakian<sup>1</sup>, N. Topilin<sup>1</sup>

## ON A LASER BEAM FIDUCIAL LINE APPLICATION FOR METROLOGICAL PURPOSES

Submitted to the journal «Particles and Nuclei, Letters»

---

<sup>1</sup>JINR, Dubna, Russia

<sup>2</sup>CERN, Geneva, Switzerland

\*On leave from the Institute of High Energy Physics and Informatization, Tbilisi, Georgia

## INTRODUCTION

When metrology measurements execution has to be achieved, the question of so-called «fiducial points» (FP) positioned on the object to be measured and on the measurement stations forming a surrounding or a linear network has to be raised. One assumes that the relative locations of these FPs on object and stations have been well understood and foreseen so that the correct and comfortable executing of the measurements, network and object under study, can be achieved. As a rule, the «long-term» FPs and the measurement stations have a fixed contact with the rock monolith — pillar embedded in soil — that can be equipped with a suitable mechanic tooling for positioning precisely standard measurement units like theodolites, targets, prisms for measuring distances, etc. and in very accurate repetitive mode. As the experience shows, their relative long-term stability on about 100 m base is enough to perform, for a few years, measurements with a relative precision of  $\sim 10^{-6}$  [1–3]. In some cases it might be useful to foresee some pure mechanical or optical verification devices of centering structure (clinometers, short leveling from deep rods, etc.) in order to verify that no accidental bumps have occurred.

In the metrology measurement the «fiducial lines» (FL) are often used. They represent a set of FPs aligned along some line(s). For example, the measurements stations are sockets embedded in the tunnel floor and are used to install the LHC elements of which the accuracy is about 1 mm within the main geometrical frame all along the accelerator. The final relative locations of the adjacent machine elements —  $Q$  poles to  $Q$  poles, magnets to magnets — are cross-checked section by section with respect to the smoother line within the best accuracy (a few tenths of a millimeter) by using one unique stretched

wire attached to the FPs of the controlled elements [4–7]. High-accuracy measure and devices, redundancy whenever possible, cross-checks, errors tracing — specifically when controlling a unique straight section must be considered at all stages of a given process.

That is a so-called string metrology when the metrology task is to perform the measurements relative to some straight line [8–10]. The used device represents a mechanical setup where two FPs are connected by a tensed string, the real measures being horizontal or planar radial offsets measurements on intermediate FPs onto the string. The immovability and the datum of the straight line are guaranteed by the extreme FPs and the accurate measure must be guaranteed by the correct using of a very precise and calibrated ruler. The acceptable line length is determined by string saggita, caused by its weight, also the environment (absence of air draughts) and may reach  $\sim 100$  m. Knowing the metrology string space location (together with its saggita) relative to FPs, one may use the string for radial metrology measurements, the process being not adapted to provide accurate elevation data.

One of the main advantages of the FLs is the possibility to have an on-line control of the location of the object under measurement, but any control or monitoring in elevation will imply another system.

The measurement system efficiency is noticeably increased if instead of metrology string one uses the one-mode laser beam.

Below we consider different options of a laser collimated beam over a long distance and of such a system application for extended objects (or set of objects like accelerator modules).

# 1. THE LASER FIDUCIAL LINES (LFL)

A geometrical reference network represents a set of complex and various metrology devices used for the determination of  $XYZ$  coordinates in a given system — either the reference network or the object network or any other spatial one. The coordinate system determination in connection with a network in the framework of «fiducial points» and «measurement station» concept is considered in the Attachment.

By analogy with a metrology string we connect two fiducial points FP1 and FP2 of a network by the laser ray. For this purpose we position the laser source at FP1 and direct the beam to the center of the quadrant photoreceiver QSFP2 (QS: quadrant sensor) located at the second fiducial point FP2 (Fig. 1).

As the laser beam is a one-mode system and since the distribution of radiation power density across a ray is symmetric, the quadrant cell, if having an equal signal from the opposite photosensors, will determine as a beam center the point with a maximal radiation density. The set of points with the maximal radiation density composes — by definition — a laser beam axis.

FP1 and FP2 are equipped with accurate mechanical devices centering the instrumentation in either a precise

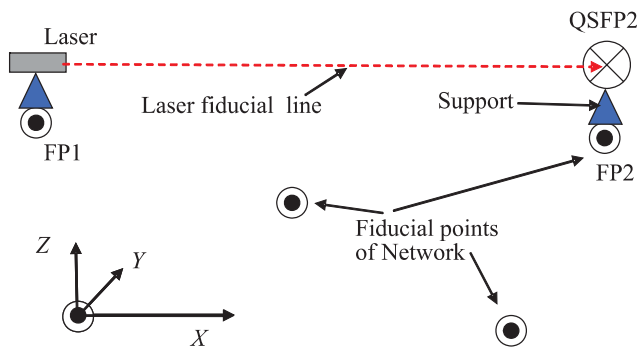

Fig. 1. The network with a laser line

hole or a specific socket that assures the reproducibility of the location of the laser and the measures on the sensor which can be mounted on a precise target holder (Fig. 2).

The precise determination of the radial and transverse coordinates of any given point  $P$  of an object  $W$  (Fig. 3) from the laser fiducial line FP1–FP2 requires also that the sensor QSP in  $P$  be centered in such a precise hole or a specific socket. The  $P$  coordinates can be determined from the readings on the sensor QSP; however, no information along the beam can be determined in such a linear configuration.

Any change of the current location in  $P$  due to deformation or during a precise positioning operation is recorded permanently and periodically since any slight offsets in radial and transverse directions induce unbalanced signals on the sensor QSP.

Auxiliary and additional centering devices can be arranged in various ways, either for the laser beam or for the sensor locations by using optical cubes so that the on-line control is arranged as a continuous monitoring and indestructible fiducial line, comprising laser and optical cubes.

In this case, the optical cube redirects part of a laser beam power to the quadrant photoreceiver QSP, leaving the dominant part free for the control of the fiducial line. The optical cube position is determined by the equality of signals on the QSFP2 at the second fiducial point FP2. In this scheme one can execute the on-line control of a few points under measurement on the object  $W$  simultaneously. Another arrangement could be that the quadrant sensor is part of the object ( $QSP_{obj}$  in Fig. 4) and the optical cube redirects the laser beam to this sensor.

In both cases, sensors and optical cubes have to be centered in precise mechanical reference holes or sockets. In either case, the laser fiducial line is free of disadvantages compared to the metrology using stretched

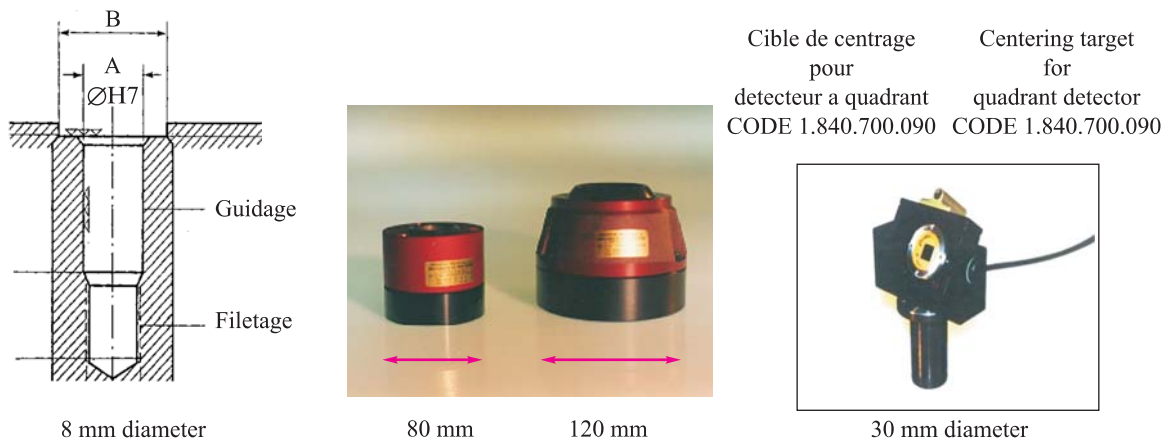

Fig. 2. Precise reference hole, specific sockets, quadrant-sensor target (type CERN) (CERN TS-SU-EM library and <http://edms.cern.ch/nav/CERN-0000003489>)

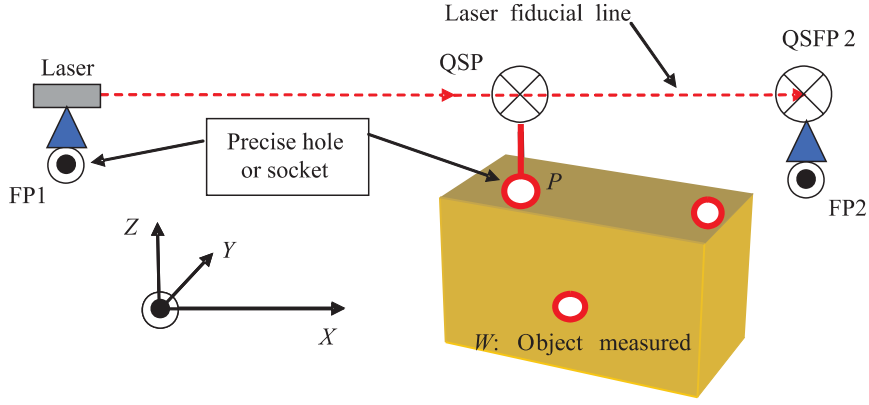

Fig. 3. The  $P$ -point coordinates measurements by use of a laser fiducial line

strings such as sagitta non well known, own frequency oscillations, residual twist, risks of mechanical damaging, measures biased because of global or local turbulences, etc. Laser fiducial line process and various adaptations would allow high reliability measurements when controlling or positioning an object.

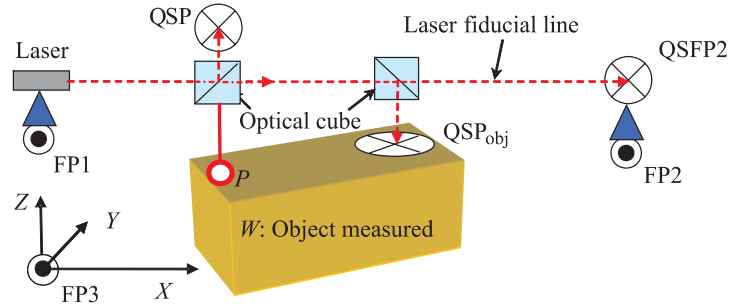

Fig. 4. The principal scheme of an on-line control of the  $W$  object under study with an «indestructible» fiducial line

## 2. THE LENGTH OF A LASER FIDUCIAL LINE

When organizing a laser fiducial line, one often uses the one-mode laser ray [11, 12]. The power density distribution across a beam is

$$P = P_0 \exp\left(-\frac{d^2}{d_0^2}\right), \quad (1)$$

where  $P_0$  is a maximal radiation power density,  $d_0$  is the diameter of a one-mode laser ray;  $d$  is the distance from the ray axis (Fig. 5).

The one-mode laser diameter  $d_0$  is given by (1) and condition  $P = P_0 1/e$ . Exit aperture laser resonator diffraction leads to the divergence of a ray. It increases the ray diameter proportionally to the distance the beam passed and it becomes a main limiting factor when organizing long laser fiducial lines.

The angular divergence of a one-mode laser beam is [13]

$$\gamma = 1.22 \frac{\lambda}{D} \quad (2)$$

with  $\lambda$  as laser radiation wave length and  $D_0$  as output diameter of a laser ray. For the  $\lambda = 0.4 \mu\text{m}$  and  $D = 1 \text{ mm}$  we obtain  $\gamma = 4.9 \cdot 10^{-4} \text{ rad}$ .

Let us define the laser ray length  $L_{\text{laser}}$  on condition that it diverges to the quadrant photoreceiver diameter  $D_{\text{QS}}$  with the condition:  $L_{\text{laser}} \gg D$  and  $D \ll D_{\text{QS}}$ . We obtain  $\gamma \approx D_{\text{QS}}/L_{\text{laser}}$ . For  $D_{\text{QS}} = 15 \text{ mm}$  we get laser length  $L_{\text{laser}} \approx 30 \text{ m}$ .

For the one-mode laser the passed maximal length  $L_{\text{max}}$  with no increase of ray diameter  $D$  can be achieved in the optical scheme [13] shown in Fig. 6.

Here by the telescope the ray is formatted to have the  $D$  diameter, then is focused onto  $D_0$  and again expanded to  $D$  for the distance  $L$ . The collimation length  $L$  is

$$L = \frac{2\pi}{\lambda} D_0^2 \quad (3)$$

with  $D_0 = \frac{1}{\sqrt{2}} D$  as a waist diameter.

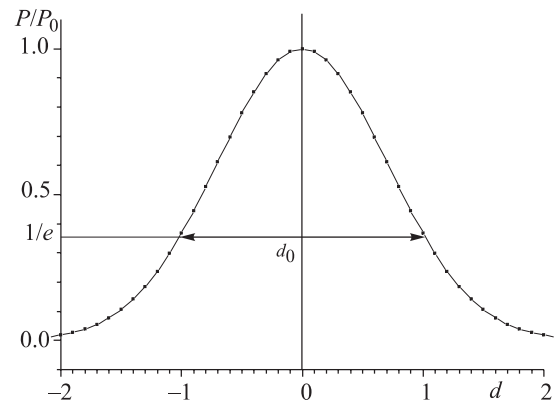

Fig. 5. Power density distribution in the one-mode laser ray cross section

As the laser ray diameter along its propagation path cannot exceed the quadrant photoreceiver diameter  $D_{QS}$ , the maximal length  $L_{\max}$  of a laser fiducial line is

$$L_{\max} = \frac{\pi}{\lambda} D_{QS}^2. \quad (4)$$

With a blue  $\lambda = 0.4 \mu\text{m}$  one-mode laser ray and the quadrant photoreceiver diameter  $D_{QS} = 15 \text{ mm}$  [14], one gets the propagation length  $L_{\max} \approx 170 \text{ m}$ .

### 3. LASER FIDUCIAL LINES LONG-TERM ANGULAR STABILITY

One of the major problems arising when organizing a laser fiducial line (coordinate axes) is a necessity to support a long-term angular stability of a laser source. Indeed, the lasers represent a light source with a large heat release and, after being switched on, they deform the optical elements of a resonator, the fixing devices, etc., which leads finally to the long-term uncontrolled angular drift of a laser beam from its original direction. In the best laser samples the angular long-term (daily) angular drift reaches  $\sim 10^{-6} \text{ rad}$  [15–17].

To achieve a long-term angular stability, one proposes to use the optical fiber connection (Fig. 7).

The laser beam is being entered into a one-mode optic fiber [18], and an exit end of the fiber is fixed in a temperature-controlled unit positioned at a fiducial point. The laser radiation almost entirely passes through the fiber, not heating it. So one «excludes» the temperature deformations of a laser source and, accordingly, its long-term angular stability is getting increased.

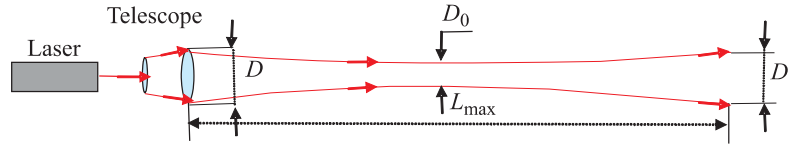

Fig. 6. An optical scheme of the extended one-mode laser ray collimation

After the laser beam exit off an optical fiber, this beam is forming, with the use of specially chosen lenses, a fiducial line following the above-described scheme.

It seems that the very main external noise factor, which limits the reduction of laser beam angular oscillations, is the Earth seismic oscillations. The angular amplitude of these oscillations was estimated to be  $\sim 10^{-8} \text{ rad}$  [19, 20], which leads — at a distance of 2 km — to  $20 \mu\text{m}$  uncertainty in the beam localization precision.

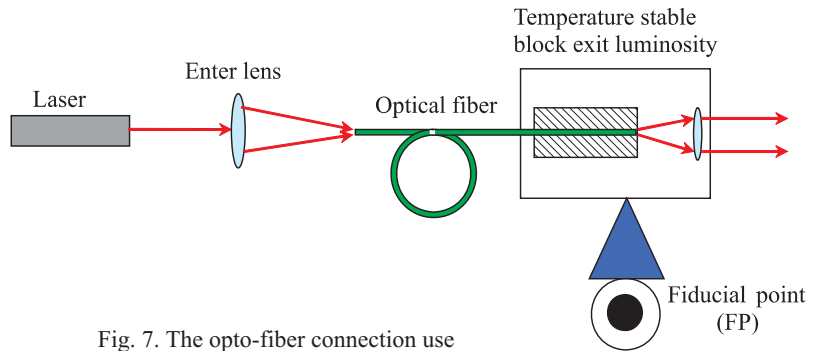
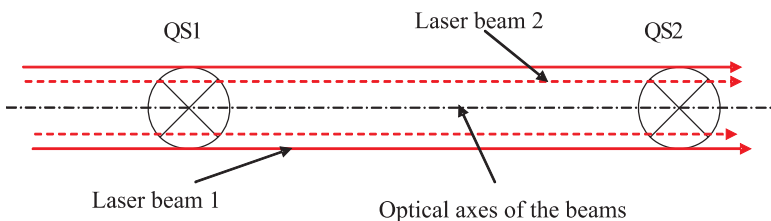

Fig. 7. The opto-fiber connection use

### 4. ORGANIZATION AND PRINCIPAL SCHEME OF THE LONG FIDUCIAL LINES

For the majority of metrology tasks it seems to be sufficient to use  $\sim 2 \text{ km}$  long fiducial lines. But for the adjustment and on-line control of an especially extended setup, for example, array of accelerator sections of a linear collider, one needs to organize the fiducial line up to  $\sim 15\text{--}20 \text{ km}$  in length. In such a case, one proposes an «extended collimation» technology. Its essential feature



is an overlapping of two laser lines in such a way that their propagation axes coincide. Figure 8 shows a possible option of such an overlapping.

The overlapping is made with the use of two widely separated quadrant photoreceivers QS1 and QS2. The photoreceivers are semitransparent for the laser rays passing through them. If we overlap the laser rays axes with the quadrant photoreceivers, then we finally obtain the rays propagation along a common axis.

Fig. 8. Laser lines overlapping with the use of semi-transparent quadrant photoreceiver

To organize an «extended collimation», one performs the rays overlapping procedure on the second half of the length  $L$  of a primary beam collimation (Fig. 9). The second laser ray with an optical cube use is entered into the collimating line at the waist point of the first beam at an  $L/2$  distance from a source. In this situation the second ray, once overlapped with the first one, will move further extending the common collimated beam with *no* increase of its diameter. In other words, at an  $L$  distance from the Laser 1 source the beam diameter for Laser 2 ray will be  $d_0$  and consequently at a  $1.5L$  distance will be equal to  $D$ .

So to summarize, one can say that, with two rays from two sources overlapped, it is possible to extend the collimated line at a distance of  $L/2$ . The primary laser ray in the extended region will continue its existence, but because of its divergence the degree of this ray «participation» in the common collimated beam gradually falls down.

If the primary fiducial line (with Laser 1 as a source) contains in its basement the fiducial points «1», FP1, and «2», FP2, then on the extended collimated line with the use of the QS3 there can be organized a new fiducial point «3», FP3 (with Laser 2 as a source). Because of the laser axes coincidence this new point is located on the

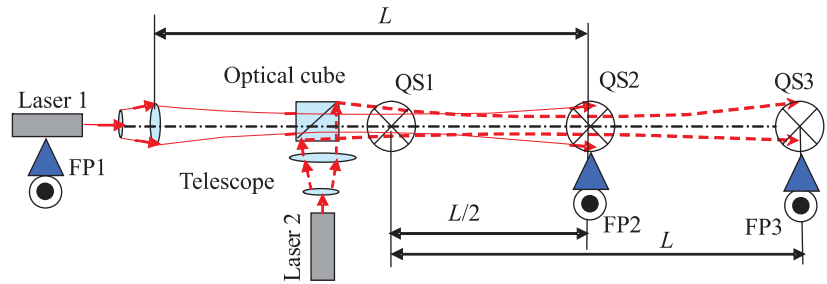

Fig. 9. The scheme of an «extended collimation» of a laser beam

straight line connecting the first and the second fiducial points. The condition that all the three fiducial points belong to the same straight line allows one to determine the coordinates of the new point «3». By repeating such a procedure, but having taken as a base the part of the fiducial line between the points «2» and «3», one can extend the beam and organize a new fiducial point. So, finally the extended laser fiducial line will have a primary laser source and  $N$  additional ones.

As can be seen, the laser rays due to consequent overlapping between themselves *extend* (without increase in primary laser beam diameter  $D$ ) the fiducial line for an  $LN/2$  distance. This method is quite economic when using a small number of sources in a laser fiducial line.

## 5. PRACTICAL METHODS OF ORGANIZING A LONG LASER FIDUCIAL LINE

**5.1. The Scheme with an Optical Cube.** The use of a semitransparent photoreceiver for creating a long laser line is in itself technically rather uneasy.

Therefore, for our purposes it will be more convenient to include in our scheme a new combined element — the optical cube (Fig. 10). It combines two functions:

- a) an additional laser ray input in an extended laser fiducial line and
- b) overlapping of laser rays.

**5.2. The Scheme with Parallel-Sided Plates.** The above task can be handled by an array of two parallel-sided plates. In this scheme, one plate has semitransparent cover, and the other plate serves for a compensation of a laser ray shift (Fig. 11) [21]. The use of such a scheme helps to avoid an appearance of the ray reflection in the direction to a laser; these reflections cause the instabilities in laser source.

The correctness of optical element adjustment is determined with the use of a photoreceiver located at the next (after optical elements) fiducial point.

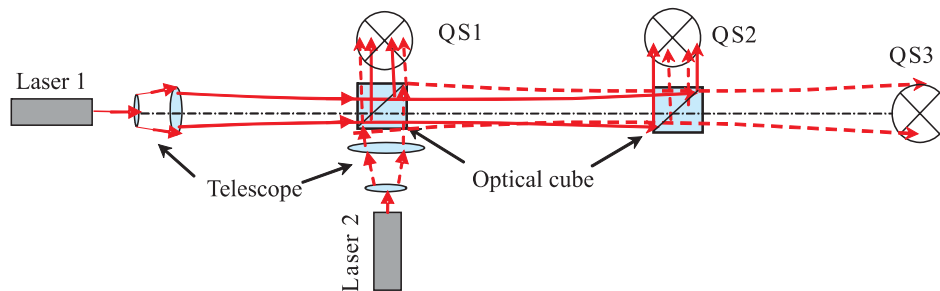

Fig. 10. The use of an optical cube for laser fiducial line formation



**5.3. The Scheme with an Optical Fiber.** When creating a long laser fiducial line one needs to have  $N + 1$  laser sources. This complexity is removed by using only one laser with branching optical fibers to organize the exit system (Fig. 12).

In this case, one uses the laser wave length  $\lambda = 1.5 \mu\text{m}$ , which corresponds to a region of maximal transparency of an optical fiber [22].

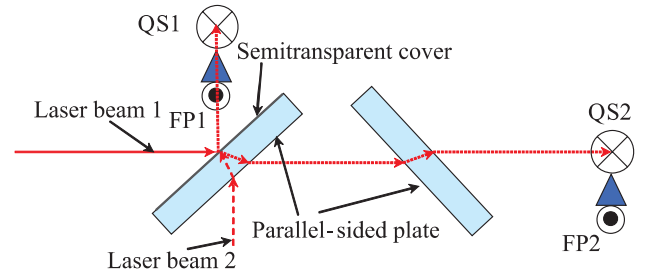

Fig. 11. The use of an array of two parallel-sided plates to combine laser beam

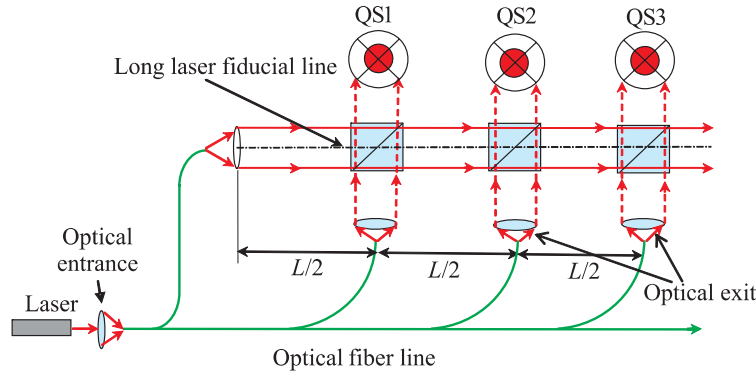

Fig. 12. The use of an optical fiber to bring the laser radiation to the «extended collimation» laser line

## 6. THE USE OF LASER FIDUCIAL LINES TO CREATE A REMOVED FIDUCIAL POINT

Suppose we have some array of fiducial points (Network) which allows one to measure the different objects geometry in a limited space within the Network.

There exists a necessity to connect this Network with another analogous fiducial points array (second Network) located at a large distance from the first one. To solve this task, one may use the laser fiducial line. Figure 13 shows a practical scheme to organize the connection of the two networks with the use of laser fiducial line.

Between the fiducial points  $A$  and  $B$  in Network 1 ( $A, B, C$ ) one organizes the laser fiducial line in the direction to Network 2 ( $A', B', C'$ ). In the region of Network 2, one creates a fiducial point  $O$  located on the laser beam axis. This point coordinates are determined following the

standard procedure to include an additional fiducial point in Network.

A necessary additional step to connect the two Networks is the determination of distances between the fiducial points  $B$  and  $O$  on laser fiducial line. This distance measurement is done following the standard laser location technology [23]. Then with the known distances between the fiducial points, one can determine their coordinates both in the first and in the second Networks, which means establishing the connection between two systems.

When long laser fiducial lines are used, the measurement of distances is performed between the fiducial points which are created in additional laser rays entrance points. Finally, one calculates the summary distance between the fiducial points of a laser fiducial line (Fig. 1).

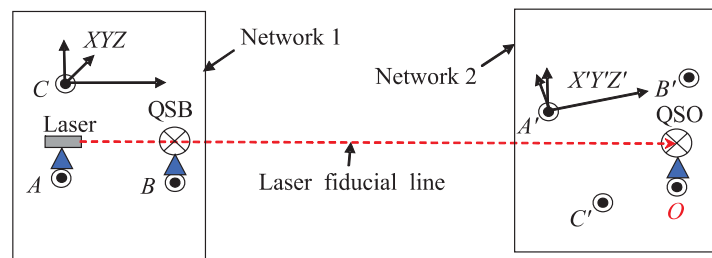

Fig. 13. Organizing of two Networks coordinates connection

## 7. THE NOISES OF A LASER FIDUCIAL LINE

The factor limiting the application of a laser ray as a fiducial line is the instability of its axis space location during ray propagation. This instability is caused by different reasons:

1. The laser ray interaction with surrounding turbulent air leads to perturbation in laser power distribution across a beam. Being registered by the photoreceiver, this factor is interpreted as a noise bias of the laser ray axis. An additional component of this noise is laser scattering by the air weighted dust.
2. When irradiating, the laser source and the surrounding supports of a fixing element is heated very noticeably. It leads to the appearance of a long-term laser beam angular drift from its original direction.
3. There exist both the long-term (a few hours) and short-term (1–30 s) instability of the laser source basement, having the seismic origin. These are in particular Moon influence effects, Earth seisms, wind load on the Earth surface, etc.
4. When laser radiation is registered by the photoreceiver there arises so-called shot noise. This kind of noise appears due to quantum uncertainties during laser irradiation and due to a fluctuation when registering by photosensor and both are irremovable. In the works [24, 25] a value of laser beam displacement on the photoreceiving unit was determined (based on the amplitude of the shot noise).

We have conducted an experiment [26] schematically shown in Fig. 14. In this work we have studied the noise oscillations of a laser beam at a distance  $L = 9$  m for

a 5 min observation period. The results obtained show that the dominant factor affecting the laser beam rectilinear proliferation is air medium turbulence.

However, during laser ray propagation inside a tube we have discovered a significant (up to a factor of 10) suppression of this kind of noise: the achieved spread of laser ray noise oscillation over 9 m distance is characterized by the r.m.s. value of  $\sigma = 2 \mu\text{m}$ .

The discovered  $\sim 10$ -fold decrease of  $\sigma$  value seems to be highly essential for deeper understanding of a technical means and methods necessary to achieve a high-precision large-distance laser metrology.

Now we plan to carry out a more detailed further study of noise limitations on a laser ray rectilinearity propagation over a distance up to 100 m with the use of a dust free laminated air flux inside a tube (Fig. 15).

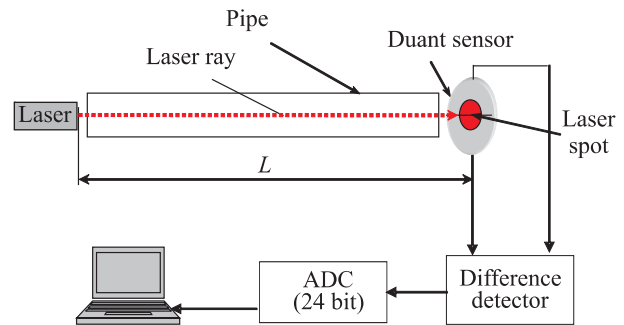

Fig. 14. Experimental setup

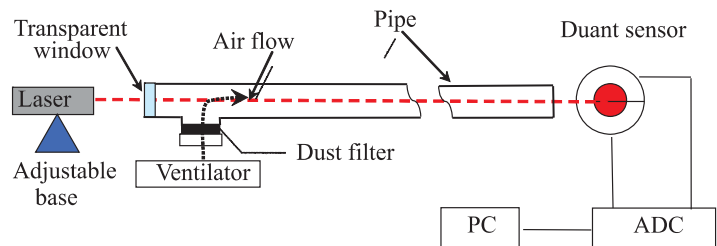

Fig. 15. The planned experiment scheme to determine the noise oscillations of a laser beam passing through dust free laminated air flux in tube

## CONCLUSIONS

The proposal to use the one-mode laser ray opens a rather promising new direction — a precision large-distance laser metrology. Its advantages seem to be the following ones:

1. The use of laser beam changes radically the measurement methodology: one uses not a visual optical line in the theodolite tube and level, but a laser ray. Such a replacement excludes a possibility of an operator's mistakes; the measurement process itself is controlled by the device independent of a «human factor»; the «centre of gravity» of a measurement is

transferred onto a point under observation, which is a very significant change of measurement method concept. The laser metrology promises a new possibility of principal significance when controlling an object in closed (say radioactive) or in inaccessible territory, or when object under control is not of an easy access in itself (big, high, etc.).

2. Particularly efficient is the use of a laser ray when forming very long fiducial lines. Practically it starts a new class of fiducial lines of large length which has no analogue in the measurement practice.



3. The methodology based on large-length laser fiducial lines permits on-line control of the position of objects under measurement. It gives the possibility to realize a long-term auto-adjustment of the relative position of many-object array like linear accelerators sections.
4. The use of laser fiducial lines allows one to create a removed fiducial point which has coordinate connection with the basic Network(s), or to connect two or more independent far separated Networks from each other into one common coordinate system.

## ATTACHMENT

### REFERENCE SYSTEM, SURVEY PROCEDURE AND EQUIPMENT APPLIED TO THREE-DIMENSIONAL INDUSTRIAL METROLOGY

*C. Lasseur*

#### I. REFERENCE SYSTEM

The basic of metrology is the definition of a unique reference system — the datum — in which the measured spatial coordinates of any fiducial point, measurement station, object point plus interior or exterior control point can be expressed.

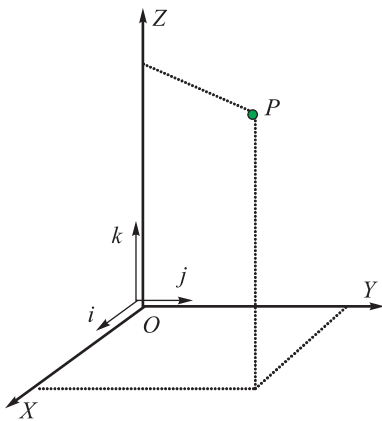

Fig. I. The affine frame of the ideal reference system

An ideal reference system (Fig. I) must be defined in an Euclidean affine space of three dimensions where the origin is a point in space and the three vectors are orthogonal with the same length — unit vectors co-linear to the base (orientation) and unit of length (scale, same norm for the three vectors).

A conventional reference system is a set of conventions, algorithms, constants used to determine object positions in an ideal reference system and must allow any spatial matrix transformation in such a way that the measured coordinates can be given in a more appropriate system, proper object system or a more significant one. The transformation parameters — translation and orientations vectors, all with the correct signs, plus scale factor — must be cared so that there are no risks of geometrical inconsistencies or wrong final results (mirror effects).

A conventional reference frame (Fig. II) is a set of physical objects with their coordinates and is the materialization of an ideal reference system. The coordinate system can be 3D Cartesian ( $XYZ$ ), spherical ( $R, \theta, \lambda$ ), cylindrical ( $l, \lambda, Z$ ), ellipsoidal ( $\lambda, \varphi, h$ ), 2D geographic ( $\lambda, \varphi$ ) or 1D height system ( $h$ ) [27].

It can be defined with the very minimum geometrical parameters without constraints — free system — and chosen arbitrarily by the user (system fixing). The sys-

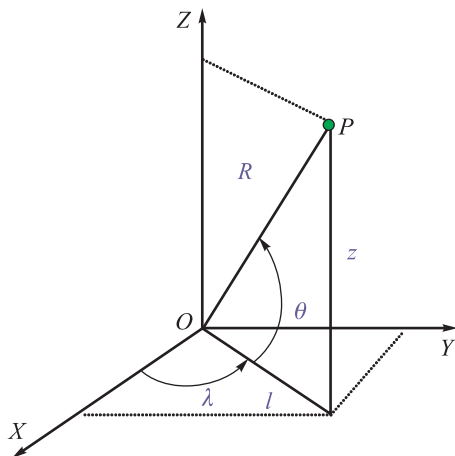

	$l \cos \lambda$	$R \cos \theta \cos \lambda$
$OP$	$l \sin \lambda$	$OP \quad R \cos \theta \sin \lambda$
$Z$	$Z$	$R \sin \theta$
Cylindrical		Spherical

Fig. II. 3D Cartesian, spherical and cylindrical coordinate systems



X axis: positive towards FP2, second fiducial point in such a way that  $Y_{FP2} = 0.0$   
 Y axis: perpendicular to X in such a way that the system is right-hand oriented  
 Z axis: perpendicular to the plane XY and positive to the top  
 Origin: FP1 defined as a fiducial point,  $X_{FP1} = 0.0, Y_{FP1} = 0.0, Z_{FP1} = 0.0$

Fig. III. A conventional reference frame of a local XYZ coordinate system

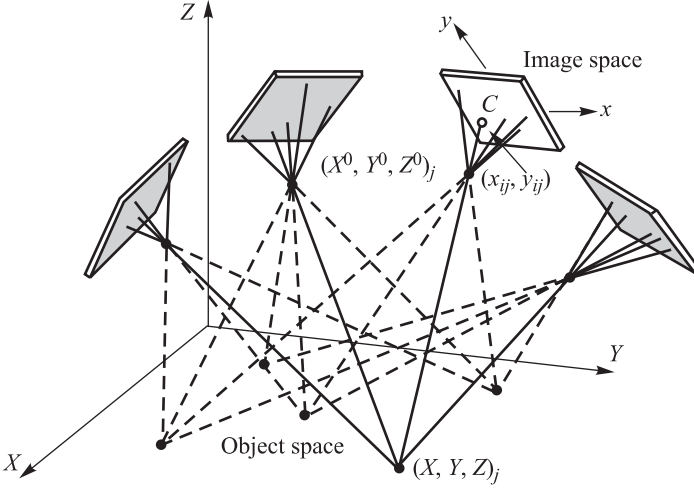

$$\begin{bmatrix} x_{ij} - x_H - dx \\ y_{ij} - y_H - dy \end{bmatrix} = \frac{-c}{Z_{ij}^*} \begin{bmatrix} X_{ij}^* \\ Y_{ij}^* \end{bmatrix}$$

$$\begin{bmatrix} X_{ij}^* \\ Y_{ij}^* \\ Z_{ij}^* \end{bmatrix} = D(\omega_j, \varphi_j, \kappa_j) \begin{bmatrix} X_i - X_j^0 \\ Y_i - Y_j^0 \\ Z_i - Z_j^0 \end{bmatrix}$$

Fig. IV. Mathematical definition of a photogrammetry coordinate system

Camera interior orientation (image space):  $c$  focal length,  $x_H, y_H$  principal point coordinates,  $dx, dy$  systematic image errors (distortion parameters)

Camera exterior orientation (object space):  $X_j^0, Y_j^0, Z_j^0$  perspective center coordinates, axis, tilt, swing angles  $(\theta_j, \varphi_j, \kappa_j)$

$x_{ij}, y_{ij}$ : image point coordinates (image space),  $X_{ij}^*, Y_{ij}^*, Z_{ij}^*$ : point coordinates (auxiliary system parallel to the image space),  $X_i, Y_i, Z_i$ : point coordinates (object space),  $D(\omega_j, \varphi_j, \kappa_j)$ : rotation matrix from the object space into a position parallel to the auxiliary system

tem can be linked to measurement stations (Fig. III) or any other points.

It cannot be considered as a main rule that the axis Z is in the direction of the gravity, the two other axes being located in the plane perpendicular to the Z axis. It might be far easier to define a proper object coordinate system, not related to the gravity, but more significant to the own object geometry.

In photogrammetry or laser tracker techniques, the instrumentation (portable digital cameras and interferometer coupled to encoding tracking angles devices) is not referred to any outside reference axis or plane directly, the parameters fixing the reference system being attached to the instrument itself (inner orientation of the digital chip with respect to the principal centre and the optical axis). Therefore, auxiliary parameters have to be determined such as the vectors of the translation-orientation matrix to transform an inner system (image space) into an exterior system (object space) (see Fig. IV).

When the project has to be installed on a very large scale on the earth surface, exact form, dimensions, rotation and gravity field of the earth must be taken into account. A geodetic activity has to be activated for the de-

termination of point/object positions over the earth surface and there is a need for a terrestrial reference system and an adapted coordinate system.

The earth has a highly irregular and constantly changing surface. Through a long history, the «figure of the earth» was refined from flat-earth models to spherical models of sufficient accuracy to allow global exploration, navigation and mapping. True geodetic datums were employed only after the late 1700s when measurements showed that the earth was ellipsoidal in shape. Topographic and sea-level models attempt to model the physical variations of the surface, while gravity models and geoids are used to represent local variations in gravity that change the local definition of a level surface (see Fig. V) [28, 29].

The  $\varepsilon$  angle between the directions of the ellipsoidal normal and of the plumb line at a given point is called the deflection of the vertical or astrogeodetic deflections. The vertical separation between the geoid and a particular reference ellipsoid is called geoid undulation  $N$ .

Gravity models attempt to describe in detail the variations in the gravity field and the importance is related to the leveling. Plane and geodetic surveying uses the idea

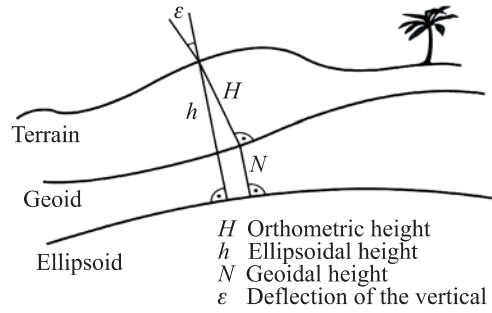
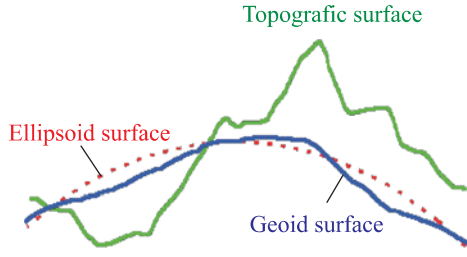

Fig. V. Earth surfaces, geoid, geoidal height and deflection of the vertical

of a plane perpendicular to the gravity surface of the earth, the direction perpendicular to a plumb bob pointing toward the center of mass of the earth. Local variations in gravity, caused by variations in the earth's core and surface materials, cause this gravity surface to be irregular. Geoid surface models attempt to represent the surface of the entire earth over both land and ocean as though the surface resulted from gravity alone.

Ellipsoid earth surface models are required for accurate range and bearing calculations over long distances. It closely approximates the physical shape of the earth, and it is smooth and convenient for mathematical operations: it is used as reference surface for horizontal coordinates in geodetic networks and is defined with an equatorial radius and a polar radius (see Fig. VI).

The best of these models can represent the shape of the earth over the smoothed, averaged sea-surface to within about one-hundred meters. It is less suitable as a

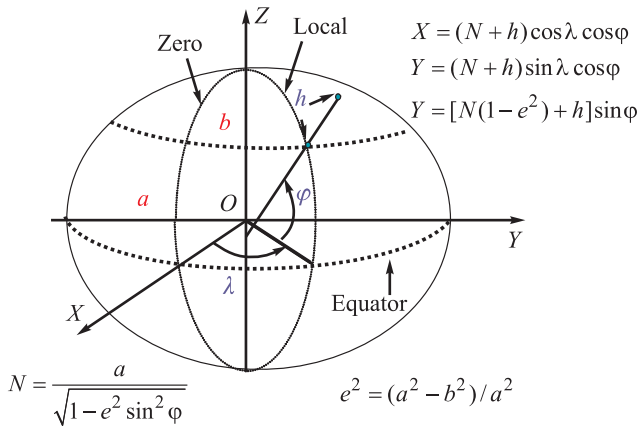

Fig. VI. Ellipsoidal and Cartesian coordinates

reference surface for vertical coordinates (heights): instead the *geoid* is used and is defined as that level surface of the gravity field which best fits the mean sea level and it is extended inside the solid body of the earth.

A local ellipsoid can be defined so that the distributions of the known deflections of the vertical fulfil some minimum conditions in the adjustment (Fig. VII). Therefore, a geodetic datum describes the relationship between the particular local ellipsoid and a global geodetic reference system, and three translation components, three rotations and one scale factor are needed.

Within the same approach, a global reference orbit of an accelerator can be uniquely defined by the sequence of physical elements. The local reference system  $(x, y, s)$  may thus be referred to a global Cartesian coordinate system  $(X, Y, Z)$ . The positions between the beam elements being numbered  $0, \dots, i, \dots, n$ , the local reference system  $(x_i, y_i, s_i)$  at position  $i$ , i.e., the displacement and direction of the reference orbit with respect to the system  $(X, Y, Z)$ , are defined by three displacements  $(X_i, Y_i, Z_i)$  and three angles  $(\theta_i, \phi_i, \varphi_i)$  [30].

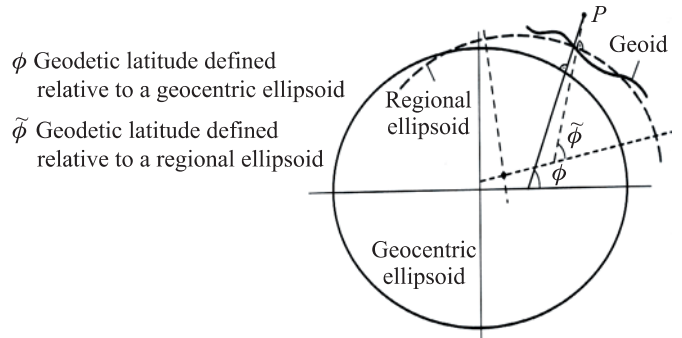

Fig. VII. Global and local ellipsoid and datums

## II. SURVEY PROCEDURE AND EQUIPMENT

An important condition for the high-precision measurements is the long-term coordinate system stability. If the gravity vector direction has a long-term direction stability  $\sim 10^{-8}$  rad [19], the other directions stability in the coordinate system is determined by the stability of fidu-

cial points FP1 and FP2 «creating» the coordinate system.

The dimensional and positioning quality of any object depends on the determination and the densification of its typical geometrical elements which would give its

definition and identification, namely, lines, axes, planes, surfaces, reference points, fiducial marks, cloud of points [31]. Therefore, the point is the key element of any representation and the knowledge of the positioning uncertainty will depend on the definition of the point, its nature and quality (cross mark, pin, circle, target, hole, wire, ...), also on its spatial relative accuracy and its link to the surrounding points. A domain of positioning uncertainty is worthy of better consideration than a given numerical value since any error budgets come from a stochastic analysis, 1 r.m.s sigma being defined at 66% and the tolerance, if as twice the r.m.s, being defined at 95%.

The fiducial known coordinates point is the centre of a target enclosed inside of a spherical holder positioned on the socket of the measurement station, all mounted on a bracket (see Fig VIII).

The kinds of targets are adapted always to the different types of mea-

asures, such as Taylor–Hobson ball for precise angles measurements between reference stations, smaller balls and well-contrasted sight buttons for industrial objects, corner cubes for precise distance measurements, quadrant cell sensors, diode target, etc. According to the utilization, any target can be adapted mechanically to its holder and socket or reference hole (see Fig. IX).

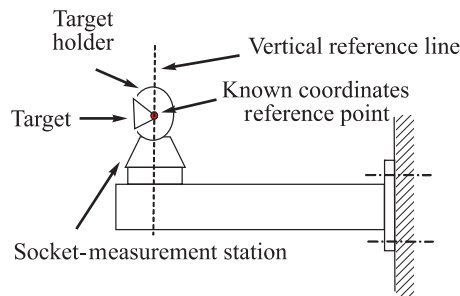

Fig. VIII. The fiducial reference point and the measurement station and various types of brackets (CERN TS-SU-EM library)



CIBLE OPTIQUE ORIENTABLE,  
ETALON DE LABORATOIRE  
A SPHERE LUMINEUSE  
INTEGREE  
Code 1 840 700 100

ORIENTATE CENTERING  
TARGET LABOR GAUGE  
WITH LUMINOUS SPHERE  
INTEGRATE  
Code 1 840 700 100



Fig. IX. Various types of targets on socket or specific adapter (CERN TS-SU-EM library)





Fig. X. Various types of measurement stations (CERN TS-SU-EM library)

The repeatability and reproducibility must be ensured so that precise instrumentation centering and high accuracy of the relation target / known coordinates point are assumed, specifically when various types of measures have to be mixed and linked to each other. That also implies a well-controlled stability of the instrumentation, targets included, and of the supporting structure (brackets, sockets, etc.). Relevant processes must be developed to verify these conditions before any use in the field (calibrations, use in symmetrical positions, etc.).

The measurement stations are also adapted to the different kinds of measures, working conditions and environment, specifically when a network has to be developed along or around the project (exterior geodesy, accelerator and large physics experiment networks). Specific high-accuracy mechanical systems like repro-

ducible column, foldable or isostatic plug-in brackets or tripods must meet various operating conditions (see Fig. X). Again relevant processes must be developed to verify the quality conditions before any use in the field.

Once the quality of fabrication has been cross-checked and the process of using the adapted instrumentation has been defined and tested by the main users, one can consider that the positioning of the measurement tools and the fiducial mark(s) on the measurement station and the reference hole, are known precisely relative to the given tool rotation axis and one can operate in any spatial direction.

Based on the socket system, specific tooling can ease measures — extensions, radial or elevation ruler, adapted centering systems — and also permit additional types of measures like measuring either manually or electronical-

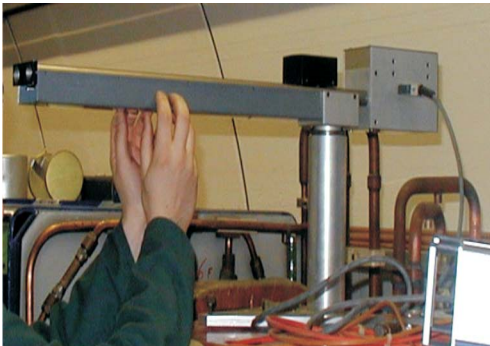
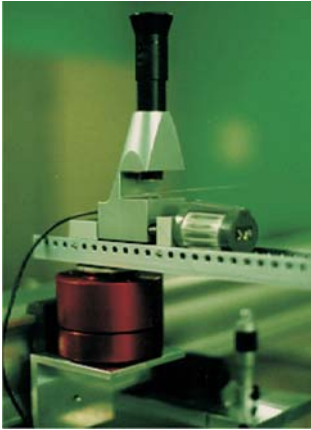

Fig. XI. Specific socket adaptations for various types of measures (CERN TS-SU-EM library)

ly the direct offsets at given points from a line materialized by a stretched wire or a laser beam or using a specific electro-optics angle monitor camera [32]. These adaptations are very relevant for on-line follow-up, specific and independent local inspection and cross-check conventional survey (see Fig. XI).

Standard socket can also be mounted on high-accuracy workshop measuring bench for metrological works in laboratory conditions or in portable adapted gauge

when installing permanent sockets is not possible (see Fig. XII).

Precise and unambiguous definition of the reference system with the relevant algorithm and formulas to transform any referential (astronomic, geodetic, local, object) plus the best quality of the tooling and the instrumentation have to be considered both when a large-dimension and high-precision project is concerned: particle accelerators, large physics experiments, nuclear plants, any sen-





Fig. XII. Socket for laboratory metrology and specific gauge (CERN TS-SU-EM library)



Fig. XIII. Particle beam transfer lines (CERN TS-SU library)

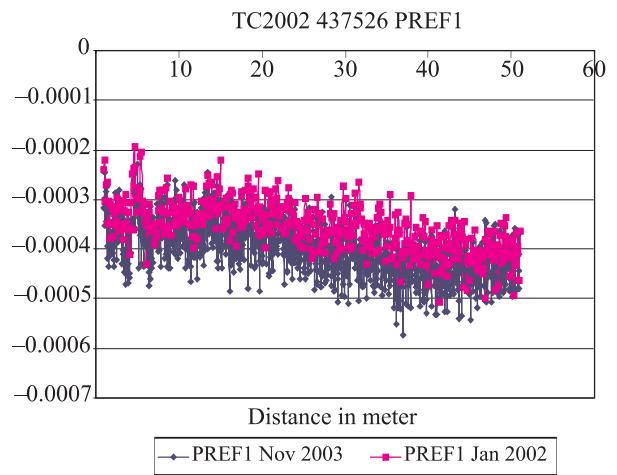

Fig. XIV. Measure chariot of the calibration bench at CERN (CERN TS-SU library) and result of an electro-optic distance-meter calibration

sitive installations to critical, long-term or not, deformations or vibrations, specifically when individual positioning depends on several interrelated or correlated and non independent steps one from another (accelerator, beam lines) (see Fig. XIII).

The environment is always an important parameter: meteorological effects, temperature and humidity gradients, air draughts, must be recorded and modeled, relevant actions and corrections have to be taken. Stability of the supporting structure of the instrumentation has to be proved or cross-checked by independent means regularly.

Finally but related to the ultimate result of a process, since newly high accurate metrology devices are of elec-

tronic or even photonique techniques, appropriate calibrations must be defined, applied regularly and adapted to each type of measures (see Fig. XIV).

A last point not detailed here is the necessity of a versatile data-taking and three-dimensional adjustment software with facilities of treating conventional and specific types of measures (offsets, earth model corrections, etc.), analyzing measures and results under various calculations hypotheses (with/without constraints, different datums, estimation of internal and external robustness, errors detection, simulation, estimation of statistical «producer and consumer» risks) plus estimating deformations (most probable datum, Kalman filtering) with statistical smoothing lines and shaping objects.

## REFERENCES

1. *Herty A., Albert J.* High Precision Survey and Alignment of Large Linear Colliders — 2D Horizontal Alignment // Proc. of the Seventh Intern. Workshop on Accelerator Alignment, Spring8, Japan, November 2002.
2. *Quesnel J.-P.* A Strategy for the Alignment of the LHC // IWAA-2004, CERN, Geneva, 4–7 October 2004.
3. *Redaelli S.* Alignment and Stabilization Issues in Linear Colliders // IWAA-2004, CERN, Geneva, 4–7 October 2004;  
*Prenting J., Schlösser M. et al.* High Precision Survey and Alignment of Large Linear Accelerators // XXII Intern. Linear Accelerator Conference (LINAC-2004), Lübeck, Germany, August 2004.
4. *Schlösser M.* The Rapid Tunnel Reference Surveyor for a Future Linear Collider // IWAA-2004, CERN, Geneva, 4–7 October 2004.
5. *Herty A., Green J., Grzelak G., Mitra A., Prenting J., Reichold A., Schloesser M.* High Precision Survey and Alignment of Large Linear Accelerators // IWAA-2004, CERN, Geneva, 4–7 October 2004.
6. *Coosemans W.* // Proc. of the Third Intern. Workshop on Accelerator Alignment, Annecy, France, Sept. 28 – Oct. 1, 1993. P. 223–240;  
*Ruland R. E. et al.* // Ibid. P. 251–252;  
*Wilson I.* CERN SL/92-41.
7. *Jeanneret J.-B.* Alignment in Circular Colliders and Specific Requirements for LHC // IWAA-2004, CERN, October 2004.
8. *Bowden G.* Stretched Wire Mechanics // IWAA-2004, CERN, Geneva, 4–7 Oct. 2004.
9. *Panofsky W. K. H.* The Use of a Magnetic Pickup as an Alignment Indicator with a Stretched Wire Technique. Tech. Note TN-65-74, Stanford Linear Accelerator Ctr., September 1965.
10. *Schwarz W.* Wire Measurement for the Control of ffb-Magnets // 2nd Intern. Workshop on Accelerator Alignment, Hamburg, 1990. P. 469–480.
11. *Orazio S.* Principles of Lasers, 4th ed. (trans. David Hanna), Springer, 1998.
12. *Siegman A. E.* Lasers, University Science Books. 1986.
13. *Saleh B. E. A., Teich M. C.* Fundamentals of Photonics. Wiley, 1991.
14. *Siegman A. E.* Defining, Measuring, and Optimizing Laser Beam Quality // Proc. SPIE, 1993. V. 2. P. 1868.
15. [http://www.roithner-laser.com/Silicon\\_PD.html](http://www.roithner-laser.com/Silicon_PD.html)
16. <http://www.edmundoptics.com/onlinecatalog/DisplayProduct.cfm?productid=2472>
17. <http://www.edmundoptics.com/onlinecatalog/displayproduct.cfm?productID=2552>
18. *Hecht J.* Understanding Fiber Optics, 4th ed., Prentice-Hall, Upper Saddle River, NJ, USA, 2002.
19. Micro-g LaCoste, Inc. Absolute Gravimeter Workshop Lafayette, Colorado, USA, 11–15 September, 2006.
20. <http://www.microglacoste.com/fg5specs.htm>
21. *Born M., Wolf E.* Principles of Optics: Electromagnetic Theory of Propagation, Interference and Diffraction of Light. New York: Cambridge U.P., 1999.
22. *Hecht J.* City of Light. The Story of Fiber Optics. Oxford University Press, 1999.
23. *Fujimay I., Iwasaki S., Seta K.* High-Resolution Distance Meter Using Optical Intensity Modulation at 28 GHz // Meas. Sci. Technol. 1998. V. 9. P. 1049–1052.

24. *Fabre C., Fouet J. B., Maitre A.* // Opt. Lett. 1999. V. 25. P. 76.
25. *Treps N. et al.* A Quantum Laser Pointer // Science. 2003. V. 301. P. 940.
26. *Batusov V. et al.* A Study of an Air Medium Influence on the Rectilinearity of Laser Ray Proliferation towards the Using for Large Distances and High Precision Metrology // Part. Nucl., Lett. 2007. V. 4, No. 1(137). P. 150.
27. *Altamini Z.* Reference Systems: Definition and Realization // AFREF Technical Workshop, University of Cape Town, July 9–13, 2006.
28. Reference Coordinate Systems.  
<http://maite152.upc.es/~manuel/tdgps/node17.html>
29. *Dana P. H.* Geodetic Datum Overview.  
<http://www.colorado.edu/geography/gcraft/notes/datum/datum.html>
30. *Grote H.* Global Reference System.  
[http://mad.home.cern.ch/mad/Introduction/global\\_system.html](http://mad.home.cern.ch/mad/Introduction/global_system.html)
31. *Lasseur C.* Introduction to Survey and Alignment Techniques. <https://edms.cern.ch/document/527405/1>
32. *Bensinger J. et al.* High Precision Optical Instrumentation for Large Structures Position Monitoring: The BCAM System Applied to the CMS Magnet. <https://edms.cern.ch/document/777593/2>

Received on July 2, 2007.

Батусов В. и др.

E13-2007-98

Применение лазерного пучка в качестве координатной оси в метрологических целях

Рассмотрена возможность использования коллимированного луча одномодового лазера в качестве координатной оси. Предложены методы формирования «продленного» лазерного луча и его применения в качестве весьма протяженной координатной оси.

Работа выполнена в Лаборатории ядерных проблем им. В. П. Джелепова ОИЯИ.

Препринт Объединенного института ядерных исследований. Дубна, 2007

Batusov V. et al.

E13-2007-98

On a Laser Beam Fiducial Line Application for Metrological Purposes

The possibility of a collimated one-mode laser beam used as a fiducial line is considered. The technology of an «extended» laser beam formation and application for a much extended fiducial line is proposed.

The investigation has been performed at the Dzhelepov Laboratory of Nuclear Problems, JINR.

Preprint of the Joint Institute for Nuclear Research. Dubna, 2007