

ANNUAL REPORT

JOINT INSTITUTE FOR NUCLEAR RESEARCH

2002



Joint Institute for Nuclear Research

Phone: (7-09621) 65-059

Fax: (7-095) 975-23-81

Telex: 911621 DUBNA SU

E-mail: post@office.jinr.dubna.su

Address: JINR, 141980 Dubna, Moscow region, Russia

CONTENTS

| | |
|---|-----|
| INTRODUCTION | 5 |
| GOVERNING AND ADVISORY BODIES OF JINR | |
| Activities of JINR Governing and Advisory Bodies | 9 |
| Prizes and Grants | 27 |
| INTERNATIONAL RELATIONS AND SCIENTIFIC COLLABORATION | |
| Collaboration in Science and Technology | 31 |
| RESEARCH AND EDUCATIONAL PROGRAMMES OF JINR | |
| Bogoliubov Laboratory of Theoretical Physics | 51 |
| Veksler and Baldin Laboratory of High Energies | 59 |
| Laboratory of Particle Physics | 69 |
| Dzhelepov Laboratory of Nuclear Problems | 77 |
| Flerov Laboratory of Nuclear Reactions | 88 |
| Frank Laboratory of Neutron Physics | 99 |
| Laboratory of Information Technologies | 107 |
| Division of Radiation and Radiobiological Research | 115 |
| University Centre | 120 |
| CENTRAL SERVICES | |
| Publishing Department | 127 |
| Science and Technology Library | 128 |
| Intellectual Property, Licensing and Standardization Office | 129 |
| Experimental Workshop | 130 |
| ADMINISTRATIVE ACTIVITIES | |
| Financial Activities | 133 |
| Staff | 134 |

JINR MEMBER STATES

Republic of Armenia
Republic of Azerbaijan
Republic of Belarus
Republic of Bulgaria
Republic of Cuba
Czech Republic
Georgia
Republic of Kazakhstan
Democratic People's Republic of Korea
Republic of Moldova
Mongolia
Republic of Poland
Romania
Russian Federation
Slovak Republic
Ukraine
Republic of Uzbekistan
Socialist Republic of Vietnam

INTRODUCTION

In the year 2002, active research was done in main, most perspective for JINR trends of the scientific programme, including nuclear physics and elementary particle physics, condensed matter physics with neutrons, radiobiological research and a programme in higher education.

Unique scientific and technical work was continued in 2002 to make the slow extraction of the charged particle beam from the Nuclotron. For the first time, superconducting lenses and the superconducting extraction magnet were applied. Working beams of a wide ion spectrum in the large energy range with good time structure and beam homogeneity coefficient were obtained. A complex solution of the task of the slow resonance beam extraction from the superconducting accelerator was achieved for the first time in the world practice. A dramatic result was reached in the December Nuclotron run: a polarized deuteron beam was accelerated up to 2 GeV/nucleon and extracted from the Nuclotron. It opens up fresh opportunities for research.

Experiments to synthesize element 118 were conducted at the Dubna gas-filled recoil separator. The events observed are tentatively classified as a decay of a new superheavy element with $Z = 118$ and $A = 294$, which appears in the full fusion $3n$ -evaporation reaction with a cross section of about 0.5 pb.

In the framework of the DRIBs project (production of radioactive ion beams at Dubna cyclotrons), unique equipment was manufactured and the amalgamation of the first-class cyclotrons U400M and U400 was realized. As a result, remarkable methods to obtain radioactive beams were realized at the new facility. A radioactive beam of ${}^6\text{He}$ was transported from the U400M cyclotron hall to a distance of 120 m and accelerated up to an energy of 15 MeV/A.

It was shown in theoretical studies by the Institute theorists that the excess of positrons in cosmic rays observed by the HEAT (High-Energy Antimatter Telescope) and AMS (α -Magnetic Spectrometer) collaborations could be explained by the annihilation of

neutralinos from the Dark matter in galactic halo. The estimated neutralino mass ~ 100 GeV is compatible with the global fitting to all low-energy data within the Minimal Supersymmetric Standard Model.

A finite rank separable approximation for particle-hole random phase approximation calculations with Skyrme interactions was extended to take into account the pairing correlations. Thus, a possibility of solving the RPA problem in a very large configuration space appeared. Properties of low-lying quadrupole and octupole vibrational states in nuclei away from stability were studied.

A new S -matrix thermodynamical approach was developed by a group of theorists to describe processes of hadron multiparticle production. Based on this approach, the phenomenon of thermalization of the finite state was predicted in the very high multiplicity region and later confirmed by the preliminary data obtained in STAR experiments (RHIC, BNL).

JINR specialists continue to take part in the high-level experiments at accelerators of such world famous scientific centres as CERN, DESY, BNL. With considerable contribution of LPP physicists to the NA48 experiment (CERN), the most precise result on the measurement of the direct CP -violation effect has been obtained from the analysis of data on the decays of neutral kaons into two pions.

A great number of JINR scientists work in the CERN project to prepare LHC experiments. In July, 2002, the last, 65th module for the ATLAS calorimeter was transported to CERN. Thus, JINR concluded the manufacturing and assembly of all modules for the hadron tile-calorimeter.

The iron core, which consisted of 28 modules, was also produced for the dipole magnet of the ALICE facility in the framework of the joint CERN–JINR project.

In 2002 the third movable reflector for the IBR-2 reactor was constructed. The construction and preliminary assembly of the shielding block and other parts of the movable reflector were done at the JINR Exper-

imental Workshop and the N. Dollezhal Research Institute.

Considerable progress was achieved in the IREN project activities: the dismantling of the old linear electron accelerator LIU-30 was finished and the construction of a new linear accelerator was started.

New studies on biophysics of photobiological processes were started in the Division of Radiation and Radiobiological Research. Vital issues of photobiology will be studied at JINR basic facilities.

In 2002, work to create the JINR GRID segment and to incorporate it into the global GRID structure was actively carried out. The monitoring system operates in a test mode; its experimental use for the CMS, ALICE, ATLAS experiments is in progress.

Medicobiological and clinical research was successfully conducted in treatment of oncological diseases on the basis of the medicotechnical complex and medical hadron beams from the JINR Phasotron. In 2002 these studies were supported financially in the framework of the Russian programme «Dubna — a Science City».

The educational programme was also fruitful. In 2002 more than 200 students from the Member States attended the UC courses. Within a new programme for the IBR-2 specialists' training, about 100 students were trained on the basis of the Dubna department of MIREA.

Much progress was made in the reported year in the development and strengthening of international scientific cooperation of JINR with different countries. Negotiations of the JINR Directorate with leading US science organizers resulted in activities to prepare the text of a full-scale agreement between the Department of Energy of the USA and JINR. A new page in the development of JINR contacts with scientific centres in China were bilateral meetings of the JINR leaders with Chinese leaders of the Ministry of Science and Technology of China: chances to re-establish the membership of China at JINR were discussed. Cooperation with India was also in progress: Director of the Centre of New Technologies Professor D. Bhavalkar informed the JINR Directorate, during his visit to Dubna in September, 2002, about the consent of the Department of Atomic Energy of India and the Department of Science and Technology of the Indian Government to conclude

an agreement on the participation of India in the activities of JINR.

One of the results of the visit of the JINR delegation to Madrid was the elaboration of protocols on the cooperation of JINR with the Institute of the Matter Structure and the Institute of Mathematical and Fundamental Physics.

Numerous conferences, schools and seminars were held in 2002, including those in Greece, Mongolia, Romania, Slovakia and Ukraine. A traditional joint CERN–JINR exhibition «Science Bringing Nations Together» was held in Bucharest. Its touring around the world will be continued in Yerevan in 2003.

In November, Chairman of the Federation Council of the RF Federal Assembly S. Mironov visited Dubna and JINR. The aim of his visit was to become acquainted with the Dubna experience in the development of the innovation economy, science and education. In the end of December, First Deputy Minister for Foreign Affairs of Russia, a special representative of the RF President in the rank of a Federal Minister in states — members of CIS V. Trubnikov visited JINR. He was accompanied by Yu. Baturin, a Russian cosmonaut and politician.

A remarkable event of the year was the international conference «Intellectual Bridge Russia–the West. Problems and Prospects», which took place in Dubna in the last days of December. Among the organizers of the conference was the Joint Institute for Nuclear Research. Russian scientists who worked abroad, representatives of Russian science cities and research centres of the Moscow Region were invited to take part in the conference. The event can be regarded as one more example of JINR's interactions with Russian colleagues in other countries in the framework of wide international cooperation, and its aim was to consolidate efforts of Russian scientists in the world to establish and bring into life concrete projects and programmes.

The year 2002 was marked at the Joint Institute for Nuclear Research by the preparation of a draft programme for the development of JINR in the coming seven years, from 2003 to 2009. This programme shows the participation of JINR scientists in large international projects and contains duties for the Institute Member States to produce basic and experimental facilities of the world class quality.

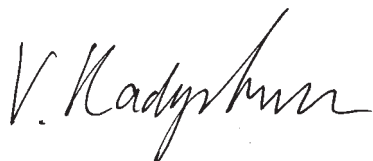

V. G. Kadyshevsky
Director
Joint Institute for Nuclear Research

GOVERNING AND ADVISORY BODIES OF JINR



ACTIVITIES OF JINR GOVERNING AND ADVISORY BODIES

SESSION OF THE JINR COMMITTEE OF PLENIPOTENTIARIES

A regular session of the Committee of Plenipotentiaries of the Governments of the JINR Member States was held in Dubna on 21–22 March.

Academician M. P. Kirpichnikov (Russian Federation) was elected Chairman of the session of the Committee of Plenipotentiaries (CP).

The CP took note of the report presented by JINR Director V. G. Kadyshevsky on implementation of the recommendations of the Scientific Council and of the decisions of the CP, on JINR's activities in 2001 and plans for 2002.

The CP approved the JINR Directorate's activities on implementation of the research programme in 2001 and on the execution of the reform programme of JINR. The CP also approved the recommendations of the 90th and 91st sessions of the JINR Scientific Council and the JINR Topical Plan of Research and International Cooperation for 2002.

In line with the recommendations of the 91st session of the JINR Scientific Council (17–18 January 2002), the CP commissioned the JINR Directorate to give priority funding in 2002 to the following activities:

- improvement of the Nuclotron beam extraction system and of external beam lines, further improvement of the accelerated and extracted beam parameters, achievement of a wider range of accelerated particles and nuclei for the users, operation and development of the Nuclotron, and further reduction of electric power consumption for its operation;
- modernization of the IBR-2 reactor according to the schedule of activities approved by the Agreement between JINR and the Russian Ministry of Atomic Energy: construction of the new movable reflector, replacement of the reactor core, manufacturing of the reactor's new fuel loading, and replacement of the cryogenic facility;
- start of physics experiments with radioactive ion beams, completion of Phase I of the Dubna Radioactive Ion Beams (DRIBs) project, implementation of work on the realization of Phase II of the project;
- decommissioning of the IBR-30 reactor and construction of the IREN facility according to the revised schedule of January, 2002, and dedicated funding with a view to completing its first stage in 2003;
- further development of JINR's telecommunication links and computing and networking infrastructure;
- theoretical studies in particle physics and quantum field theory, nuclear physics, and condensed matter physics, also with a view to supporting experimental work in these fields;
- continued participation in frontier experiments aimed at studying the fundamental properties of elementary particles and their interactions, amongst others at accelerator facilities at IHEP (Protvino), CERN, DESY, BNL and FNAL;
- experiments on the synthesis of superheavy nuclei with $Z = 115$ and 118 using the upgraded Gas-Filled Recoil and VASSILISSA separators, experiments on the chemical isolation and identification of superheavy elements with $Z = 112$ and 114 , study of the fusion–fission reactions with ^{48}Ca , ^{58}Fe , ^{64}Ni ions using the CORSET+DEMON

facility, study of the structure of light exotic nuclei and of the mechanism of nuclear reactions with radioactive and stable ion beams using the ACCULINNA, COMBAS, MSP-144 and ISTR A set-ups, construction of the MASHA separator;

- continuation of relativistic nuclear interaction studies focused on the search for manifestations of quark and gluon degrees of freedom in nuclei and asymptotic laws for nuclear matter at high energies, as well as studies of the spin structure of the lightest nuclei; in-house experiments, mainly at the Nuclotron, as well as experiments at accelerators of other centres: CERN (SPS, LHC), BNL (RHIC), GSI (SIS), Uppsala University (CELSIUS), RIKEN, and DESY (HERA);
- development of instrumentation and data acquisition equipment for spectrometers at the IBR-2 reactor to make possible a cold neutron programme, improvement of detectors for research with IREN;
- development of the JINR Educational Programme, including special-purpose training of specialists for the Member States;
- further R & D of accelerator subsystems for the LHC and linear colliders TESLA and CLIC as well as development of promising accelerator technologies;
- investigation of genetic effects induced in biological objects by ionizing radiation with different linear energy transfers, continuation of the development of new radiopharmaceuticals for cancer diagnostics and treatment.

Based on the report presented by JINR Assistant Director for Economic and Financial Issues V. V. Katrasev, the CP took note of the information on the execution of the JINR budget in 2001, approved the JINR budget for 2002 with a total expenditure of US\$ 37.5 million and the Member States' contributions to the budget for 2002. The estimate of the JINR budget for 2003 in income and expenditure was set by the CP to be US\$ 37.5 million. Also fixed was the provisional determination of the Member States' contributions paid to the budget in 2003.

The CP commissioned the Directorate to work out measures aimed at increasing the number of personnel of the national groups from the Member States working at JINR.

The CP took note of the report presented by A. I. Volodin on the meeting of the Finance Committee held on 21–22 February 2002, approved the Finance Committee's Protocol and the Directorate's report on the execution of the JINR budget in 2000.

Based on the proposal presented by Plenipotentiary of the Russian Federation M. P. Kirpichnikov on accounting for the special-purpose funding of JINR scientific projects, the CP took the following decision:

- considering the special feature of JINR financing by the Russian Federation as the host country of the Institute, the JINR Directorate is allowed, beginning from the year 2001, to include the funds received from the Russian state institutions and organizations for financing JINR's specific scientific projects and activities in the actually paid contribution of the Russian Federation. These funds will be annually accounted for in the JINR budget as part of the Russian contribution in addition to those paid from the state budget of the Russian Federation for financing JINR or as repayment of the Russian Federation's debts over preceding years;
- in preparing amendments to the JINR Finance Protocol, the Directorate is commissioned to add an item on including the special-purpose financing of JINR scientific projects on account of contributions of the Member States or repayment of their debts.

The CP approved the Directorate's proposal on the preparation of amendments in the normative documents of JINR which regulate its financial activity.

The CP took note of the information presented by JINR Chief Scientific Secretary V. M. Zhabitsky on the appointment by the Plenipotentiaries of Bulgaria and Romania of A. N. Antonov (Bulgaria) and G. Stratan (Romania), respectively, as members of the JINR Scientific Council. Upon proposal by the JINR Directorate, the CP elected M. V. Kovalchuk (Russia), D. L. Nagy (Hungary), and A. Wagner (Germany) as members of the JINR Scientific Council for a term of five years.

The CP thanked the departing member Professor N. Kroo, Secretary-General of the Hungarian Academy of Sciences, for his successful activity over many years as member of the JINR Scientific Council, and satisfied his personal request to leave the Council.

Based on the information presented by JINR Vice-Director A. N. Sissakian and in line with the Scientific Council's recommendation, the CP approved the proposal of the JINR Directorate to name the Laboratory of High Energies after Academicians V. I. Veksler and A. M. Baldin, in recognition of their outstanding contributions to the establishment and development of this Laboratory, its Synchrotron–Nuclotron accelerator complex, and to the activities of the Joint Institute as a whole.

SESSIONS OF THE JINR SCIENTIFIC COUNCIL

The 91st session of the JINR Scientific Council, chaired by JINR Director V.G. Kadyshevsky, took place in Dubna on 17–18 January.

At the session, Academician V. G. Kadyshevsky presented a report on the implementation of the recommendations of the 89th and 90th sessions of the JINR Scientific Council. The Council was informed by JINR Chief Engineer I. N. Meshkov on the status of the operation of the IREN basic facilities and on the construction of the IREN facility, and by FLNR Scientific Leader Yu. Ts. Oganessian on the status of the DRIBs project. Recommendations of the JINR Programme Advisory Committees were presented by T. Hallman, Chairperson of the PAC for Particle Physics, by N. Rowley, Chairperson of the PAC for Nuclear Physics, and by H. Lauter, Chairperson of the PAC for Condensed Matter Physics.

The session included a round-table meeting «Belarus at JINR», whose participants were the Scientific Council members and representatives of Belarusian research centres, universities and organizations. A photo exhibition, dedicated to the cooperation of JINR and Belarus scientists, was also organized.

JINR Vice-Director Ts. Vylov presented the Jury's decision on the JINR prizes for 2001. The decision was taken to confer the titles of «Honorary Doctor of JINR», and the awarding of the 2001 Pontecorvo Prize took place; the laureate delivered a talk on the subject of his research.

The session included elections of the Directors of the Laboratory of High Energies, the Flerov Laboratory of Nuclear Reactions, the Laboratory of Particle Physics, and of a Deputy Director of the Frank Laboratory of Neutron Physics.

Information on longer-range plans of scientific research at JINR in the fields of high-energy physics and condensed matter physics was given by JINR Vice-Director A. N. Sissakian and FLNP Director A. V. Belushkin. A scientific report «Research with Cold Neutrons» was presented by H. Lauter, Chairperson of the PAC for Condensed Matter Physics.

The Scientific Council took note of the comprehensive report presented by JINR Director V. Kadyshevsky on the implementation of the recommendations taken at the 89th and 90th sessions of the Scientific Council. The Scientific Council was pleased to note that its recommendations to the JINR Directorate concerning the Scientific Programme of JINR, the operation and upgrade of the basic facilities, and the construction of new facilities are successfully being implemented, and recognized the significant scientific accomplishments of JINR's international staff of researchers in 2001 in the fields of particle physics, nuclear physics, and condensed matter physics. It was marked that negotiations with the

Government of the Russian Federation on JINR's finances led to a considerable increase of the Institute's personnel salary.

The Scientific Council welcomed the decision of the JINR Directorate to name the Laboratory of High Energies after Academicians V. Veksler and A. Baldin, in recognition of their outstanding contributions to the activities of this Laboratory and of the Joint Institute as a whole.

Round-Table Discussion «Belarus at JINR». The Republic of Belarus has been a Member State of this Institute for many years, playing an important role in the formation of the scientific policy of JINR, in the implementation of its research programme, and in the construction of unique equipment and physics instrumentation for experiments at Dubna and, through JINR, at CERN and FNAL. The reports at the round-table discussion and the scientific-technical and photo exhibitions, dedicated to the event, demonstrated the extensive and fruitful collaboration of JINR with Belarusian research centres and industry. The Scientific Council noted that there were also new opportunities for strengthening this collaboration, in particular in the fields of condensed matter physics and materials science.

The Scientific Council wished that similar presentations concerning scientific and technical cooperation with research centres of the Member States be included in the agenda of future sessions.

The Scientific Council was pleased to note that the operation of the JINR basic facilities in 2001 was according to schedule and that significant progress was achieved in the development and upgrade of the facilities, in particular:

Nuclotron. Three runs of the accelerator were carried out with the total duration of 1330 hours. The intensity and quality of the extracted beams were improved and the range of accelerated particles was increased. The main objectives for the Nuclotron in 2002 should be injection and acceleration of polarized deuterons and further development of the diagnostic systems and beam control at this facility.

IBR-2. The modernization work at the reactor is under way in accordance with the adopted schedule. Some concern was expressed about possible delays; the Scientific Council urges JINR to keep the refurbishment to schedule.

U400 and U400M. The reliable operation of both cyclotrons ensures the implementation of the rich scientific programme on the synthesis of superheavy elements, production of exotic nuclear states, and other studies.

IREN. The progress achieved in the realization of the IREN project in 2001 allows for the possibility of the completion of its first stage in 2003, including com-

missioning of the linear accelerator with beam transport to the target hall. At the same time the Scientific Council noted that there had been a substantial delay of one year in the planned project implementation, resulting from continued financial problems.

Phasotron. The growing interest of users in carrying out experiments with the Phasotron beam was marked. The Scientific Council welcomed further DLNP efforts to widen the experimental programme.

Synchrophasotron. The Scientific Council noted the importance of the ongoing programme of research with polarized deuterons and looks forward to the transition of these experimental studies from the Synchrophasotron to the Nuclotron in 2003.

The Scientific Council took note of the report «Status of the DRIBs Project» presented by FLNR Scientific Leader Yu. Oganessian and congratulated the Flerov Laboratory on the timely and successful launching of the first part of the RIB accelerator complex, resulting in the production of the ${}^6\text{He}$ beam.

The Scientific Council took note of the reports presented in written form by the Directors of the JINR Laboratories as well as suggestions concerning the JINR Scientific Programme based on a three-year plan of activities, and endorsed «The JINR Topical Plan for Research and International Cooperation in 2002». It asked that a list of publications (refereed journals, conferences, PhD theses) should be associated to these reports in the future.

Taking into account these proposals and the recommendations of the PACs, the Scientific Council endorsed the following priority activities in 2002:

- improvement of the Nuclotron beam extraction system and of external beam lines, further improvement of the accelerated and extracted beam parameters, achievement of a wider range of accelerated particles and nuclei for the users, operation and development of the Nuclotron, and further reduction of electric power consumption for its operation;
 - modernization of the IBR-2 reactor according to the schedule of activities approved by the Agreement between JINR and the Russian Ministry of Atomic Energy: construction of the new movable reflector, replacement of the reactor core, manufacturing of the reactor's new fuel loading, and replacement of the cryogenic facility;
 - start of physics experiments with radioactive ion beams, completion of Phase I of the Dubna Radioactive Ion Beams (DRIBs) project, implementation of work on the realization of Phase II of the project;
 - decommissioning of the IBR-30 reactor and construction of the IREN facility according to the revised schedule of January 2002 and dedicated funding with a view to completing its first stage in 2003;
 - further development of JINR's telecommunication links and of JINR's computing and networking infrastructure;
 - theoretical studies in particle physics and quantum field theory, nuclear physics, and condensed matter physics, also with a view to supporting experimental work in these fields;
 - continued participation in frontier experiments aimed at studying the fundamental properties of elementary particles and their interactions, amongst others at accelerator facilities at IHEP (Protvino), CERN, DESY, BNL and FNAL;
 - experiments on the synthesis of superheavy nuclei with $Z = 115$ and 118 using the upgraded Gas-Filled Recoil and VASSILISSA separators, experiments on the chemical isolation and identification of superheavy elements with $Z = 112$ and 114 , study of the fusion–fission reactions with ${}^{48}\text{Ca}$, ${}^{58}\text{Fe}$, ${}^{64}\text{Ni}$ ions using the CORSET+DEMON facility, study of the structure of light exotic nuclei and of the mechanism of nuclear reactions with radioactive and stable ion beams using the ACCULINNA, COMBAS, MSP-144 and ISTR A set-ups, construction of the MASHA separator;
 - continuation of relativistic nuclear interaction studies focused on the search for manifestations of quark and gluon degrees of freedom in nuclei and asymptotic laws for nuclear matter at high energies, as well as studies of the spin structure of the lightest nuclei; in-house experiments, mainly at the Nuclotron, as well as experiments at accelerators of other centres: CERN (SPS, LHC), BNL (RHIC), GSI (SIS), Uppsala University (CELSIUS), RIKEN, and DESY (HERA);
 - development of instrumentation and data acquisition equipment for spectrometers at the IBR-2 reactor to make possible a cold neutron programme such as given in the section under the heading «Condensed Matter Issues»; improvement of detectors for research with IREN.
- Other items that deserve attention were:
- development of the JINR Educational Programme, including special-purpose training of specialists for the Member States;
 - further R & D of accelerator subsystems for the LHC and linear colliders TESLA and CLIC as well as development of promising accelerator technologies;
 - investigation of genetic effects induced in biological objects by ionizing radiation with different linear energy transfers, continuation of the development of new radiopharmaceuticals for cancer diagnostics and treatment.

In response to its previous recommendation, the Scientific Council was informed at this session on the Institute's first preliminary long-range plans of scientific research in the fields of high-energy physics and con-

densified matter physics. The Scientific Council invited the JINR Directorate to present at its 93rd session a Draft Scientific Programme of JINR for the next seven years, followed by discussions at meetings of the PACs and sessions of the Scientific Council. In addition, the Scientific Council would like to receive a proposal, including a long-term scientific programme for planned developments of the in-house facilities.

The Scientific Council took note of and concurred with the recommendations made by the PACs at their November 2001 meetings and presented by their Chairpersons.

Particle Physics Issues. The Scientific Council noted with satisfaction the fundamental results on CP violation of the NA48 experiment at CERN. These results were obtained with active participation of LPP physicists at all stages of the experiment. The Scientific Council welcomed the participation of BLTP physicists in theoretical studies relevant to the CDF, D0 and STAR research programmes.

The Scientific Council took note of the list of the activities suggested for implementation with first priority in 2002–2004 and agreed with the closure of a number of research projects, as detailed in the minutes of the meeting of the PAC for Particle Physics. It expressed, however, concern about the participation in many experiments and the tendency to diversify too much.

The Scientific Council noted with satisfaction the continued progress towards making the Nuclotron a user facility which would add significantly to the suite of accelerator facilities available to the world community for the study of QCD and strong interaction physics. The Scientific Council concurred with the PAC's invitation to the LHE Directorate to develop a strategic coordinated plan for the scientific and technical programme for the Nuclotron up to the end of 2005.

Nuclear Physics Issues. The Scientific Council applauded the recent results on the synthesis of element 116 at FLNR. The observation of three events of the element $Z = 116$ and the consistent detection of the sequential decays (α -chain and spontaneous fission) convincingly confirm the earlier identification of elements with $Z = 114, 112$ and 110 . The Scientific Council strongly recommended the continuation of efforts focused on the $Z = 118$ element, whose observation should help to locate the proton closed shell for the island of stability. The Scientific Council also supported further efforts to investigate chemical properties of the superheavy elements. It also strongly encouraged the development of the MASHA mass separator, which would allow precise mass identification ($\Delta A \approx 0.3$) for superheavy isotopes.

The Scientific Council noted with satisfaction that the assembly of Phase I of the DRIBs project had been completed within the planned period of time. Appropriate financing in 2002 was requested for the timely realization of this second phase of the DRIBs project in

2003, consisting in the production of low-energy separated fission fragments.

The Scientific Council appreciated the progress made in the implementation of the IREN project. It supported the proposal of the project management to ensure the realization of different parts of the project by carrying them out in parallel. This concerns the decommissioning of IBR-30, the licensing of IREN, and the start-up of the first stage of the linac LUE-200 by mid-2003. Therefore the Scientific Council strongly recommended that every possible effort be made to keep the project on schedule leading to operational start-up by the end of 2003.

Condensed Matter Physics Issues. The Scientific Council considered the exploitation of cold neutrons to be of great interest to JINR. It requested the JINR Directorate to follow up this issue as a priority matter. The shortfall in general funding for the IBR-2 reactor, which may delay the project, should be fully recovered.

The run-time of 600 hours per year up to 2007 of the actual cold source is too short to guarantee sufficient scientific output. The development programme, which should result in the supply of an optimized neutron spectrum for nearly each of the spectrometers at the IBR-2 reactor, should be launched.

A «realistic programme» of instrumentation on the cold source is in the following state: the HRFD diffractometer can already take advantage from the BBS in the present configuration; the performance of the small-angle spectrometer YuMo can be improved with cold neutrons if the position-sensitive detector can be realized in 2002.

Common Issues. The Scientific Council again pointed out that the JINR local area network (LAN) and external networking were important basic facilities, and stressed the importance of proper funding for these essential activities. In the present critical situation, urgent recovery of the LAN with adequate financing is of utmost importance. The steps proposed to improve LAN security were also recommended.

The Scientific Council recognized the importance of theoretical research done at BLTP and recommended a better funding for travel and international exchange.

Upon proposal by the JINR Directorate, the Scientific Council appointed the following new members of the PAC for Condensed Matter Physics: P. Alexeev (ISSP, RRC «Kurchatov Institute», Moscow, Russia), R. Cywinski (University, Leeds, UK), S. Kozubek (IB, Brno, Czech Republic). The Scientific Council thanked Professors J. B. Forsyth, M. Kovalchuk, A. Lesnikovich, and V. Somenkov for their highly efficient and successful work as members of the PAC for Condensed Matter Physics.

The Scientific Council elected by ballot:

- M. Itkis as Director of the Flerov Laboratory of Nuclear Reactions for a term of five years,

GOVERNING AND ADVISORY BODIES OF THE JOINT INSTITUTE FOR NUCLEAR RESEARCH

COMMITTEE OF PLENIPOTENTIARIES OF THE JINR MEMBER STATES

| | | | |
|-------------------------|-------------------|-----------------|--------------------|
| Armenia | H. A. Vartapetian | Moldova | V. A. Moskalenko |
| Azerbaijan | N. A. Guliev | Mongolia | Ts. Ganzog |
| Belarus | A. I. Lesnikovich | Poland | A. Hrynkiewicz |
| Bulgaria | E. Vapirev | Romania | D. Popescu |
| Cuba | D. Codorniu | Russia | M. P. Kirpichnikov |
| Czech Republic | R. Mach | Slovak Republic | S. Dubnička |
| Georgia | N. S. Amaglobeli | Ukraine | B. V. Grinev |
| Kazakhstan | K. K. Kadyrzhanov | Uzbekistan | B. S. Yuldashev |
| D. P. Republic of Korea | Li Je Sen | Vietnam | Nguyen Van Hieu |

Finance Committee

One delegate
from each Member State

SCIENTIFIC COUNCIL

Chairman: V. G. Kadyshesky

Scientific Secretary: V. M. Zhabitsky

| | | | | | |
|--------------------|-------------------------|-------------------|-------------|-------------------|-----------------|
| N. S. Amaglobeli | Georgia | A. A. Logunov | Russia | S. K. Rahmanov | Belarus |
| I. Antoniou | Belgium | L. Masperi | Brazil | Š. Šaro | Slovak Republic |
| A. N. Antonov | Bulgaria | M. Mateev | Bulgaria | H. Schopper | Switzerland |
| Ts. Baatar | Mongolia | V. A. Matveev | Russia | N. M. Shumeiko | Belarus |
| A. Budzanowski | Poland | G. van Middelkoop | Netherlands | A. N. Sissakian | Russia |
| N. A. Chernoplekov | Russia | R. Mir-Kasimov | Azerbaijan | A. N. Skrinsky | Russia |
| Choi Jae Gon | D. P. Republic of Korea | V. A. Moskalenko | Moldova | R. Sosnowski | Poland |
| M. Della Negra | Switzerland | T. M. Muminov | Uzbekistan | P. Spillantini | Italy |
| C. Détraz | France | D. Nagy | Hungary | G. Stratan | Romania |
| F. Dydak | Switzerland | Nguyen Van Hieu | Vietnam | A. N. Tavkhelidze | Georgia |
| J. Ganzorig | Mongolia | V. N. Okolovich | Kazakhstan | I. N. Vishnevsky | Ukraine |
| A. Hrynkiewicz | Poland | Yu. A. Osipian | Russia | A. Wagner | Germany |
| J. Janik | Poland | V. V. Papoyan | Armenia | I. Wilhelm | Czech Republic |
| M. V. Kovalchuk | Russia | B. Peyaud | France | B. S. Yuldashev | Uzbekistan |
| F. Lehar | France | G. Piragino | Italy | G. M. Zinovjev | Ukraine |

Programme Advisory Committee for Particle Physics

Chairperson: T. Hallman (USA)
Scientific Secretary: Yu. A. Gornushkin

Programme Advisory Committee for Nuclear Physics

Chairperson: N. Rowley (France)
Scientific Secretary: N. K. Skobelev

Programme Advisory Committee for Condensed Matter Physics

Chairperson: H. Lauter (France)
Scientific Secretary: S. I. Tyutyunnikov

INTERNAL ORGANIZATION OF THE JOINT INSTITUTE FOR NUCLEAR RESEARCH

DIRECTORATE
Director V. G. Kadyshevsky
Vice-Director A. N. Sissakian
Vice-Director Ts. Vylov
Chief Scientific Secretary V. M. Zhabitsky
Chief Engineer I. N. Meshkov

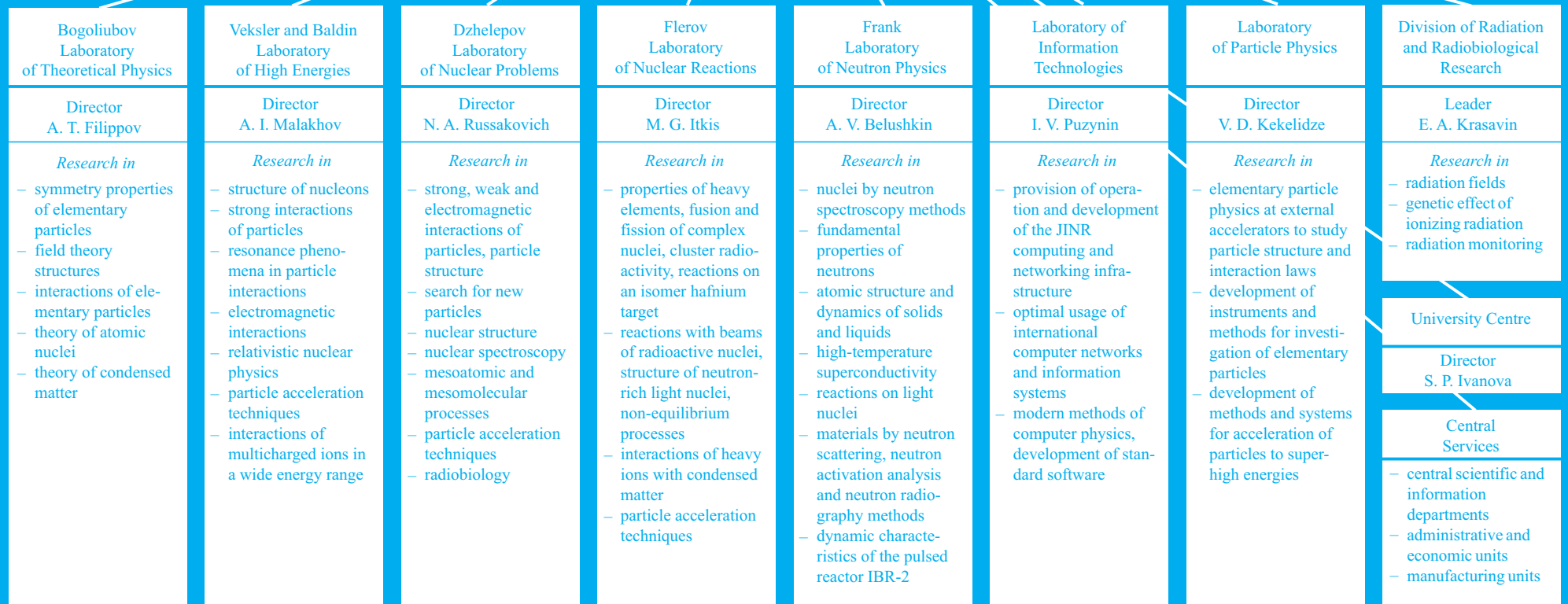

- V. Kekelidze as Director of the Laboratory of Particle Physics for a term of five years,
- A. Malakhov as Director of the Laboratory of High Energies for a term of five years,
- V. Shvetsov as Deputy Director of the Frank Laboratory of Neutron Physics until the completion of the term of office of the FLNP Director.

According to the JINR Regulations, the Scientific Council announced the vacancies of Deputy Directors at VBLHE, LPP, FLNR, and FLNP.

The Scientific Council congratulated Dr N. Samios (BNL, Brookhaven, USA) on being awarded the 2001 Pontecorvo Prize, in recognition of his outstanding contribution to particle physics, and approved the Jury's recommendations on the JINR prizes for 2001 and adopted the recommendations of the Jury on the JINR Prizes for 2001.

The Scientific Council congratulated Professors Ch. Briançon, V. Khalkin, S. Korenchenko, and V. Zinov on being awarded the title «Honorary Doctor of JINR», in recognition of their outstanding contributions to the advancement of science and the education of young scientists.

The 92nd session of the JINR Scientific Council, chaired by JINR Director V. Kadyshevsky, took place in Dubna on 6–7 June.

At the session, Academician V. Kadyshevsky informed the Council about the decisions taken by the JINR Committee of Plenipotentiaries at its meeting held on 21–22 March 2002. JINR Chief Engineer I. Meshkov reported on the status of JINR's basic facilities and activities in accelerator physics and engineering. The recommendations of the JINR Programme Advisory Committees were presented by their Chairpersons: T. Hallman (PAC for Particle Physics), N. Rowley (PAC for Nuclear Physics), and H. Lauter (PAC for Condensed Matter Physics).

In view of the preparation of the Programme of JINR's Scientific Research and Development for the next seven years, the Scientific Council was informed by JINR Vice-Director A. Sissakian on the concept and objectives of this Programme and by the Directorates of the JINR Laboratories on the proposals for the Programme by the fields of research.

The session included elections of Deputy Directors of the Veksler and Baldin Laboratory of High Energies, Flerov Laboratory of Nuclear Reactions, Laboratory of Particle Physics, and the Frank Laboratory of Neutron Physics. According to the JINR Regulations, vacancies were announced in the Directorate of the Laboratory of Information Technologies. On the suggestion by the Directorate, a group of scientists was conferred on the titles of «Honorary Doctors of JINR».

The following scientific talks were delivered at the session: «Study of Nuclear Interactions in the NA49

Experiment» by G. Melkumov and «First Results of Exploration of the Martian surface with the HEND Detector on the U.S. Spacecraft «2001 Mars Odyssey»» by I. Mitrofanov.

The Scientific Council noted the information presented by JINR Director V. Kadyshevsky concerning the decisions taken by the JINR Committee of Plenipotentiaries (CP) at its March 2002 meeting, in particular:

- the approval of the JINR Directorate's activity on the preparation of the Programme of JINR's Scientific Research and Development for the next seven years;
- the approval of the JINR Topical Plan of Research and International Cooperation for 2002 based on the recommendations of the Scientific Council and the PACs;
- the appointment of A. Antonov (INRNE, Bulgaria), M. Kovalchuk (IC, Russia), D. Nagy (KFKI, Hungary), G. Stratan (NIPNE, Romania), and A. Wagner (DESY, Germany) as members of the JINR Scientific Council, continuing the rotation of the Scientific Council members (the general election of the new membership of the Scientific Council is to take place at the CP March 2003 meeting);
- the naming of the Laboratory of High Energies after Academicians V. Veksler and A. Baldin.

The Scientific Council highly appreciated the new steps taken by the JINR Directorate to develop international collaboration with research centres and universities in the Member States and other countries. It was pleased to note the signing of the Agreement between JINR and INFN (Italy), the Joint Statement of Intent between the US Department of Energy and JINR to promote cooperation in science and technology, and the intention of JINR and BMBF (Germany) to prolong the existing Cooperation Agreement. The Scientific Council noted with satisfaction that the latest negotiations with the Government of the Russian Federation had resulted in a regular inflow of the Russian contribution to the JINR budget.

The Scientific Council took note of the report «Status of JINR's Basic Facilities and Activities in Accelerator Physics and Engineering» presented by JINR Chief Engineer I. Meshkov.

Nuclotron. The Scientific Council was satisfied to learn about the very significant progress achieved in the Nuclotron development — the increase of the run duration up to planned 2000 h/year and improvement of the machine characteristics. However, the Scientific Council considered as an important goal of VBLHE the achievement of the design parameters of the Nuclotron, in particular, the design goals for the extracted ion energy, and delivery of polarized deuterons.

IBR-2. The refurbishment of the IBR-2 reactor carried out according to schedule is an important future task of JINR. The construction of the modernized cold source is also very important. The Scientific Council

noted with satisfaction the support of the Russian Ministry of Atomic Energy provided to help carry out this project.

U400 and U400M. Stable, quality operation of the FLNR cyclotrons affords the possibility of performing pioneering experiments on the production and study of superheavy elements and exotic nuclei. The significant progress in the implementation of the DRIBs project also allows for the possibility of a wide experimental programme in nuclear physics in the near future.

Phasotron. The operation and upgrades of the Phasotron provides DLNP with a proton beam which can be used for different studies in intermediate-energy physics and applied research.

IREN. The implementation of the IREN project, delayed due to lack of funding, is nevertheless progressing. The plan to put the linac into operation next year is a necessary step in the project completion.

In line with the Scientific Council's recommendations, the JINR Directorate is developing the Programme of JINR's Scientific Research and Development for the next seven years (2003–2009). The Scientific Council took note of the concept and objectives of this Programme presented by JINR Vice-Director A. Sissakian and of the proposals for the Programme by the fields of research presented by the Directors or Deputy Directors of the JINR Laboratories. The Scientific Council sees the seven-year plan as offering a strong opportunity for the JINR Directorate to define its future strategy and to spell out its scientific priorities for developing the international reputation of the Institute. This document should focus, in particular, on the financial and human resources available to complete large-scale projects, attractive to young scientists, on a realistic time scale.

The Scientific Council took note of and concurred with the recommendations made by the PACs at their April 2002 meetings and presented by their Chairpersons.

Particle Physics Issues. The Scientific Council supported the recommendation of the PAC for Particle Physics concerning the long-term plan of physics research at the Nuclotron. The PAC continued to be concerned that the main physics drivers for the Nuclotron need to be identified along with a corresponding plan for a limited number of first-line experimental facilities to achieve this programme.

The Scientific Council recommended that the JINR Directorate provide adequate support for scientists working at the Nuclotron to encourage active scientific participation of young scientists in this programme.

The Scientific Council shared the PAC's concern that further advances were necessary in the development of JINR's networking and computing infrastructure to help ensure the success of the JINR scientific programme, in particular for large international collaborative efforts such as those at the LHC. It strongly recommended that the JINR Directorate provide the nec-

essary support to allow for continued improvement of this infrastructure.

The Scientific Council noted the extensive and high-quality research programmes in accelerator physics and engineering under way at JINR. The Scientific Council concurred with the PAC that the manpower and resources for realization of these programmes seemed to be thinly spread between the Laboratories and their research activities, and recommended that project teams be established as a means to concentrate effort on the main goals of the development of the JINR basic facilities.

The Scientific Council endorsed the recommendations of the PAC for Particle Physics on the execution of the new scientific projects (*NN* Scattering, PIKASO, PHe3, HYPERON-M, TUS), as detailed in the PAC Minutes. The Scientific Council also concurred with the recommendations of the PAC regarding the continuation of ongoing experiments previously approved up to 2002.

Nuclear Physics Issues. The Scientific Council endorsed regular financing of the IREN project and continuous support of the JINR technical services to complete this project as close as possible to the announced date.

The Scientific Council approved the experimental programme presented for stable and light radioactive beams (DRIBs Phase I). It recommended high-priority support of all aspects of the DRIBs project, including its Phase II, modernization of the U400M cyclotron and the development of necessary experimental equipment.

The Scientific Council recommended strong support of the MASHA project which would allow direct mass determinations ($\Delta m/m \approx 0.1\%$) and more detailed studies of chemical and physical properties of superheavy elements.

The Scientific Council awaited the results of a study on the external Phasotron injection and strongly recommended that the impact of significantly greater beam intensities, the resulting activations and induced radiation damage of beam-channel components be investigated. The Scientific Council recommended the creation of an appropriate organization of the proton therapy infrastructure in order to respond to the demands from hospitals.

Condensed Matter Physics Issues. The Scientific Council considered the refurbishment of the IBR-2 reactor to be of basic interest to JINR. The cold source should be considered to be part of the IBR-2 reactor refurbishment:

- the refrigerator belonging to the cold source complex has to be installed in 2004, so that it can be of use for the actual cryogenic moderator and the future cryogenic moderator;
- in view of its lifetime, the actual cryogenic moderator (BBS — Broad-Band Source) can work 3 cycles/year from 2004 to 2007, which represents a reasonable compromise as it will serve

only two spectrometers. However the benefit of the actual BBS can already be fully demonstrated; — the new BBS should already be included in the refurbishment programme, and its planning together with the instrument development programme should be started in 2002.

Common Issues. Research and development should be concentrated on the most advanced and unique projects and installations, backed by strong scientific demands from the JINR Laboratories. Similar considerations must apply to new proposals, such as DELSY and LEPTA, which require comprehensive presentation of their research potential and of the resources to be committed. The remote analysis of external experiments is of vital importance. This requires drastically improving the performance of JINR's networking infrastructure and supporting it with adequate financing.

The Scientific Council thanked Professors T. Hallman, H. Lauter, and N. Rowley for their highly successful work as Chairpersons of the PAC for Particle Physics, PAC for Condensed Matter Physics, and PAC for Nuclear Physics, respectively. Upon proposal by the JINR Directorate, the Scientific Council re-appointed the PAC Chairpersons:

- T. Hallman — for a term of three years,
- H. Lauter — for a term of one year,
- N. Rowley — for a term of two years.

The Scientific Council elected by ballot:

- N. Agapov and S. Vokal as Deputy Directors of the Veksler and Baldin Laboratory of High Energies,
- S. Dmitriev and J. Kliman as Deputy Directors of the Flerov Laboratory of Nuclear Reactions,
- M. Sapozhnikov as Deputy Director of the Laboratory of Particle Physics,
- N. Popa as Deputy Director of the Frank Laboratory of Neutron Physics

until the completion of the terms of office of their respective Laboratory Directors.

According to the Regulations in force, the Scientific Council announced the vacancies of Director and Deputy Directors at the Laboratory of Information Technologies.

The Scientific Council took note of the information by Director V. Kadyshevsky that no candidate for the post of Director of the Bogoliubov Laboratory of Theoretical Physics had been identified yet. After due discussion, the Scientific Council concurred with the proposal by V. Kadyshevsky to appoint Vice-Director A. Sissakian also as Acting Director of BLTP after the completion of the term of duties of the present Director of this Laboratory, i. e., after 16 January 2003.

The Scientific Council congratulated Professors W. Greiner, M. Likhachev, B. Paton, V. Penev, and A. Smirnov on being awarded the title «Honorary Doctor of JINR», in recognition of their outstanding contributions to the advancement of science and the education of young scientists.

MEETING OF THE JINR FINANCE COMMITTEE

Under the chairmanship of the representative of the Russian Federation A. Volodin, a meeting of the JINR Finance Committee was held on 21–23 February in Dubna.

JINR Director Academician V. Kadyshevsky reported about the implementation of the recommendations of the JINR Scientific Council and decisions of the JINR CP, the Institute activities in 2001 and prospects in 2002. The Finance Committee approved the efforts of the JINR Directorate in the fulfillment of the research programme, marked considerable success in the operation of basic facilities and in the implementation of the plan of realization of the Agreement between the Russian Federation and JINR on the location and conditions of JINR activities in the Russian Federation. The proposals of the 91st session of the Scientific Council were approved along with the Directorate's plans to elaborate a seven-year programme of JINR development.

Concerning the report delivered by JINR Assistant Director for Economic and Financial Issues V. Katrasev «On the Implementation of the JINR Budget of 2001, a Draft of the JINR Budget of 2002, on Contributions for 2003», the Finance Committee took note of the information about the fulfillment of the 2001 budget and recommended the Committee of Plenipotentiaries of JINR to adopt the 2002 budget with the total expenditure sum of US\$ 37.5 million.

The results of the work of the Control Board (21–22 June 2001) were presented by the Chairman of the Board, Deputy Chief of a department of the Ministry of Industry, Science and Technology of the Russian Federation V. Drozhenko.

The Finance Committee recommended that CP approve the Directorate's proposal to work out changes in the documentation of JINR Norms of financial activities.

MEETINGS OF THE JINR PROGRAMME ADVISORY COMMITTEES

The 17th meeting of the Programme Advisory Committee for Particle Physics took place on 15–16 April. It was chaired by Professor T. Hallman.

The PAC for Particle Physics noted with interest the information presented by Vice-Director A. Sissakian on the recommendations of the 91st session of the JINR Scientific Council, on the decisions of the March 2002 meeting of the JINR Committee of Plenipotentiaries, and on the preparation of the Programme of JINR's Scientific Research and Development for the next seven years (2003–2009) in the field of high-energy physics.

The PAC noted with satisfaction the decision of the JINR Committee of Plenipotentiaries to name the Laboratory of High Energies after Academicians V. Veksler and A. Baldin in recognition of their outstanding contributions to the development of this Laboratory, its Synchrotron–Nuclotron accelerator complex, and of the Joint Institute as a whole.

The PAC noted with interest the information on the proposals for JINR's Programme of Particle and Relativistic Nuclear Physics Research, presented by BLTP Sector Head A. Efremov, VBLHE Director A. Malakhov, LPP Director V. Kekelidze, DLNP Director N. Russakovich and LIT Director I. Puzynin. The PAC recommended that the JINR Directorate develop a consolidated coherent proposal for presentation at the next PAC meeting.

The PAC was gratified to learn of the prospective plan for the organization, maintenance, and development of the university-type education process at JINR, presented by UC Deputy Director T. Strizh, and expressed its full support of this activity as a means to encourage and invest in young scientists and students. The PAC noted the report by LIT Director I. Puzynin and was gratified to learn of the progress made on JINR's networking and computing infrastructure.

The PAC noted with interest the report by JINR Chief Engineer I. Meshkov on the status of JINR's basic facilities and activities in accelerator physics and engineering. It was gratified to learn that the running time for the Nuclotron had increased significantly last year and noted that further development to improve beam quality and especially to provide beams of polarized deuterons and secondary beams of polarized protons within the current year is a task of the highest priority.

The PAC noted the extensive and high-quality research programmes in accelerator physics and engineering under way at JINR. The recognized expertise of the Institute's accelerator specialists allows the JINR research groups to be successfully involved in international collaborations and projects. The PAC also recommended that project teams be established to concentrate

effort on the main goals of the development of the JINR basic facilities.

The PAC noted with interest the report concerning the long-term plan of physics research at the Nuclotron, presented by VBLHE Director A. Malakhov, and recommended that the main physics drivers for the Nuclotron need to be identified along with a corresponding plan for a limited number of first-line experimental facilities to achieve this programme. The PAC recommended that the JINR Directorate provide adequate support for scientists working at the Nuclotron to encourage active scientific participation by young scientists in this programme.

The PAC reviewed the proposals of new projects and approved the following projects: «Experimental Studies of NN Scattering with Polarized Particles at the VdG Accelerator of Charles University» (NN -interactions project), «Spin Effects of Meson Production at Polarized Nuclei» (PIKASO project), «Probing Short-Range Spin Structure of the Deuteron with Polarized Deuteron Beam and Polarized ^3He Target» (PHe3 project) and «Astrophysical Studies on Space Satellites» (TUS experiment) to be carried out by the end of 2005.

The project «Experimental Study of Meson–Nucleus Interactions with the HYPERON-M Set-up» was recommended for approval with second priority until the end of 2004. The PAC noted with interest the proposal «Beryllium Clustering Quest in Relativistic Multifragmentation» (BECQUEREL project) and invited a presentation on some items at its next meeting.

The PAC took note of the report on JINR's participation in the ALICE project. The PAC highly appreciated the contribution of the JINR group to the preparation of the dipole magnet iron yoke manufacturing process, to the ALICE muon spectrometer software development as well as to muon chamber test beam studies. The PAC noted the delivery of good-quality lead-tungstate crystals for the ALICE photon spectrometer from the Institute of Monocrystals (Kharkov, Ukraine) and the successful production and tests of the prototype time-expansion drift chamber for the TRD detector.

The PAC took note of the report on JINR's participation in the ATLAS project and noted with satisfaction that the construction of the Hadron Scintillation and Liquid Argon Calorimeters is nearing completion according to schedule and that the mass production of the muon chambers and of elements of the Internal Tracker was started. The PAC recommended that the JINR Directorate provide adequate technical and financial support to this activity.

The PAC took note of the report on JINR's participation in the CMS project and noted with satisfac-

tion that the CMS collaboration had entered the first year of the assembly and installation period. Taking into account the importance of the timely production and delivery to CERN in 2002 of the components under responsibility of the JINR–CMS group, the PAC recommended that the JINR Directorate provide adequate technical and financial support to this activity and for the subsequent preparation for the scientific programme.

The PAC reviewed the experiments approved for completion in 2002. The PAC highly appreciated the significant contribution made by the JINR group to the HADES project, including the development and production of high-resolution inner drift chambers, the production of front-end electronics and the development of data analysis software. It recommended extension of this activity with first priority until the end of 2005. The PAC recommended extension of LHE's participation in the CERES/NA45 project with first priority until the end of 2005, on the condition that CERN continues the NA45 programme. The PAC took note of the report on the MARUSYA project and of the difficulties with manpower and support from 2000–2002. The PAC recommended that the scientific interest in this project be consolidated with other projects in the context of establishing a coherent programme for the Nuclotron. The PAC recommended extension of the second-priority project «Leading Particles» until the end of 2005.

The PAC took note of the report on the project «Development of Accelerators for Radiation Technologies» and was pleased to note that the new agreements between JINR and USTC (Hefei, China) and MUS (Tokyo, Japan) enhance the international status of the development of accelerators for radiation technologies and envision financing of this activity from non-budgetary sources in the next three years. The PAC recommended continuation of this activity with second priority until the end of 2005.

The PAC noted with interest the report «Prospects of JINR's Participation in the TESLA Project» and encouraged the interested JINR groups to explore ways in which they can contribute to the detectors, accelerator, and physics programme for this project. A proposal was invited at a future meeting of the PAC.

The PAC highly appreciated the great scientific potential of the BOREXINO experiment from the point of view of studies of the fundamental properties of neutrino, electron and nucleon. It noted that the BOREXINO set-up has a high sensitivity to the electron decay process in SUSY channel $e \rightarrow \gamma + \nu$, as well as to neutrino magnetic moment. The PAC thanked Dr O. Smirnov for this interesting report.

The PAC thanked Professor T. Hallman for his successful work as Chairperson of the PAC for Particle Physics and recommended that the JINR Scientific Council re-appoint him as Chairperson of this PAC for a term of three years.

The 16th meeting of the PAC for Condensed Matter Physics was held on 18–19 April. It was chaired by Dr H. Lauter.

The PAC for Condensed Matter Physics took note of the information presented by V. Zhabitsky about the recommendations and considerations of the 91st session of the JINR Scientific Council (January 2002) concerning this PAC.

The PAC noted the reliable performance of the IBR-2 reactor and its progressing refurbishment programme, presented in the report by V. Ananiev. Once again the PAC appreciated the timely contributed Minatom financial support and expressed its concern about the delay of payment from the JINR budget, leading to significant delays in the development programme. The PAC supported the plans to get new reactor personnel through the payment of compensations and through advantages, e. g., in housing. The PAC recommended that the shortfall in the general funding and in the time schedule should be fully recovered this year. The PAC discussed the cryogenic moderator of the IBR-2, which at the previous meeting was proposed to be named as «broad-band source» (BBS) to describe its advantage more precisely. Note was taken that the implementation of the BBS renewal programme would be presented by A. Belushkin for discussion at the November meeting of the PAC. The PAC considered the reports about the upgrade of the SPN reflectometer and the YuMo small-angle spectrometer, presented by A. Petrenko and A. Kuklin, respectively. The results of upgrading are very important and encouraging.

The following scientific reports were presented at the meeting: «Functional Materials» (R. Cywinski), «Towards 3-Dimensional Polarimetry in Neutron Reflectometry» (B. Toperverg), «Molecular Mechanisms of Visual Reception (Outlook for Research at JINR Basic Facilities)» (M. Ostrovsky), «Proton 3D-Conformal Radiography of Intracranial Tumors in Dubna» (Ye. Luchin), «Radioanalytical Investigations at FLNP: Contribution to Life Sciences at JINR» (M. Frontasyeva). The first three contributions were related to the IBR-2 reactor and should find their outcome in the instrumentation at the IBR-2 reactor and support of the Laboratory Directorate. The following two contributions should equally find support by the Directorates of the corresponding Laboratories.

The PAC took note of the proposals of the Laboratories for the JINR scientific programme in the field of condensed matter physics for the years 2003–2009, presented by A. Belushkin (FLNP), E. Krasavin (DRRR), N. Plakida (BLTP), and S. Dmitriev (FLNR). The PAC supported the presented research programmes. In particular, the research programme around the refurbishment of the IBR-2 reactor with its BBS source, which represents at the same time a user facility as part of the research programme, is a central task at JINR.

The PAC took note of the status of JINR's basic facilities and activities in accelerator physics and engineering, presented by I. Meshkov. The PAC stated that it had still insufficient information to assess the impact of the DELSY project on condensed matter science and invited the authors of the project to present a first stage research programme, being, in particular, complementary between research with neutrons and synchrotron radiation.

The PAC noted the report presented by M. Avdeev on the results of the School on Application of Neutron Scattering and Synchrotron Radiation (8 February – 7 March 2002). The PAC also noted the information presented by M. Balasoiu about the JINR–Romania Workshop on Advanced Materials and their Characterization, which took place on 18–22 March 2002.

The 16th meeting of the Programme Advisory Committee for Nuclear Physics was held on 22–23 April. It was chaired by Professor N. Rowley.

The PAC was informed on the implementation of recommendations taken at the previous meeting, on the resolution of the 91st session of the JINR Scientific Council (January 2002), on the decisions of the Committee of Plenipotentiaries (March 2002), and on the preparation of the Programme of JINR's Scientific Research and Development for the years 2003–2009. The PAC Chairperson congratulated the Flerov Laboratory of Nuclear Reactions on the acceleration of ${}^6\text{He}$ at DRIBs and on its latest results relating to the chemistry of element $Z = 112$.

JINR Basic Facilities. The PAC took note of the report on the status of the JINR basic facilities and was impressed by the wide-ranging high-quality research programme in accelerator physics and engineering. However, in view of a number of upcoming new activities, the PAC expressed its concern that the resources of the Institute are stretched, and recommended that research and development be concentrated on the most advanced and unique projects and installations.

Nuclear Physics with Neutrons. The PAC heard the report on the proposal of the FLNP Scientific Programme in the Field of Nuclear Physics for the years 2003–2009 and appreciated that it would be concentrated on the studies of parity violation and the breaking of time-reversal invariance to be carried out at IREN. More details about the study of neutron–neutron scattering lengths, neutron–nucleus interactions and electromagnetic properties of the neutron were requested for future meetings.

The PAC appreciated that the preparations for the full dismantling of the IBR-30 reactor are progressing in line with the announced schedule. The PAC noted, however, that there had been further problems in the development of IREN and recommended that regular financing and continuous support of the JINR technical services be provided to complete this project as close as possible to the announced date.

The PAC heard the proposal on the creation of a subcritical assembly driven by a proton accelerator at an energy of 660 MeV and noted the importance of this Subcritical Assembly at Dubna (SAD) for the study of the urgent, modern-day problems of energy production and nuclear waste transmutation.

Heavy-Ion Physics The PAC heard the FLNR Scientific Programme for 2003–2009. It supported the continuation of the activities carried out by this Laboratory on the upgrade of the cyclotron complex, synthesis of exotic nuclei and the investigation of their nuclear and chemical properties, nuclear reaction studies with stable and radioactive beams, and applied research.

The PAC was impressed by the progress of the DRIBs project (Phase I) and believed that Phase II should also be realized quickly. The PAC approved the experimental programme presented for DRIBs and recommended high-priority support of all aspects of the DRIBs project and recommended also strong support of the MASHA project, which would allow direct mass determinations ($\Delta m/m \approx 0.1\%$) and more detailed studies of chemical and physical properties of superheavy elements.

The PAC noted the recent progress in the conception of SHE chemical investigations for elements $Z = 114$ and 112 and recommended that this activity be fully supported and carried out with high priority.

Low- and Intermediate-Energy Physics. The PAC learned the DLNP scientific research plan for the years 2003–2009. The PAC recognized the importance of investigations of rare weak processes aimed at searching for new physics beyond the Standard Model. The PAC supported these activities, in particular, projects such as NEMO-3 and TGV-2, which would search for double β decays, in particular, neutrinoless double β decay of various nuclei, and the ANCOR programme on the weak interaction in nuclear β decay and muon capture. The PAC encouraged DLNP's continued participation in the development of new-generation detectors such as MAJORANA in the field of neutrino physics. The theoretical support provided to these activities was also appreciated. Light-meson production in proton–nucleon collisions and the study of cumulative processes in proton–nucleus interactions (ANKE–COSY) also open long-term research prospects, as does the pion β -decay experiment.

The PAC received reports on the Phasotron operation in 2001 and noted progress on the two ongoing stages of its modernization. The PAC awaits the results of the Phase III study and also required a presentation of the physics motivation for Phase III and of the potential benefits for the existing Phasotron experiments.

Phasotron experiments on low-energy pion interactions (DUBTO), the search for an anomalous scalar particle in muon decay (FAMILON), muon-catalysed fusion (CATALYSIS), muon-capture studies (MUON) and nuclear-spectroscopy investigations using a mass separator (YASNAPP) will also extend into this period.

BLTP Research Programme. The PAC supported the development of the BLTP research programme on the theory of the nucleus presented for the years 2003–2009 and stressed the importance of theoretical research for the general activities of JINR. It especially appreciated the cooperation of this Laboratory with experimental and theoretical groups at JINR and abroad, as well as with the JINR University Centre, in training young scientists.

JINR Educational Programme. The PAC noted the guidelines of the JINR Educational Programme for 2003–2009. It supported this activity as a means to invest in students and young scientists who are essential for the continuing success of the JINR Scientific Programme.

Laboratory of Information Technologies. The PAC noted the report on LIT's proposal for the JINR Scientific Programme for the years 2003–2009. The proposal aims at meeting the JINR needs in the field of networking and computing infrastructure as well as at developing computer physics activities. The PAC heard with satisfaction that the situation with the local area networking and external communication links had notably improved. It recommended permanent effort with adequate financing towards upgrading, modernizing and improving reliability and security features of the networking and computing infrastructure. The PAC heard a proposal for a new theme «Information, Computer and Network Support of JINR Activities» and supported opening this new theme from 2003.

Radiation Therapy. The PAC heard the report on conformal proton-radiation therapy, in which the advantages of present proton therapy were clearly demonstrated. The PAC recommended the creation of an appropriate organizational structure for proton therapy demands from hospitals.

Scientific Reports. The PAC heard two scientific reports: «Extension of the Strutinsky Method» (by V. Pashkevich) and «The First Results Obtained by the Russian Detector of High-Energy Neutrons HEND on the NASA Spacecraft “2001 Mars Odyssey”, Perspectives of Cooperation» (by V. Shvetsov). It highly appreciated the new results presented in them.

The 18th meeting of the Programme Advisory Committee for Particle Physics was held on 11–12 November. It was chaired by Professor T. Hallman.

The Programme Advisory Committee for Particle Physics noted with interest the information presented by Vice-Director A. Sissakian on the recommendations of the 92nd session of the JINR Scientific Council (June 2002), and on the completion of the initial draft of «The Programme of the Scientific Research and Development of JINR for the Years 2003–2009». The PAC supported the timely and well-focused effort of the JINR Directorate to develop a sound and competitive scientific foundation for the medium- and long-term future of the Institute, and considered the present draft pro-

gramme a decisive step in establishing a basis for a final draft of the long-range programme.

The PAC noted that further work was needed to clearly define within the plan the long-term scientific future of the Institute, especially for the years after 2006, when the LHC operation will have started. The PAC also considers that a discussion in the long-range plan of the overall structure of JINR would be appropriate. Given the level of resources required for large particle physics programmes in the future, the PAC considers that a restructuring may be essential to eliminate duplication of effort and programmes and to make the Institute more focussed and efficient overall.

The PAC noted with interest the information on the proposals in the fields of particle physics and relativistic nuclear physics for 2003–2009, presented by VBLHE Director A. Malakhov, BLTP Director A. Filippov, LPP Director V. Kekelidze, DLNP Director N. Russakovich and LIT Director I. Puzynin. In general the scientific merit as well as the requested funding and manpower level need a thorough evaluation and justification for all projects included in the plan in terms of the main physics goals of JINR from 2003–2009. In addition, the PAC would also like to encourage discussion of the Institute's objectives beyond the year 2009. This is essential since several ongoing programmes finish or change their scientific scope in 2006/2007.

The PAC was gratified to learn of the prospective plan for the organization, maintenance, and development of the university-type education process at JINR, presented by UC Director S. Ivanova. The PAC fully supported this activity as a means to encourage and invest in young scientists and students who are essential for the success of the scientific programme in particle physics.

The PAC reviewed the proposals of new projects, presented at this meeting (PHENIX, Thermalization, TUS, BECQUEREL), and recommended their approval for execution with first priority until the end of 2005. Also two new themes were approved for execution with first priority until the end of 2007: «Information, Computer and Network Support of JINR Activities» and «Modern Mathematical Physics».

The PAC noted that the proponents of the MARUSYA project had presented a revised proposal, which took into account the remarks of the VBLHE Directorate and of the PAC at its previous meeting. The PAC recommended continuation of the project with first priority until the end of 2005.

The PAC took note of the report «Strategic Coordinated Plan for the Scientific and Technical Development of the Nuclotron Accelerator Complex for the Years 2003–2005». The PAC noted the significant achievements in the development of this facility over the last few years. It recommended extension of the theme «Development of the Nuclotron Accelerator Complex» with first priority until the end of 2003, and requested that a proper evaluation be undertaken of the scien-

tific potential of the Nuclotron by a special committee, which includes outside experts, within six months. This should provide the basis for priority setting for the development of the Nuclotron accelerator.

The PAC highly appreciated the report on the DELPHI experiment at LEP (CERN), which has demonstrated the benefits of a large-scale participation of JINR people in the detector construction and physics analysis. In more than ten years of successful DELPHI operation, many excellent results have been obtained. Taking into account future plans for several analyses of the data collected by DELPHI, the PAC recommended extension of JINR's participation in DELPHI with first priority until the end of 2005.

The PAC took note of the following reports:

- «Theoretical and Experimental Investigations of the Electronuclear Method of Energy Production and Radioactive Waste Transmutation» and recommended extension of this activity with first priority until the end of 2005;
- JINR's participation in the D0 experiment (FNAL). The PAC was pleased to note that the JINR group had made a valuable contribution to the upgrade of the D0 experiment by having produced the detectors and electronics for the forward muon tracker and that the JINR group has an interesting physics programme (in QCD and *b*-physics) as a contribution to the D0 experiment;
- JINR's participation in the CDF experiment (FNAL). The PAC was pleased to note that the JINR group had made a significant contribution to the CDF detector by providing new, unique detectors and trigger processors. This group has a long-term programme of forefront physics studies at Fermilab's Tevatron and has already started the data processing according to this programme. The PAC recommended continuation of JINR's involvement in the D0 and CDF projects with first priority until the end of 2005;
- JINR's participation in the STAR experiment (BNL). The PAC noted the significant contribution made by JINR to the construction and preparation for the coming commissioning of the central and forward parts of the STAR Electromagnetic Calorimeter. It highly appreciated the successful activity of the large group of JINR experts working in the USA as well as the efforts of JINR physicists in the EMC software development. The PAC recommended continuation of JINR's participation in this project with first priority until the end of 2005;
- JINR's participation in the HERA-B experiment (DESY). The PAC was pleased to note the significant progress in producing new experimental results at the HERA-B detector in accordance with its modified physics programme. The PAC recommended continuation of JINR's involve-

ment in this project with first priority until the end of 2005;

- JINR's participation in the NA49 experiment (CERN). The PAC recommended continuation of JINR's involvement in this activity with first priority until the end of 2005;
- DISK project. The PAC recommended continuation of this activity with first priority until the end of 2005, but expressed its concern that the slow progress of this experiment might be due to insufficient manpower as a consequence of time-sharing with other experiments;
- JINR's participation in the WASA experiment (Uppsala University). The PAC recommended continuation of this important activity with second priority until the end of 2005, provided dedicated financial support is given from non-budgetary sources;
- JINR's participation in the HARP, PS 214 experiment (CERN). The PAC was impressed by the fact that the large experimental facility was rapidly created during 17 months and that all data taking on the hadron production in the interactions of hadrons with a wide range of energies and different nuclei targets were completed in 2002. The PAC recommended continuation of this activity with first priority until the end of 2004;
- JINR's participation in the NOMAD experiment. The PAC recommended continuation of this activity with first priority until the end of 2003;
- NIS project. The PAC recommended continuation of this activity with first priority until the end of 2005 but noted that a strong effort should be made by the research team and the Directorate to speed up the commissioning phase of the project;
- PoLiD project. The PAC recommended continuation of this activity with second priority until the end of 2005, provided the Czech Republic gives dedicated financial support;
- upon proposal by the LPP Director, the PAC recommended continuation of the activity «R & D of Elements for Future Colliders» (JINR's participation in the LHC, TESLA, CLIC projects) for one year with first priority until the end of 2003;
- KAPPA project. The PAC recommended continuation of this activity with first priority until the end of 2003.

The PAC made a general remark concerning the preparation of proposals. It considers that the authors of projects should follow the «Rules of Proposal Preparation» carefully and provide a brief summary of their projects with all essential information available. The PAC also recommended that the procedure of treatment of the requests for extensions of ongoing experiments be included in these rules. These requests should be treated in much the same manner as new proposals. However, the written reports should concentrate

on the technical progress; physics results achieved so far; reasons why more time is needed to accomplish the original physics goals; additional physics goals if any; planned changes in the experimental set-up; additional resources required; in large international collaborations: Dubna members' achievements and impact.

The PAC noted with interest two informative reports presented at the meeting: «The Torino–Dubna Proposal to Construct Large Area Tracker RICH Wall for COMPASS» (by A. Maggiora) and «Dark Matter Search with Germanium Detectors» (by V. Bednyakov).

The 17th meeting of the Programme Advisory Committee for Nuclear Physics was held on 14–15 November. It was chaired by Professor N. Rowley.

The PAC was informed on the implementation of recommendations of the last meeting and on the Resolution of the 92nd session of the JINR Scientific Council (June 2002). The PAC reviewed the research programmes on nuclear physics of FLNR, FLNP, DLNP, BLTP and LIT as components of the general document «The Programme of the Scientific Research and Development of JINR for the Years 2003–2009» and recommended approval of their general lines.

Heavy-Ion Physics. In addition to the proposed experimental programme, the PAC feels that the exploitation of a gamma-ray multidetector would significantly add to the research activities, both in respect of the spectroscopy of very heavy nuclei and of possible projects involving radioactive beams. The PAC recommended that the MASHA mass separator project be realized with high priority. Modernization of the U400 cyclotron and preparation of experimental equipment is an essential prerequisite for the synthesis of superheavy nuclei and for effective work with radioactive-ion beams. The PAC recognized the notable achievement of FLNR in launching the first part of the DRIBs accelerator complex, i. e., production of a ${}^6\text{He}$ beam, and recommended that the necessary funds should be delivered on time. The PAC noted the encouraging results of the experiments on the synthesis of superheavy nuclei with $Z = 118$. It wished the Laboratory success in the continuation of this experiment.

Nuclear Physics with Neutrons. The PAC noted that the highest priority in this field of research is given to experiments aimed at investigations of fundamental symmetries and their possible violations, of neutron properties and of basic interactions with neutrons. The programme concerning high-resolution neutron sources includes investigations of the breaking of time-reversal invariance, studies of basic properties of neutron resonances, nuclear fission and electromagnetic properties of the neutron. Such experiments will be performed at IREN, at the IBR-2 reactor and at the facilities of other research centres.

The programme concerning high-intensity neutron sources includes experiments with ultracold neutrons and neutron optics at ILL (Grenoble) and PSI (Villi-

gen), in particular, neutron-gravity experiments, and an experiment on the neutron–neutron interaction at the JAGUAR reactor in Snezhinsk (Russia). The PAC is aware of the strong interest and importance of these experiments. The PAC confirmed the high quality of these experiments and noted that the timely completion of the IREN project, including modernization of experimental equipment and electronics, is important for a successful realization of this interesting programme. The PAC looks forward to future presentations on the first experiments to be carried out with IREN.

Low- and Intermediate-Energy Physics. The DLNP programme consists of experiments in the field of rare processes and those forbidden by the Standard Model, in neutrino and weak-interaction physics, in nuclear reaction mechanisms and nuclear structure, and of the development of new facilities. The programme encompasses a very wide range of physics objectives pursued both locally (e. g., at the Phasotron) and abroad with leading facilities on the world stage. The PAC recommended that this programme be reviewed as a whole to determine priorities. A general report on the status and efforts in nuclear double β decay was invited for the next meeting.

Proposals of New Projects. «Direct Comparison of Electron and Positron Electric Charges at LEPTA». The PAC had serious reservations concerning the presented project. It also felt that it was important to elaborate other possible fundamental-physics experiments with LEPTA.

«Measurement of the Neutrino Magnetic Moment at the Kalinin Reactor Using the GEMMA Spectrometer». The PAC heard the proposal of a joint team from JINR and ITEP (Moscow) for a new experiment whose aim is to measure the magnetic moment of the neutrino with a sensitivity of $3 \cdot 10^{-11} \mu_B$. Since the measurement promises new frontiers in this area of neutrino physics, the PAC recommended full consideration of the project at its next meeting.

«Proposal on the Creation of an Electronuclear Facility at the Phasotron for Investigations of Nuclear Waste Transmutation (SAD project)». The PAC heard the progress made in the design of a new beam channel at the DLNP Phasotron for tests of a subcritical assembly (SAD). The PAC considered this project to be an important step in research towards nuclear waste transmutation and recommended preparation of the full-scale project, with detailed technical and financial assessments, for its next meeting.

Bogoliubov Laboratory of Theoretical Physics. The PAC appreciated the help that this Laboratory gives to the JINR University Centre in training young scientists. As always, the PAC stressed the strong need for continuous theoretical support of the JINR experimental groups. At the same time, it stressed the need to supply BLTP with the computing power essential for the success of this Laboratory's activities.

Laboratory of Information Technologies. The PAC noted that the situation with JINR's computing and information infrastructure had notably improved. In the near future, special attention should be paid to the development of 1-Gb/s network, both internal and external. A further important task is network security. These activities should be provided with adequate and regular financial support.

JINR Educational Programme. The PAC expressed its continuing appreciation of the activities of the JINR Educational Programme in promoting science amongst young people and in fostering links between JINR Member States. The financing of these activities should be clarified in the final version of the Institute's Programme for 2003–2009.

Scientific Reports. The PAC heard two scientific reports «Mathematical Modeling of Physical Processes Initiated by Particles and Ions in Matter and Mathematical Experiments with Electronuclear Set-ups» (V. Barashenkov) and «Cluster Features in Reactions and Structure of Heavy Nuclei» (R. Jolos).

The 17th meeting of the Programme Advisory Committee for Condensed Matter Physics was held on 21–22 November. It was chaired by Professor H. Lauter.

JINR Chief Scientific Secretary V. Zhabitsky reported the recommendations and considerations of the JINR Scientific Council concerning condensed matter physics. In his presentation, he announced the nomination of Dr N. Popa (Romania) as Deputy Director of the Frank Laboratory of Neutron Physics and of Dr D. Nagy (Hungary) as member of the JINR Scientific Council. The discussions at the PAC meeting were focused on the following issues.

The IBR-2 Reactor. V. Ananiev (FLNP) reported about the status of the IBR-2 refurbishment. The PAC was very satisfied with the still improving reliability of the performance of the IBR-2 reactor and the progressing refurbishment programme containing both the reflector exchange and the full reactor refurbishment to happen between 2007 and 2009.

Once again the PAC appreciated the timely contributed Minatom financial support for the IBR-2 reactor refurbishment and expressed its concern about the delay of payment from the JINR budget. The PAC recommended that the shortfall in the general funding and in the time schedule should be fully recovered by the JINR Directorate if possible still in 2002. The PAC supported the plan to get new reactor personnel through the new educational programme for engineers attached to the Dubna Branch of MIREA. The PAC supported extension of the theme «Upgrade of the IBR-2 Complex» with first priority up to the end of 2007.

The Refrigerator Facility (RF) of IBR-2. The PAC took note of the information presented by V. Ananiev about conclusion of a contract with «Heliummash» on the technical project of the RF and on making its design

specifications. The PAC understood that with the restart of the IBR-2 in 2004 also a new RF (the modernized refrigerator of the KGU-500 type) would be available for cycles during which the existing cold source will run.

Cryogenic Moderator (BBS — Broad-Band Source) of IBR-2. The PAC took note of the report by E. Shabalin (FLNP) about the present solid methane moderator and about the plans and studies for a new solid moderator. The concept of the solid methane moderator developed at FLNP gives gain factors higher than at any other neutron facility with cold moderators. The PAC supported the plans to run the existing cold moderator between 2004 and 2007. It was also ready to discuss the proposals for optimization of the BBS dedicated for spectrometers.

Instrumentation. The PAC took note of the report by A. Kuklin (FLNP) about the upgrade of the YuMO small-angle spectrometer and of the report by V. Aksenov (FLNP), who announced that the modernization of the SPN-1 reflectometer had been successfully performed and that the upgraded reflectometer is called REMUR. The PAC congratulated A. Kuklin for his initiative to upgrade YuMO, in particular in view of his efforts for a new two-dimensional detector. The PAC congratulated also V. Aksenov and the scientific team of REMUR for the successful commissioning of the reflectometer.

JINR Scientific Programme in the Field of Condensed Matter Physics for 2003–2009.

The PAC took note of the excellent presentations of the proposals of the JINR Laboratories for the JINR Scientific Programme in the Field of Condensed Matter Physics for 2003–2009: by A. Belushkin for FLNP, E. Krasavin for DRRR, D. Blaschke for BLTP, and S. Dmitriev for FLNR.

The PAC noted that condensed matter studies at JINR are concentrated traditionally around physics with neutrons and other topics presented above by the Laboratories. However there are more CM activities at JINR like μ SR, activation analysis combined with life science, activities with EXAFS and 3-D tomography by confocal laser microscopy and activities «around X-rays», including also the DELSY project. The PAC considers a coordination of these activities as necessary and it should be presented in the seven-year plan. Further, a plan that envisages globally that Condensed Matter Physics could crystallize to a centre of excellence should become visible in the seven-year plan. This center of excellence could contain «Applied Physics» without stressing this name. JINR is worth making such a step, which, the PAC feels, is already triggered by the Ministry of Atomic Energy.

In his report, FLNP Director A. Belushkin described a timely and exciting scientific programme in the seven-year plan, also the difficulties on the instrumental side to perform such an ambitious programme. The performance of the IBR-2 reactor seems to be underestimated.

The reactor can be put in line with ILL or ISIS and is worldwide in front with the leading neutron sources. The improvement of the performance of the spectrometers due to neutron optical elements as neutron guides and focusing elements as well as following the progress in multidetector development is necessary, if the wish is present to obtain the world best results on the spectrometers.

DRRR header E. Krasavin presented the scientific programme in radiobiology including radiation genetics and photobiological process as contained in the seven-year plan. The PAC underlined the importance and actuality of this programme.

In his report, BLTP Deputy Director D. Blaschke described the new structure of BLTP and presented its activity with respect to Condensed Matter Physics with highlights of Bose–Einstein Condensation in traps and quantum dots and wires. The presented Programme is of top level and attractive with respect to Neutron Scattering as well as Condensed Matter Physics.

FLNR Deputy Director S. Dmitriev described artificially created new materials such as track-etched membranes and nanostructured surfaces, nanowires or nanocylinders to mention a few examples of this exciting new field of investigation. This is a very attractive area of research which was fully supported by the PAC.

Concluding Recommendation on the JINR Scientific Programme for 2003–2009. The PAC for Condensed Matter Physics took into account the presentations by A. Belushkin, E. Krasavin, S. Dmitriev, D. Blaschke concerning separate directions of the JINR scientific programme in the seven-year plan. The PAC fully approved the basic directions of this programme concerning research with neutrons at FLNP, radiobio-

logical research at DRRR, theoretical research in condensed matter at BLTP and materials science at FLNR. The PAC addressed to the JINR Directorate the request to present a uniform concept of the scientific programme of JINR in the field of condensed matter on the basis of the research performed at all Laboratories of JINR. The concept should contain most complete possible overview of the topic, envisaged and also to be developed activities in condensed matter.

Scientific Reports. V. Somenkov (RRC «Kurchatov Institute») presented an overview about «Neutron Investigation at High Pressure». Up-to-date topics with oxide superconductors, magnetic systems, GMR effect were studied, an area of investigation that could develop further if the corresponding neutron spectrometers were further optimized.

V. Osipov (BLTP) presented «Topological Defects in Microcrystals». His theoretical investigations of topological defects of fullerene and graphitic cones are still a challenge for neutron investigations. This contribution showed that coordination in this case between BLTP and FLNP is present.

S. Tiutiunnikov (LPP) presented «EXAFS Spectroscopy at the Siberia-2 Synchrotron-Radiation Source». In the presentation also a «Scanning Confocal Microscope» was mentioned, a device for complementary studies of neutron scattering. Only research centres can afford such a device.

The PAC took note of the information presented by V. Aksenov about the results of the Workshop on Investigations at IBR-2 (Dubna, 17–19 June 2002). The PAC strongly supported the annual repetition of this workshop and the opening to the international community.

PRIZES AND GRANTS

A group of authors – L. Patur, S. Peletminsky and V. Kadyshevsky — were presented **the Academician Bogoliubov 2001 Award**, founded by the National Academy of Sciences of Ukraine, for the series of papers under the title «Field Theory and Disordered Systems Theory». The authors were handed the Diplomas at the meeting of the National Academy of Sciences of the Ukraine on 5 April 2002.

By the Order of the President of the Russian Federation **the RF State Prize 2001 in Science and Technology** was conferred on a group of scientists among whom was Corresponding Member of the Russian Academy

of Sciences, Chief Engineer of the Joint Institute for Nuclear Research I. Meshkov, for the cycle of papers «Method of Electron Cooling of Heavy Charged Particle Beams».

The Pontecorvo Prize 2002 came to Professor S. M. Bilenki (JINR) for an outstanding contribution to theoretical studies in the field of neutrino oscillations.

The Bogoliubov 2001–2002 Prize was conferred on Academician A. Tavkhelidze (Georgia) and Professor J. Nambu (USA) for their fundamental contribution to the theory of colour quarks.

PRIZEWINNERS OF JINR'S ANNUAL COMPETITION FOR BEST RESEARCH — 2002

Theoretical Physics Research

First Prize

«Microscopic Description of Double Giant Resonances in Atomic Nuclei».

Authors: V. Voronov, V. Ponomarev.

Second Prize

«Nonlocal Condensates in QCD Vacuum and Meson Properties».

Authors: A. Bakulev, S. Mikhailov, A. Radyushkin.

Experimental Physics Research

First Prize

«Theoretical Prediction and Experimental Study of Quantum States of the Neutron in the Gravitational Field of the Earth».

Authors: V. Nesvizhevsky, H. Börner, A. Petukhov, A. Gagarsky, S. Baebler, H. Abele, A. Strelkov, V. Luschikov.

Second Prizes

«Development of Techniques for Studying the Structure and Dynamics of Condensed Matter by

Neutron Scattering under High Pressures at Pulsed Reactors».

Authors: V. Aksenov, A. Balagurov, D. Kozlenko, S. Platonov, B. Savenko, V. Glazkov, V. Somenkov.

«Experimental and Theoretical Study of Fusion–Fission Processes of Superheavy Nuclear Systems».

Authors: Y. Aritomo, V. Voskresenski, V. Zagrebaev, M. Itkis, G. Kniajeva, E. Kozulin, N. Kondratiev, L. Krupa, Yu. Oganessian, E. Prokhorova.

Physics Instruments and Methods

First Prize

«Slow Beam Extraction from the Nuclotron».

Authors: I. Issinsky, V. Karpinsky, H. Khodzhibagiy, A. Kovalenko, V. Mikhailov, V. Monchinsky, S. Novikov, V. Seleznev, B. Vasilishin, V. Volkov.

Second Prizes

«Design and Production of the ATLAS Hadron Tile Calorimeter Modules, Creation of the New Laser Control Method for their Assembly and their Performance Investigation Based on the Newly Developed Methods».

Authors: J. Budagov, Yu. Kulchitsky, Yu. Lomakin, M. Lyablin, M. Nessi, V. Romanov, N. Russakovich, A. Sissakian, N. Topilin, J. Khubua.

«Acceleration of ^6He Ion Beam at the U400 Cyclotron (Phase I of the DRIBs Project)».

Authors: Yu. Oganessian, G. Gulbekian, V. Bashevoy, S. Bogomolov, D. Bogdanov, B. Gikal, G. Ivanov, I. Kolesov, S. Paschenko, A. Tikhomirov.

Applied Physics Research

First Prize

«TRITON — the Installation for the Experimental Study of Muon Catalyzed Fusion Reactions at the JINR DLNP Phasotron».

Authors: N. Grafov, D. Demin, V. Zinov, A. Konin, A. Rudenko, V. Filchenkov, Yu. Vinogradov, S. Grischechkin, V. Perevozchikov, A. Yukhimchuk.

Second Prize

«Statistical Model of Network Traffic».

Authors: I. Antoniou, P. Akritas, V. Ivanov, V. Ivanov, Yu. Kalinovsky, V. Korenkov, Yu. Kryukov, P. Zrelov.

Encouraging Prize

«Research and Development of the Single Crystal Scintillation Time Spectrometry to Search for Short-Lived Nuclear States».

Authors: V. Kalinnikov, N. Lebedev, V. Morozov, N. Morozova, Yu. Norseev, I. Churin.

GRANTS

In 2002 a number of scientific projects at JINR were supported financially by the international foundations ISTC, INTAS, INTAS–RFBR, DFG, DFG–RFBR, CNRS, CNRS–RFBR, CRDF and foundation of the Ministry of Industry, Science and Technology of the Russian Federation.

The RF Ministry of Industry, Science and Technology, together with RFBR, financed four grants of the President of RF «Leading Scientific Schools». RFBR

financed 75 grants for the competition «Initiative Projects», 10 projects for the competition «Projects of Establishment and Development of Information, Computing and Telecommunication Resources», 1 project for the competition «Software for Supercomputers and Supercomputer Systems», 2 projects for the competition «Regional Competition 2001: the Moscow Region». Nine grants were obtained by JINR staff for the competition «Programme of Support for Young Scientists».

INTERNATIONAL RELATIONS AND SCIENTIFIC COLLABORATION



COLLABORATION IN SCIENCE AND TECHNOLOGY

The basic results of the international cooperation in science and technology of the Joint Institute for Nuclear Research in 2002 reflect in the following figures:

- joint research has been conducted with scientific centres in Member States as well as international and national organizations in other countries on 39 themes of first priority and 7 themes of second priority;
- to solve cooperation issues and questions of participation in scientific meetings and conferences, the Joint Institute sent 2836 specialists on official journeys;
- for joint work and consultations as well as for participation in meetings, conferences and schools held at JINR, 1364 specialists were received;
- 20 international scientific conferences, 14 workshops and 12 organizing meetings were organized and held;
- 24 scholarship holders worked at JINR Laboratories.

The international cooperation of JINR is presented in agreements and treaties. It comprises joint experiments at basic facilities of physics centres, the acquisition of research data, preparation of publications of the joint research results, the supply of equipment and techniques for the interested sides, etc.

JINR leaders and laboratory directors had a meeting with the delegation from Belarus on the eve of the 91st session of the JINR Scientific Council, in whose framework the round-table discussion «Belarus at JINR» was held.

During the meeting the sides exchanged their opinions on the development of cooperation between scientific centres, universities and enterprises of Belarus and JINR. Leading scientists of this republic were presented the honorary diplomas of the Joint Institute for Nuclear Research for their remarkable contribution to the cooperation between JINR and scientific and educational centres of Belarus and in connection with the 30th anniversary of the Gomel school.

On 19 January, member of the JINR Scientific Council, CERN Director of Research C. Détraz inspected the work on the COMPASS and ATLAS experiments. He visited a new site at the Laboratory of Particle Physics for production of straw-tube detectors. C. Détraz had talks with JINR Vice-Director A. Sissakian and LPP Director V. Kekelidze on various aspects of cooperation.

On 29 January a delegation from Greece visited the Joint Institute for Nuclear Research. It included General Secretary on Research and Technology of the Ministry of Development of Greece D. Deniozos, Chief of the Department of the General Secretariat on Research and Technology V. Messaneos, the Department staff member G. Bonas, Trade Attaché of the Embassy of Greece in the Russian Federation A. Makrandreu, Member of the JINR Scientific Council Professor N. Giokaris.

JINR Director Academician V. Kadyshevsky, JINR Vice-Directors Professors A. Sissakian and Ts. Vylov, members of the JINR Directorate and Laboratories' directors received the delegation. The JINR Director informed the Greek guests about main trends of fundamental and applied research conducted at JINR; in particular, he spoke about joint work of scientists from JINR and Greece in developing detectors for LHC at CERN. The Greek delegation visited the Flerov Laboratory of Nuclear Reactions. The sides exchanged opinions on a wide list of cooperation issues, which covers today many topics in the research programme of JINR. The intention to continue activities aimed at joining JINR by Greece as an Associate Member was confirmed.

JINR Director V. Kadyshevsky and JINR Vice-Director A. Sissakian stayed in the USA on a working visit. The purpose of the visit was a discussion of cooperation of JINR with scientific centres and universities of the USA and preparation of an Agreement on the JINR–USA cooperation on the governmental level.

From 30 January to 2 February the JINR leaders visited the National Fermi Laboratory (Batavia, Chicago). They had talks with the Laboratory Director Professor M. Witherell, Deputy Director Professor K. Stanfield, Assistant to Director on international scientific-technical cooperation R. Rubinstein, CDF and D0 collaboration leaders F. Bedeski, D. Beletinni, D. Wormspay, H. Wirtz and other leading scientists. The American colleagues marked an important contribution of JINR scientists to the development of the CDF (JINR coordinator J. Budagov) and D0 (JINR coordinator G. Alekseev) facilities in the realization of the research programme. An agreement (MoU) on JINR participation in the CDF experiment was signed, which marked that specialists from JINR Member States and Greece would take part in the experiment via Dubna. JINR specialists Yu. Yatsunenkov, G. Alekseev, N. Skachkov, A. Semenov and others took part in the discussions.

On 3 February the JINR delegation met with the President of Education Center in New York J. Tokhadze and discussed cooperation issues in educational programmes of JINR and Dubna University.

On 4 and 5 February V. Kadyshchevsky and A. Sissakian visited the Brookhaven National Laboratory and had meetings with its Director Professor P. Paul and his Deputy Professor T. Kirk, department leaders D. Lovenstein, H. Gordon, T. Hallman, S. Aronson, S. Ozaki, M. Miller and other scientists. A Protocol to the Agreement on cooperation was signed. In this document, together with examples of joint work, support in relation to the associate membership of the USA at JINR was expressed by BNL leaders. It was recommended to conclude a JINR-DOE (Department of Energy, USA) Agreement.

At the meeting, Diplomas were handed: a Diploma of JINR Honorary Doctor to Professor S. Ozaki and Diplomas of Dubna University Doctors to Professors P. Paul and T. Hallman. JINR coordinator on STAR project collaboration Doctor Yu. Panebrattsev took part in the meeting.

On 6-7 February the delegation was in Washington, where they had meetings and discussions with leading organizers of American science. The JINR leaders met with Acting Director on international affairs of the American National Academies of Sciences Doctor G. Boright, US President Adviser on Science and Technology, Director of the Department of Science and Technology Policy of the US Administration Professor J. Marburger, Adviser to the US State Secretary on science and technology Doctor N. Newriter, Deputy Director of the National Science Fund (NSF) on physics and mathematics Doctor R. Isenstein, Director on high energy physics and nuclear physics of the science division of the Department of Energy Doctor P. Rosen, Director on international scientific-technical cooperation of the science division of DOE Doctor H. Gaffe. President of American University in Russia and «Russian House»

in the USA Doctor E. Lozanski also took part in the meetings.

The cooperation between JINR and scientific centres and universities of the USA was highly estimated and it was considered expedient to work out an agreement on cooperation between the Department of Energy (DOE) of the USA and JINR in science and technology. It is obvious that the Agreement will establish a new level of relations between the USA and JINR.

On 8-10 February V. Kadyshchevsky and A. Sissakian visited Florida State University (Tallahassee). They had meetings with Director of the National High Magnetic Field Laboratory Professor G. Crow, Director of the Institute of International Cooperation in Environmental Protection Research Professor R. Herndon, Vice-Director of the Institute Professor M. Khankhasaev, Professor M. Davidson, Professor V. Hagopyan and other scientists. V. Kadyshchevsky and A. Sissakian made reports at a seminar in Florida University about the JINR scientific programme and JINR cooperation with the USA scientific centres and universities.

From 4 to 10 February Director of JINR's Laboratory of High Energies Professor A. Malakhov stayed at GSI (Darmstadt) with an official visit. For a long time the Laboratory physicists have been successfully cooperating with their colleagues from this institute in a number of fields. A collaboration of 18 institutes created at GSI a dilepton spectrometer of high resolution HADES for experiments with heavy ion beams. For these experiments, multilayer drift chambers with a small amount of matter and high space resolution have been developed at LHE, JINR. The first physical run at HADES was conducted in November, 2001. The acquired data are being processed.

In collaboration with Heidelberg University and GSI (Darmstadt), LHE has started to develop the large detector of transitional radiation for the ALICE project at the new CERN accelerator, which is under construction now. Professor A. Malakhov discussed the main questions of an agreement on this joint work with the GSI directorate and the project coordinator from the university. Due to the development of a new accelerator of heavy ions and antiprotons at GSI, in collaboration with LHE, research has been conducted in the design of fast cycling superconducting magnets. Professor Yu. Zanevsky, Coordinator of the LHE participation in the HADES project and in the construction of the transitional radiation detector, took part in the discussions.

The Joint BMBF-JINR Steering Committee held its 12th meeting on 25-26 February. JINR Director V. Kadyshchevsky and JINR Vice-Director A. Sissakian made reports on the activities at JINR in 2001 and research programme for 2002. JINR Assistant Director for Economic and Financial Issues V. Katrasev spoke on the implementation of the JINR budget and the ap-

plication of German contribution in 2001. The participants of the meeting discussed current joint projects and prospects of cooperation between German and JINR scientists. Other questions of the discussion were the amount of the German contribution for 2002 and its application, a list of projects in theoretical physics, neutron physics, heavy ion physics and high energy physics which are planned to be financed by the German side.

JINR Vice-Director Professor A. Sissakian stayed at CERN with a working visit from 28 February to 2 March and on 10–12 March. He met with CERN Director for Research, Co-Chairman of the Joint Committee on CERN–JINR cooperation Professor R. Cashmore and Coordinator of CERN cooperation with Russian scientific centres N. Koulberg. Collaboration in the ATLAS, ALICE, CMS and COMPASS experiments was discussed together with questions of organization of joint exhibitions «Science Bringing Nations Together» and other issues. On 11 March, on behalf of the JINR Directorate, A. Sissakian ceremoniously handed Honorary Diplomas and presents to the long acting Co-Chairman of the Joint Committee on CERN–JINR cooperation Professor D. Allabi and Chief Editor of the journal «CERN Courier» G. Fraser. The awards were conferred on these CERN staff members, on their recent retirement, for the eminent contribution to the development of cooperation with JINR.

JINR Director Academician V. Kadyshevsky, JINR Assistant Director for International Relations Professor P. Bogolyubov and JINR Scientific Council Member Professor M. Mateev (Bulgaria) took part in the scientific conference dedicated to the 40th anniversary of the Physics Centre of Latin America (PCLA) in Rio de Janeiro, where they made reports. According to the agreement between JINR and PCLA, three scholarship holders from Latin American countries are working at JINR at the moment. The JINR representatives at the conference had negotiations with their colleagues from CERN and Spain and met with Cuban scientists who used to work at JINR once.

On 27 March the Joint Institute for Nuclear Research was visited by a Czech delegation which included the deputies of the Czech Parliament Vice-Chairman of the Committee on Science, Education, Culture, Youth Affairs and Sport P. Pleva, Committee members J. Maniasek, A. Rozegnal, Czechian Embassy Adviser B. Krh, the Parliament administration staff members M. Gavdrova, A. Muhova and the accompanying staff.

At the JINR Directorate, JINR Vice-Director A. Sissakian, members of the Institute Directorate, of the Directorates of the Flerov Laboratory of Nuclear Reactions and the Veksler and Baldin Laboratory of High Energies and Czech scientists working at JINR received the delegation. The guests were acquainted with the In-

stitute history and main fields of research, as well as the wide international cooperation, including scientific centres and universities in Czechia. The guests visited JINR Laboratories, met with Czech scientists working in Dubna and students from Czech universities who are practicing at JINR Laboratories and JINR University Centre.

On 2–6 April a delegation from JINR Directorate visited Czechia and Slovakia. It included JINR Vice-Director Ts. Vylov, VBLHE Director A. Malakhov, FLNR Director M. Itkis, FLNR Deputy Director J. Kliman. The aim of the visit was to discuss JINR joint research projects with the national scientific centres of Czechia and Slovakia in the framework of the JINR scientific and technical plan for 2002. Joint expert boards (3+3) took decisions, which were relatively documented as protocols.

JINR Director Academician V. Kadyshevsky and Vice-Director Professor A. Sissakian visited Czechia on 7–10 April. They had meetings and negotiations during the visit with Deputy Minister for Industry and Trade of the Czech Republic F. Kubelka, Director of the Department of Nuclear Energy of this Ministry F. Suranski, General Director of Czech Ministry of Foreign Affairs (responsible for international multilateral contacts) J. Przivratski, Rector of Carl University Professor I. Vilhelm, President of the AS Council on International Ties I. Niderle, Plenipotentiary of the Czech Government to JINR Professor R. Mach and other scientists and leaders.

V. Kadyshevsky and A. Sissakian visited the Institute of Nuclear Physics in Rez, where they saw the set-ups, met with theorists, talked to Director Professor J. Dobes and Scientific Secretary J. Ditrih. They also had a meeting with Director of the company «Vacuum-Prague» P. Hedbavny.

On 11–12 April CERN Research Director Professor R. Cashmore and Director Assistant N. Koulberg visited Dubna. The guests visited the Laboratory of Particle Physics and the Dzhelepov Laboratory of Nuclear Problems, where they were acquainted with the current joint activities in the experiments ATLAS, CMS, ALICE and COMPASS. They also visited the CABMO enterprise (Kimry), where the magnet for the ALICE project is being manufactured. The guests took part in the discussion of cooperation issues with Dubna at the JINR Directorate.

On 22 April Vice-Chairman of the Vietnamese Atomic Energy Board (AEB) Bui Van Tuan and Director of the AEB department of international ties and planning Tchan Kim Hung visited JINR. They had a talk with JINR Scientific Secretary V. Zhbitsky and discussed questions of the developing cooperation between Vietnamese scientists and their colleagues from

Dubna. They also exchanged their opinions on a possible training programme for scientists and engineers at JINR in connection with the plans to build a nuclear power station in Vietnam.

On 22–24 April JINR Vice-Director Professor A. Sissakian represented the Joint Institute for Nuclear Research at the meetings of the CERN Review Resource Board devoted to the experiments at the LHC accelerator complex. CERN Research Director Professor R. Cashmore was the chairman of the meetings. CERN Director-General Professor L. Maiani spoke on the status of the accelerator construction and preparation of experiments at LHC. The Board discussed the drafts of the Memorandums of Mutual Understanding, which were prepared to be signed with CERN partners in all LHC collaborations.

A. Sissakian had meetings with CERN Director-General L. Maiani and other leaders of CERN and collaborations. Plans for further JINR participation in detectors' development and experiments at them were the topics of his discussions with Professor P. Jenni (ATLAS) and Professor M. Della Negra (CMS).

On 23 April a representative delegation from the US Department of Energy (DOE), headed by Deputy Minister R. Card, visited the Joint Institute for Nuclear Research. They had a talk at the JINR Directorate, where JINR Director V. Kadyshevsky informed the guests about JINR activities and the development of cooperation with scientific centres in the USA. The delegation visited the following JINR Laboratories: DLNP, FLNP and VBLHE. A presentation of a BNL–JINR educational project was held at the Veksler and Baldin Laboratory of High Energies.

The visit concluded in signing a joint Declaration of Intent between US Department of Energy and the Joint Institute for Nuclear Research, wherein the sides expressed their mutual interest in strengthening the cooperation in the fields of particle physics and nuclear physics. The document states that the new stage in the development of the scientific and technical cooperation reflects the new political, economic and social reality. Taking into account long-standing and successful cooperation in multiple experimental and other scientific projects in particle physics and nuclear physics between JINR and scientific centres and universities of the USA, the sides declared their intention to develop the joint activities in the above-mentioned fields, using experimental facilities and research laboratories of DOE and JINR.

From 27 April till 1 May the Joint Institute for Nuclear Research received a delegation of Bulgarian scientists, headed by Deputy Minister for Education and Science of the Republic of Bulgaria I. Damyanov.

Today Bulgaria is one of the most active Member States of JINR, both in the number of joint projects and the amount of scientific and technical ties. The cooper-

ation is being carried out in 29 topics with 9 Bulgarian scientific centres and 4 universities. At present, 20 scientists and 14 specialists from Bulgaria are working at JINR. Scientific meetings of JINR have been held in Bulgaria for several years.

I. Damyanov marked at the meeting with JINR Director V. Kadyshevsky that Bulgaria considers the cooperation with JINR very important, especially in the field of education of young people, who will develop scientific research in the country in future. Other important topics are, in his opinion, information technologies and applied science, application of fundamental knowledge in life, especially in medicine. The representatives of Bulgarian science met with JINR leaders, discussed issues of current and perspective cooperation. The guests visited the Institute's Laboratories, and were acquainted with the present facilities and those under construction.

On 7 May Ambassador of India to the Russian Federation Krishnan Raghunath and the Embassy Adviser on Science and Technology Hari Mohan Saksena visited the Joint Institute for Nuclear Research. JINR Director V. Kadyshevsky, JINR Vice-Director A. Sissakian, Chief Scientific Secretary V. Zhabitsky and Assistant Director P. Bogolyubov received the guests.

Speaking about the main activities of the Joint Institute, V. Kadyshevsky made a special remark on the cooperation of scientists of Dubna and India. Ten Indian scientific centres and universities are conducting joint research with JINR. Seven joint projects in different fields of theoretical and computational physics, particle physics and relativistic nuclear physics are being realized. During the visits of JINR representatives to India a possibility for this country to participate in JINR activities as an associate member was discussed.

Mr K. Raghunath marked that the Indian side had every intention to widen cooperation and increase the number of joint projects. He drew special attention to the educational aspects of the cooperation. The guests visited the Flerov Laboratory of Nuclear Reactions.

A meeting between Deputy Minister V. Fridlyanov and JINR Vice-Director A. Sissakian took place at the RF Ministry of Industry, Science and Technology on 29 May. The questions of the 2003 JINR budget and the perspective plan of JINR development, together with other items, were discussed. Deputy Head of the department of complex planning A. Volodin, Deputy Head of the department of basic and research activities V. Drozhenko, Head of the department of economic planning of JINR A. Ruzaev took part in the discussion.

On 3 June Director of the US Office of Science and Technology Policy Professor John Marburger visited JINR. The main purpose of J. Marburger's visit to Dubna was to become acquainted with the Joint Institute

for Nuclear Research and discuss questions of JINR cooperation with scientific centres and universities of the USA.

On the initiative of the leading American physicists, activities are under way to work out the text of a full-scale agreement between the US Department of Energy and JINR about the USA's associate membership to the Joint Institute. The visit of the Science Adviser to the US President to Dubna, accompanied by staff members of the Embassy of the United States in Russia, was one of the steps in this work.

Academician V. Kadyshevsky acquainted the guests with the Institute's status and history, and spoke about the main trends of research. He covered with more detail the cooperation of American and Dubna scientists. First Deputy of the RF Minister for Industry, Science and Technology Academician M. Kirpichnikov and other staff members of the Ministry, representatives of the RF Ministry of Atomic Energy, Professor A. Sissakian and other members of the JINR Directorate took part in the talks. Professor J. Marburger and the accompanying staff visited JINR's Flerov Laboratory of Nuclear Reactions and Frank Laboratory of Neutron Physics. Head of a VBLHE department Yu. Panebrattsev showed the guests a computer course of lectures on physics worked out by specialists of JINR and BNL.

Director of the Dzhelepov Laboratory of Nuclear Problems Professor N. Russakovich visited Belarus to discuss questions of the development of the international scientific and technical cooperation with leaders, research organizers and leading scientists of this country, which is a JINR Member State.

On 5 June Professor N. Russakovich and JINR Scientific Council member, Director of the National Research Centre of particle physics and high energies N. Shumeiko had a meeting with President of Belarus V. Lukashenko at the exhibition dedicated to the achievements of Belarussian scientists, opened at the Joint Institute of Energy and Nuclear Problems (academician scientific technical complex «Sosny»). In a brief talk, they gave the President an invitation from the JINR Directorate to visit the Joint Institute for Nuclear Research and marked positive aspects of cooperation of Belarussian scientific centres and universities with JINR. In his response, V. Lukashenko expressed an intention to visit JINR with a large delegation of Belarussian scientists. Different aspects of cooperation were discussed during the meeting. In particular, it was the joint work with the physicists from «Sosny» in atomic nucleus theory and theory of nuclear interactions to study physics sides of the electric nuclear method of energy acquisition along with other questions. The President of the Republic of Belarus highly estimated the prospects of the cooperation development, paying special attention to the use of accelerators for the treatment of oncological patients.

This topic was also discussed at the Oncological Research Centre of the Republic of Belarus in Borovlyany during the meeting of N. Russakovich with acting Public Health Minister of Belarus L. Postoyalko, who invited the DLNP Director to speak about ray therapy with the JINR Phasotron beams.

During the visit Professor N. Russakovich met with leading scientists of the RB National Academy of Sciences, with its President M. Myasnikovich and Plenipotentiary of the Government of Belarus to JINR, Vice-President of RB NAS A. Lesnikovich and discussed questions of participation of Belarus in the JINR activities.

An Agreement between the National Institute for Nuclear Physics (INFN) of Italy and the Joint Institute for Nuclear Research on scientific and technical cooperation was signed on 6 June. INFN President E. Iarocci and JINR Director V. Kadyshevsky signed the Agreement. The Agreement marked the long-standing and successful cooperation between INFN and JINR in different experiments and studies carried out according to previous agreements between the sides and the desire to influence further joint activities and cooperation in the sphere of application of experimental equipment of INFN and JINR to realize joint projects.

On 10–13 June JINR Director Academician V. Kadyshevsky and JINR Vice-Director Professor A. Sissakian visited Bucharest. On 11 June they were invited to the reception at the Embassy of the Russian Federation in Romania on the occasion of the national holiday — the Independence Day of Romania. At the Embassy V. Kadyshevsky and A. Sissakian had a meeting with President of Romania Ilion Iliescu, who had been informed about positive development of the relations between JINR and Romania as a JINR Member State and about the joint JINR–CERN exhibition in Bucharest «Science Bringing Nations Together». The President of Romania was invited to visit Dubna and accepted the invitation with gratitude.

During the visit V. Kadyshevsky and A. Sissakian met with the Romanian Parliament deputy M. Ignat, who, together with other deputies, had proposed that JINR and CERN be nominated for the Nobel 2002 Peace Prize, State Secretary of the Ministry of Education and Science A. Campurean, Plenipotentiary of the Government of Romania to JINR D. Popescu, Director-General of the Institute of Nuclear Electronics E. Dragulescu, Scientific Director of the Hulubei Institute F. Buzatu, General Director of the National Institute of Informatics Professor D. Banchiu, General Director of the Institute of Engineering Electronics Professor V. Cappel, General Director of the Institute of Theoretical and Experimental Aeronautics Professor A. Ionita and others. V. Kadyshevsky, A. Sissakian and CERN Research Director R. Cashmore took part in the press-conference at the Ministry of Education and Science on

the occasion of the exhibition opening and visited scientific centres. A meeting with young researchers from various Romanian institutes and Bucharest University was held at the Institute of Engineering Electronics. The young researchers had prepared projects for cooperation with JINR.

On 11 June the JINR–CERN exhibition «Science Bringing Nations Together» was ceremonially opened at the Ministry of Education and Science. A. Campurean, V. Kadyshevsky, R. Cashmore and other officials spoke at the opening.

On 27 June a delegation of Chinese scientists visited JINR. The visit was related to the big forum dedicated to the anniversary of the Agreement on friendship, friendly neighbour relations and cooperation between the Russian Federation and the Chinese People's Republic. In Dubna the Chinese scientists met with JINR leaders, visited the Bogoliubov Laboratory of Theoretical Physics and the Flerov Laboratory of Nuclear Reactions. During the reception at the JINR Directorate, JINR Director Academician V. Kadyshevsky introduced the directors of JINR Laboratories to the guests, spoke about the history of JINR and the main fields of research. The leader of the Chinese delegation Academician Chou Guanchao, who worked once at JINR, expressed his gratitude to the Institute Directorate for the invitation to recommence the cooperation. Academician V. Kadyshevsky suggested that Chinese experts should be recommended to take part in the JINR Scientific Council, which includes leading scientists from different countries of the world. Chou Guanchao invited V. Kadyshevsky to the annual meeting of the Scientific Council of the Chinese Academy of Sciences, held under the auspices of the All-Chinese Federation on Science and Technology.

On 3 July in Geneva at the European Centre of Nuclear Research (CERN) an unusual ceremony took place — «The Presentation of Module 65». The arrival at CERN of this 20-ton, 6-meter «hero» marked the successful accomplishment by the Joint Institute for Nuclear Research of an important international task to construct 65 modules for the calorimeter of the new facility ATLAS.

A large international community of scientists, engineers and workers from JINR's and CERN's member states took part in the work, i. e., from Belarus, Czechia, Georgia, Italy, Romania, Russia, Slovakia. Their efforts brought a facility compiled of 65 modules — the base of the superprecision physical device — a «hadron calorimeter». The leaders of ATLAS highly estimated the successful implementation of JINR's work.

A representative delegation of the Joint Institute for Nuclear Research, including the Institute Director V. Kadyshevsky, Vice-Director Ts. Vylov, Director of the Frank Laboratory of Neutron Physics A. Belushkin

and Assistant Director P. Bogolyubov, visited scientific centres in France. The aim of the visit was to participate in the presentation of the experimental NEMO-3 set-up in the Modane underground laboratory (LMS) and to see two international scientific centres in Grenoble — the Laue-Paul Langevin Institute (ILL) and the European Centre of Synchrotron Research (ESFR). The presentation of NEMO-3 was held on 12 July 2002. In April the physical start of the set-up was committed. The NEMO-3 track detector is developed in the framework of the international cooperation of France–JINR–Russia–USA–Ukraine–Czechia–Finland. The presentation was attended by directors of all leading French institutes and by delegations from Japan, the USA, Italy, Czechia and other countries.

The JINR delegation visited the Laue-Paul Langevin Institute, which is today the most advanced international centre of neutron research in the world, and the Synchrotron Centre in Grenoble, where the brightest source of the synchrotron radiation is used. The Institute leaders managed to become acquainted with the activities of the leading international centres in the fields of three scientific directions developed at JINR, i. e., nonaccelerator physics, neutron nuclear physics and condensed matter physics. A major contribution made by JINR to the realization of joint projects and the high professional level of research were pointed out in talks with the Centre leaders and in the public presentations of leading researchers. The necessity to further develop scientific cooperation and search for new ways of increasing its efficiency was stressed.

On 6 and 7 August a delegation from CERN visited JINR: Research Director Professor R. Cashmore, CMS project leader Professor M. Della Negra and Assistant Director N. Koulberg.

JINR Director Academician V. Kadyshevsky and Vice-Director Professor A. Sissakian received the guests on 6 August. The next day a meeting of the Joint Committee on CERN–JINR cooperation was held, where R. Cashmore and A. Sissakian were co-chairmen. Laboratories' Directors N. Russakovich and V. Kekelidze, LPP Deputy Director I. Golutvin, Assistant Director P. Bogolyubov took part in the meeting. CERN was represented by M. Della Negra and N. Koulberg. Both sides discussed the status of joint efforts at LHC.

The guests visited the JINR Laboratories. In particular, they were demonstrated the process of assembly of muon chambers at the Laboratory of Particle Physics and tests of first samples. The CERN representatives inspected an additional line, which is used for the CMS construction, then they studied the work on ATLAS. JINR is responsible for a large part of the track detector; almost all elements are ready for it now. The CERN delegation also visited the Dzhelepov Laboratory of Nuclear Problems, where work on ATLAS is being done.

The guests marked the large contribution made by Dubna to the development of the experimental base of three (ATLAS, CMS, ALICE) out of four projects to be implemented at LHC. The work is accomplished in time and at high quality. JINR accumulates efforts of many countries interested in the participation in these projects through Dubna.

On 8 August Director of the Department of Science and Technology of the Moscow Representatives of the Joint Russian–Taiwanese Board Dr H. Huang (Taiwan) visited JINR. The visit was held on his request. Dr H. Huang was received by JINR Vice-Director Professor A. Sissakian. Aspects of cooperation were discussed. The guest visited VBLHE and DLNP.

On 3 September Extraordinary and Plenipotentiary of Armenia in Russia A. Smbatian visited JINR. He was accompanied by an assistant G. Sayadian, chief of the protocol department A. Karapetian and representatives of mass media of Armenia. On the JINR side were present JINR Director V. Kadyshevsky, JINR Vice-Directors A. Sissakian and Ts. Vylov, Chief Scientific Secretary V. Zhabitsky, Chief Engineer I. Meshkov, Director of the Flerov Laboratory of Nuclear Reactions M. Itkis and Scientific Leader of the Laboratory Yu. Oganessian.

JINR Director Academician V. Kadyshevsky talked to the guests about the international status and contacts of JINR with other countries, about JINR's structure and most important research. JINR Vice-Director A. Sissakian introduced Armenia as a Member State which is traditionally involved in physics research. Today the main JINR's partners in Armenia are Yerevan State University, the Yerevan Institute of Physics, the Yerevan Scientific Research Institute of Optics Measurements and a number of industrial enterprises. The delegation visited the Flerov Laboratory of Nuclear Reactions and met with scientists and specialists from Armenia working at JINR.

On 4 September a meeting on the support of the project «Synthesis of Element 118» under the chairmanship of First Deputy Minister Academician M. Kirpichnikov was held at the Ministry of Industry, Science and Technology. JINR was represented by Vice-Director Professor A. Sissakian, FLNR Director Professor M. Itkis, and the Ministry was represented by Chief of Department A. Shcherbak, Deputy Chief of Department V. Drozhenko. Chief of Department Yu. Popov represented the Ministry of Atomic Energy. Concrete agreements were reached on the collaboration among JINR, SRIAR (Dimitrovgrad), SRIEP (Sarov) and possible foreign scientific centres.

On 4–10 September JINR Director V. Kadyshevsky, FLNP Director A. Belushkin and FLNR Deputy Director S. Dmitriev visited China. The JINR delegation was

invited to the annual conference of the All-Chinese Federation on Science and Technology, which was held on 5–8 September in Chendu. The conference was attended by more than 4500 scientists, who represented organizations from different ministries of China. On 7 September Academician V. Kadyshevsky made a report «JINR is Open to Cooperation» at the plenary meeting. About a thousand young scientists were specially invited to this part of the meeting. Detailed discussions with outstanding Chinese scientists on the problems of the development of the mutually beneficial cooperation and restoration of former ties were held. The JINR representatives visited the Institute of Nuclear Physics and Chemistry of the Chinese Academy of Sciences in Menyang. FLNP Director A. Belushkin had a talk with the Institute Director-General Professor Liu Hangang, the Institute Vice-Director and staff members of the laboratory of neutron research. A Memorandum was concluded to develop the cooperation between the Institute and JINR, where directions of joint activities were pointed out. The guests from JINR made a number of reports for the Institute staff members about the JINR scientific programme.

The scientists of JINR were invited to the Institute of High Energy Physics in Peking, where they had a meeting with the Institute Director Academician Heshen Chen and former Institute Director, President of the Chinese Accelerator Society Academician Phan Shousyan. Prospects of JINR–IHEP relations were discussed, including the question of the return of China to JINR. The JINR delegation met with Minister for Science and Technology of China Sui Guanghua, who expressed his opinion about good prospects of restoring and developing former ties. Ambassador of Russia to China I. Rogachev also received the guests and marked that the restoration of the Chinese membership at JINR is dictated by time and corresponds to the spirit of the Agreement signed by the Presidents of Russia and China in 2001.

At the invitation of JINR Director Academician V. Kadyshevsky, guests from Novy-Sazc (Poland) visited JINR on 5–6 September. These were Rector of the State Higher School of Professional Education Professor A. Balanda, who once worked at JINR, Vice-Mayor of Novy-Sazc P. Pawnik and Deputy Rector Z. Zaclona. The guests were received by JINR Vice-Director Professor Ts. Vylov and First Deputy Mayor of Dubna S. Dzyuba.

The Polish delegation visited the Veksler and Baldin Laboratory of High Energies, where they were acquainted with the activities of the group headed by Professor Yu. Zanevsky on the HADES project. Professor A. Balanda takes part in this project as member of the group from Cracow University. The guests visited the Flerov Laboratory of Nuclear Reactions and acquainted themselves with the scientific programmes and facilities of the Laboratory.

From 11 to 13 September JINR Director Academician V. Kadyshesky and Assistant Director for Economic and Financial Issues V. Katrasev visited Moldova.

Moldova has been a JINR Member State since 1992. The scientists from this Republic cooperate with JINR successfully and take part in large international projects in nuclear physics. Big partners are the Institute of Applied Physics of the Moldovan Academy of Sciences, Chisinau State University and Technical University. V. Kadyshesky held a seminar at the Institute of Applied Physics, where he spoke about the latest scientific results and the contribution of the Moldovan scientists to them.

The JINR delegation had negotiations with President of the Academy of Sciences of Moldova Academician A. Andriesh and Chairman of the Higher Council on Science and Technological Development of Moldova (HCSTD) A. Rotaru. In the exchange of opinions the sides confirmed mutual interests in further scientific and technical cooperation in theoretical physics and information techniques, together with applied research important to the economy of Moldova. The JINR delegation met with the leaders of the Moldovan Academy of Sciences, of HCSTD, First Deputy of the Moldovan Prime-Minister V. Iov and discussed the question of widening Moldova–JINR cooperation. Deputy Minister of Economy V. Afanasiev and Chief of the Government Administration Department I. Pasechnik took part in the discussions.

A delegation of scientists from India visited JINR on 27 September. It was headed by Dr D. Bhavalkar, the Director of the Advanced Technology Centre of the Atomic Energy Department. He was accompanied by Dr P. Satiamurti and Dr V. Sahni (H. Bhabha Atomic Research Centre, Mumbai) and other official people. The delegation visited FLNP, FLNR, VBLHE and met with the Institute leaders. JINR was represented by JINR Director V. Kadyshesky, JINR Vice-Director A. Sissakian, Chief Scientific Secretary V. Zhabitsky, Assistant Director for International Relations P. Bogolyubov, VBLHE Deputy Director A. Kovalenko and DLNP Deputy Director E. Syresin. During the meeting, technical aspects of the agreement on the associate membership of India at JINR were discussed. The Indian guests stressed that the scientific contacts between scientists from the Atomic Energy Department of India and their colleagues from JINR had been developing for about 40 years. Indian researchers are interested in further developing the cooperation; in particular, they would like to take part in superheavy elements search experiments, in fundamental research at the IBR-2 reactor and in design and construction of an accelerator and parts of a neutron source, which is planned to be produced in India.

The cooperation of JINR and Belarus is extending. In late September, on a visit to Minsk were FLNP Director Professor A. Belushkin, DRRR Leader Professor E. Krasavin and DRRR Chief Researcher RAS Academician M. Ostrovsky. They met with First Vice-President of the National Academy of Sciences of Belarus Academician P. Vityaz, and visited the Belorussian State University, as well as some enterprises. In the course of the visit, concrete forms of joint work were discussed on the use of nuclear physics set-ups for radiobiological research, on the development of methods to create new types of materials and some other directions.

A representative delegation from JINR took part in the opening ceremony of the exhibition «Poland at JINR», which took place at the Adam Mickiewicz University in Poznan on 8 October. The delegation also participated in a big scientific seminar devoted to cooperation of JINR with scientific centres and universities in Poland, and timed to mark the opening of the exhibition. Representing the JINR delegation were Director of the Institute Academician V. Kadyshesky, Assistant Directors V. Katrasev and P. Bogolyubov, heads of the laboratories, UC and leading scientists of JINR A. Belushkin, V. Voronov, Yu. Panebrattsev, T. Strizh, S. Ivanova. On the Polish side, participating in the ceremony were President of the National Atomic Energy Agency J. Niewodniczanski, Plenipotentiary of the RP Government to JINR A. Hryniewicz, Rector of the University S. Jurga, Dean of the Physics Department A. Dobek as well as teaching staff and students of the University.

A JINR delegation, including Vice-Director A. Sissakian, Corresponding Member of RAS, Chief Engineer I. Meshkov and leading researcher J. Manjavidze, was on a working visit to the Academic Town of Novosibirsk from 16–19 October. Working discussions on the issues of cooperation took place with the participation of a member of the RAS Presidium, Director of the Budker Institute of Nuclear Physics (INP) Academician A. Skrinsky, Rector of NSU RAS Corresponding Member N. Dikansky, Co-Chairman of the RAS Siberian Department RAS Corresponding Member G. Kulipanov, and other Siberian scientists.

At a scientific seminar of INP theorists and experimenters, A. Sissakian and J. Manjavidze presented reports «Thermalization in Hadron Processes» and «Topological Quantum Chromodynamics». The JINR delegation took part in the Institute's round-table discussion, during which A. Sissakian presented a report on JINR's scientific programme. Participating in the round-table discussion and seminars were heads and leading researchers of INP. A. Sissakian and I. Meshkov got acquainted in detail with the work of accelerator and experimental divisions INP, its experimental workshop, and also visited Novosibirsk University.

From 21–23 October, plenary sessions of the Resource Review Boards (RRB) took place in Geneva. In the course of the meetings the ongoing work and plans for realization of projects of experimental facilities at LHC were considered. The sessions were chaired by CERN Research Director Professor R. Cashmore. At the plenary meetings, talks were delivered by CERN Director-General L. Maiani, Technical Director H. Hoffmann and others. JINR Vice-Director Professor A. Sissakian took part in the sessions as an RRB member from JINR. Participating as experts were also N. Russakovich (ATLAS), I. Golutvin (CMS), A. Vodopianov (ALICE).

On 25 October a meeting was held of the joint CERN–JINR Committee on cooperation (R. Cashmore and A. Sissakian as co-chairmen). Participating in the meeting was JINR Director Academician V. Kadyshesky. After review reports made by R. Cashmore and A. Sissakian the leaders of the experiments gave talks on the status of activities and plans for 2003. A CERN–JINR teleconference took place, in the course of which JINR's latest developments in electronics, intended for joint experiments with CERN, were demonstrated. Participating in the meeting were V. Kekelidze, N. Russakovich, A. Malakhov, A. Olshevsky, P. Jenni, M. Della Negra, J. Schukraft and others.

V. Kadyshesky, A. Sissakian, V. Kekelidze were received by CERN Director L. Miani and had a continued talk on the issues of further cooperation. During their stay at CERN, V. Kadyshesky and A. Sissakian had a meeting with a number of leaders of the experiments in which JINR takes an active part.

In October JINR Director Academician V. Kadyshesky and Head of an LPP department Professor Yu. Panebrattsev were on a visit to the USA. They took part in celebrations connected with the 40th jubilee of the Stanford Linear Accelerator Centre (SLAC), one of the world's largest laboratories specializing in high-energy physics.

After SLAC, V. Kadyshesky and Yu. Panebrattsev visited the Brookhaven National Laboratory (BNL). Like JINR, it is a multidiscipline scientific centre, which in many respects defines the character of cooperation with JINR. In the course of the visit, plans of joint experiments at the new collider of nuclei and polarized protons RHIC were discussed. At present, the joint educational project «Online Science Classroom» is being successfully realized, which makes it possible to acquaint schoolchildren with the activities of BNL and JINR scientists in physics, molecular biology, ecology, chemistry and other natural sciences. The BNL Director and the JINR Director signed an agreement on their intention to reform this project into an International Internet Journal on Natural Sciences for schoolchildren.

In the course of the visit, meetings took place with the USA President's Adviser for Science and Technol-

ogy J. Marburger and heads of the USA Ministry of Energy. Issues connected with the final stage of preparation of the Agreement between the USA Government and JINR were discussed.

On 5–6 November Rector of the Korolev Aerospace Technical University, Director of the Institute of Image Processing Systems, Corresponding Member of RAS V. Soifer was in Dubna to visit JINR. At a scientific seminar at the Dzhelepov Laboratory of Nuclear Problems he delivered a report on the work on computer optics conducted under the guidance of Professor I. Sissakian (1938–1995). In the course of meetings a wide range of issues on scientific and technical cooperation was discussed. Participating in the meetings were JINR Vice-Director Professor A. Sissakian, Directors of laboratories Professors M. Itkis and N. Russakovich, FLNR Scientific Leader Corresponding Member of RAS Yu. Oganessian, IBR-2 Scientific Leader Professor V. Aksenov and others. Apart from that, V. Soifer visited DLNP, FLNR, and also the International University «Dubna».

On 20 November a ceremonial meeting dedicated to the 30th anniversary of the Institute of Nuclear Research and Nuclear Energy (INRNE) of the Bulgarian Academy of Sciences (BAS) took place in the Grand Hall of the BAS in Sofia. The INRNE was awarded the Gold Medal of the Bulgarian Academy of Sciences for successful development of the Bulgarian atomic science. Representatives of many Bulgarian institutes congratulated the staff of the Institute on the jubilee. On behalf of the JINR Directorate, an address of greetings and a gift were presented to the INRNE Directorate by Professor A. Malakhov. In the address, note was taken of the important role of the INRNE in the development of cooperation between Bulgarian scientists and their Dubna colleagues, as well as of the remarkable contribution of the Institute's staff members to the scientific achievements of JINR.

In late November JINR Director Academician V. Kadyshesky and Assistant Director for International Relations P. Bogolyubov were on a visit to Belgium and Spain with the aim of extending scientific cooperation between JINR and these countries of the European Union. During their stay in Belgium, V. Kadyshesky and P. Bogolyubov visited the International Solvay Institute for Physics and Chemistry in Brussels, where negotiations with the Institute's Director Professor I. Prigogine and Deputy Director Professor I. Antoniou took place.

At the invitation of the Supreme Council on Scientific Research of Spain, the JINR delegation visited two scientific centres located in Madrid, namely the Institute of Matter Structure and the Institute of Mathematics and Fundamental Physics. V. Kadyshesky

and P. Bogolyubov were received by President of the Supreme Council on Scientific Research of Spain Professor R. Tarrach. Preparation of protocols on cooperation with the Institute of Matter Structure and the Institute of Mathematics and Fundamental Physics has become one of the results of the visit to Madrid.

On 24 December on a visit to the Joint Institute for Nuclear Research were First Deputy Minister for Foreign Affairs V. Trubnikov, supervising in the Ministry of Foreign Affairs integrational processes in the CIS space, his assistant O. Petrin, and pilot-cosmonaut Yu. Baturin.

CONFERENCES AND MEETINGS HELD BY JINR

Eleven conferences were the largest among scientific conferences and workshops held at JINR in 2002.

The meeting «*New Model and Nuclear Methods in Biophysics and Biochemistry*» was held in Dubna on 24–25 January. The organizers of the meeting were BLTP, FLNP and DRRR. It had an aim to bring together those involved in biophysics and biochemistry research on the one hand and the physicists and mathematicians related to problems of physical support of biological experiments and mathematical modeling of biological structures on the other hand. The main activity was concentrated on potentials of JINR facilities and technique with reference to biological experiments; mathematical modeling of genetic structures and biochemical processes.

About 50 participants from JINR, leading institutes of Russia, Germany and Czechia attended the meeting. Fourteen reports on different questions were presented and wide discussions on all problems were held.

On 28 January – 2 February, Dubna hosted the IX international conference «*Mathematics. Computer. Education*», initiated by the interregional association «Women in Science and Education». The purpose of this conference is to integrate the efforts of Russian and foreign specialists directed towards developing science and higher education in Russia and other countries of CIS as well as preserving the traditions of the Russian science and education and their integration in the international community.

The conference was organized by the association together with the Joint Institute for Nuclear Research, Moscow State University, Pushchino Centre for Science, Central Institute of Economics and Mathematics

In the course of a meeting with the Institute's Directorate, issues of international cooperation and participation in research projects of JINR Member States were discussed, as well as the issue of perspective membership of other countries in JINR. Results of many years of cooperation of the Institute with CIS countries were also discussed.

Participating in the reception of the guests were JINR Vice-Director A. Sissakian, Chief Engineer I. Meshkov, Chief Scientific Secretary V. Zhabitsky, FLNR Director M. Itkis, Director of the Scientific Production Centre «Aspect» Yu. Nedachin and others. The guests visited the SPC «Aspect» and the Flerov Laboratory of Nuclear Reactions.

of RAS, Institute of Applied Mathematics of RAS, Institute of Philosophy of RAS. More than 300 scientists, higher school lecturers and students attended the conference. According to the long-standing traditions, mathematical simulation was a connecting element in the multidisciplinary subjects of the conference. The applications, presented primarily from biological sciences, step by step have moved to the sphere of medicine, sociology, ecology, etc.

Considerable interest was generated by the plenary sessions as well as the conference section meetings «Computers in Science and Education», «Computational Methods and Mathematical Simulation», «Mathematical Models in Chemistry, Biology, Ecology, and Medicine», «Mathematical Methods in Economics», «Humanitarian and Natural Science Education». The meeting devoted to research in biology and medical problems should also be noted, in particular, the reports «Mathematical Models of Skull Injuries and Eye Retina Surgery» by I. B. Petrov, «Biological Investigations at JINR» by E. A. Krasavin, «Direct Results of Radiotherapy in Dubna» by A. V. Iglin, and «A Model of Methods for Overcoming Hindrances» by M. V. Voronov. The lectures «Synergetics and Psychology» delivered by Professor S. P. Kurdyumov, Corresponding Member of RAS, and «Thinking and Discernment» by Professor D. S. Chernavsky generated considerable interest.

Physics presented in the reports delivered by JINR physicists attracted particular interest. JINR's veterans offered the conference participants the following reports: «Theorem of the Validity of Einstein's Principle of Equivalence» by N. A. Chernikov, «High-Energy Physics and Elementary Particle Physics at the Beginning of the 21st Century» by A. A. Tiapkin, and «Universe and Mankind» by V. A. Rusakov. All the lecturers

succeeded in combining their presentation of specific physics problems with slight remarks from the history of physics (whose participants they were) and its modern problems.

A special seminar was devoted to humanitarian and natural science education. To keep up the tradition, round-table discussions «Cultural Environment of Russia: Books, Journals, Conferences, Internet» and «People and Microorganisms: Social Life and Mathematical Models» were held. For the first time in the framework of the conference, an international workshop with participation of foreign scientists «Mathematical Models of Living Systems», chaired by Professor G. Yu. Reznichenko, Head of the association «Women in Science and Education», was organized. The report delivered by a leading specialist of RFBR O. A. Pletcheva «A New Program of the Russian Foundation for Basic Research (RFBR)» acquainted the conference participants with the activities and possibilities of the Foundation.

The conference attendees visited the JINR Laboratories.

On 4–6 March a seminar «*Particle and Nucleus Accelerators: Past, Present and Future*» (ISAPAN-02) was held at the International Conference Hall. It was dedicated to the memory of Academician V. I. Veksler, whose 95th anniversary was celebrated at that time.

«Today we gathered here to remember one of the most talented physicists who contributed enormously to the development of high energy physics», said JINR Director V. G. Kadyshevsky at the opening of the seminar. Reports by leading scientists of the Institute and other research centres, including DESY and CERN, were presented at the seminar. They reflected modern status of high energy physics and elementary particle physics. The reports evaluated the activities in joint international experiments and prospects of further research. Honorary Director of LPP Professor I. A. Savin marked, «The seminar is topical, but as it coincided with the anniversary of V. I. Veksler, it is also a memorial one». Due to this fact, historical reviews of the works by the outstanding scientist and memoirs about him were delivered at the seminar. The event illustrated how ideas pronounced by a famous scientist of the 20th century are continued and realized in modern science. The scientific programme of the seminar was presented at the Lebedev Physics Institute, RAS, where V. I. Veksler began his research career.

On 22–25 May, the *X International Seminar on the Interaction of Neutrons with Nuclei (ISINN-10)* took place in Dubna. The agenda of the seminar, annually held in Dubna, traditionally included the issues of neutron spectroscopy, nuclear structure and fundamental properties of the neutron. Scientists from JINR, Moscow, Saint Petersburg, Gatchina, Obninsk, Bul-

garia, Poland, Czechia, Slovakia, Germany, the USA, South Korea, and Algeria took part in the seminar. The total number of participants was over 140. JINR Vice-Director Professor A. N. Sissakian opened the Seminar. The reports of the session «Neutron Sources and Basic Instruments» presented by M. Daum of PSI and Y. Masuda of KEK, discussing ultracold neutron (UCN) sources of the new generation, aroused considerable interest. The session «Fundamental Symmetries in Reactions with Neutrons» was devoted to theoretical and experimental aspects of the fundamental mechanisms of spatial symmetry violation in interactions of neutrons with nuclei and to approaches to the search of effects causing violation of time reversal invariance. Each of three sessions devoted to methods of the neutron experiment followed the related theoretical session, which allowed the participants not only to learn the underlying ideas of the planned or realized experiments but also «pop into» the related experimental and computation «kitchen». As usual, vigorous discussions followed the reports devoted to ultracold neutrons. The authors of the very first experiments with UCN, A. V. Strelkov (JINR), A. Steyerl (University of Rhode Island), V. I. Morozov (the Kurchatov Institute), took part in the work of the session.

It is already a third time that FLNP (JINR) specialists in neutron activation analysis, who use neutrons as a tool in the realization of their numerous projects supported by grants of JINR Member-State Plenipotentiaries and IAEA, took part in the work of the seminar. The results of multielement analysis of moss samples (moss-biomonitoring technique) from Bulgaria, Poland, Slovakia, Czechia, Romania, Central Russia, Yugoslavia, China, and South Korea were summed up.

In an appropriate manner, the work of the seminar concluded with a bright lecture by Professor Yu. V. Gaponov (the Kurchatov Institute), who spoke on the evolution of the neutrino concept in the physics of particles in the twentieth century. His report summed up, in a way, many reports that were presented by ISINN participants on the problems of the weak interaction in physics, neutron beta decay, relationship between neutron nuclear physics and the Standard Model of Electroweak Interaction, as well as attempts to go outside the limits of SM over a ten-year history of the seminar.

VII International School-Seminar on Heavy Ion Physics was held at JINR on 27 May – 1 June. The school-seminar on heavy ion physics is organized by the Flerov Laboratory of Nuclear Reactions every 3–5 years. The Chairman of the Organizing Committee is Corresponding Member of RAS, Scientific Leader of FLNR Yu. Oganessian. The scientific programme of the event is traditional — nuclear reactions at low and intermediate energies; physics and chemistry of heavy and superheavy elements; nuclear fission dynamics; ra-

radioactive beams and properties of exotic nuclei; nuclear spectroscopy; new installations and their physics programme.

Two days of the school-seminar were devoted to the problems of heavy and superheavy nuclei. Elements 114 and 116 have been synthesized in Dubna in the last three years, the experiment on element 118 synthesis is under way. It obviously attracted the attention of colleagues from other scientific centres as such research is conducted in Germany, France and Japan. In this connection, one of the sessions was held at FLNR, where Yu. Oganessian, M. Itkis and G. Gulbekian made reports. The guests saw the facilities at the Laboratory and were informed on the research in the acceleration of radioactive beams DRIBs.

Questions of the mechanism of nuclear reactions at different energies (fusion–fission, quasifission and fragmentation) were discussed at the school-seminar. Considerable progress was marked in theory and acquisition of new experimental data with complex detecting systems. Chemical research of heavy ions reflects main concern in the properties of elements 112–114. Particular significance is seen in fission as a source of neutron-abundant isotopes of medium mass in the region of krypton, xenon, lead (especially, lead-132). Interest was aroused by the results concerning the first part of the periodic system — the structure of very light elements (hydrogen, helium, beryllium, carbon), especially those that are situated on the border of the nucleon stability. New super neutron-abundant nuclei were obtained in this region, their properties and decay modes are being studied.

About 190 physicists from Belgium, Great Britain, Germany, Egypt, Israel, India, Spain, Italy, Kazakhstan, China, Poland, Russia, Romania, Slovakia, the USA, Ukraine, Finland, France, Czechia, Switzerland, Japan and JINR took part in the school-seminar. Sixty-eight participants made reports, 16 among them were from JINR. There was a poster session, where about 40 posters were exposed.

The XVI International Baldin seminar on High Energy Physic Problems was devoted to relativistic nuclear physics and quantum chromodynamics. It was organized by JINR and the Advisory Board on Physics of Electromagnetic Interactions of the Russian Academy of Sciences and took place in Dubna at the International Conference Hall on 10–15 June.

For the first time this seminar was held without A. Baldin, but he, its initiator and organizer, remained in the memory of all participants who come traditionally to Dubna to attend «Baldin Autumn». The first words pronounced at the seminar were addressed to the memory of this outstanding scientist. In the early 1970s A. Baldin determined urgent aims of research in relativistic nuclear physics. They immediately led to the establishment of limits to the usage of the proton–neutron model of the atomic nucleus and the construc-

tion of the physical picture of nuclear matter on the level of subnucleon parts — quarks and gluons. The study of the nucleus–nucleus collisions spread to the region of energy where the principles of relativity theory play a dramatic role. The new trend of physics research — relativistic nuclear physics — was based on the achievements of quantum field theory, elementary particle physics, nuclear physics and accelerator physics.

The scientific programme of the seminar was rich, it contained 16 most vital scientific topics connected to theoretical as well as to methodological, accelerator aspects of the development of relativistic nuclear physics and quantum chromodynamics. Traditionally, Dubna's international scientific community was widely represented — scientists practically from all leading research centres of the world participated in the seminar.

On 17–19 June the *II Workshop on Investigations at the IBR-2 Reactor* organized by JINR with the support of RFBR was held. The objective of the workshop was a comprehensive discussion of the IBR-2 scientific programme and the programme for the development of the IBR-2 spectrometer complex.

Today, under the IBR-2 user programme, researchers from about 30 countries conduct annually over 100 experiments on twelve IBR-2 spectrometers. Also work, under agreements with the Ministry of Industry, Science and Technology and the Ministry of Atomic Energy, RF, is being carried out. Over 100 scientists from JINR Member and non-Member States participated in the workshop. The workshop agenda included review talks on the main directions of research and modernization of the reactor and spectrometers, topical sections on the prospects of the research and a poster session on particular experiments done last year. In addition, a contest of reports submitted by young scientists was conducted.

On 26 August a *European School of Young Scientists* on the topic of high energy physics opened in Pilos, Greece. It was jointly organized by CERN and JINR. These schools have been traditionally held for 30 years, over the last 12 years they have been held annually and before — every two years. Twenty-six young scientists from JINR and other scientific centres in JINR Member States, including 2 graduates from the «Dubna» university, came to Pilos. On the JINR side Professor A. Sissakian, A. Olshevsky and T. Donskova worked in the Organizing Committee of the school.

JINR Vice-Director A. Sissakian made a lecture about the JINR scientific programme. Among other lecturers were C. Quig (USA), A. De Ruhula (CERN), I. Iliopoulos (Greece), Yu. Dokshitser (France/Russia) and others. Among the discussion leaders was A. Gladyshev from BLTP, JINR.

During the visit to Greece, JINR Vice-Director A. Sissakian took part in the meeting of the Organizing Committee of the next school, which would take place in Tsakhkadzor, Armenia, in August–September, 2003.

The annual *32nd International Symposium on Multiparticle Dynamics, ISMD XXXII*, was held on 7–13 September in Alushta (the Crimea, the Ukraine), at the «Dubna» guest house of the Joint Institute for Nuclear Research. The symposium was held for the first time on the territory of CIS and was organized by JINR and the Bogoliubov Institute of Theoretical Physics (ITP) of the National Academy of Sciences of the Ukraine. The Organizing Committee was headed by Professor A. Sissakian (JINR) as Chairman and Professor L. Jenkowski (ITP) as Co-chairman.

More than a hundred scientists from 20 countries, as well as from CERN and JINR, took part in the symposium. The scientific themes covered a wide range of modern problems in elementary particle production physics, i. e., fluctuations and particle correlations, diffraction processes, soft and hard processes in quantum chromodynamics, heavy ion physics, particle production with large multiplicity, cosmological problems in astrophysics, etc. They were reflected in 80 reports by the symposium participants. Professors R. Lednitsky (JINR), D. Dunlop (USA), F. Antinori (Italy), J. Manjavidze (JINR) and I. Dremin (Russia) presented review reports.

The ISMD XXXII scientific programme was opened with a special memorial session dedicated to the memory of Professor Bo Anderson, an outstanding Swedish scientist, one of the active organizers and participants of ISMD events, who died suddenly in March, 2002. Professors G. Gustafson (Sweden), M. Samure (Great Britain), F. Soderberg (Sweden) and A. De Angelis (Italy) made reports on his scientific heritage, latest works and ideas.

An important part of the symposium was dedicated to the obvious success in heavy ion physics (SPS, CERN; RHIC, USA), and deep analysis of the data obtained in LEP (CERN) experiments. It was marked that theoretical perception of the problems tied to particle production at very high multiplicities is very important in modern physics (reports by J. Manjavidze, A. Sissakian, L. Jenkowski) together with a foundation of proposals to prepare new experiments at the following accelerators: Russia's U-70 (V. Nikitin); CERN's LHC (Yu. Kulchitsky) and USA's Tevatron (A. Korytov).

Traditionally, conclusions of the current symposium were made by the Council of Elders, which includes an international community of scientists. The Council meeting was held under the chairmanship of Professor H. Schmits (Germany). The Council marked the high scientific level of the reports and good organization of the symposium on the whole.

The symposium was financially supported by UN-ESCO, the Russian Foundation for Basic Research, the RF Ministry of Industry, Science and Technology and the Bogoliubov–Infeld programme. The Council of Elders took a decision to continue the tradition of ISDM symposia and adopted the country-organizer in 2003. The 33rd symposium was planned to be held in 2003 in Cracow (Poland).

On 30 September – 6 October the Laboratory of Information Technologies of the Joint Institute for Nuclear Research hosted the *V International Congress on Mathematical Modeling*. The Organizing Committee was chaired by Professor I. V. Puzynin, LIT Director. The honorary chairman was Academician A. A. Samarsky (IMM, RAS) and co-chairmen were B. N. Chetverushkin (IMM, RAS), Professor D. Morgan (LLNL, USA), and Professor Chin Kun Hu (Academy Sinica, Taiwan). More than 300 scientists from 12 countries, including Japan, Portugal, Taiwan, France, Germany, Sweden, Bulgaria, Armenia, Belarus, Kazakhstan, and Ukraine attended the scientific forum. Thirty-nine plenary talks, 238 section reports and 37 posters were presented.

The plenary talks were devoted to a broad spectrum of topical problems of mathematical simulation in various fields of science — from mathematics and informatics to humanitarian and social disciplines. The report delivered by Corresponding Member of RAS A. B. Zhizhchenko (Moscow) was devoted to the creation of the Russian mathematical portal Math-net.ru. Usage of parallel computing algorithms and their applications to fundamental and applied research was reported by Corresponding Member of RAS A. V. Zabrodin (Moscow). The talk presented by Professor V. D. Lakhno (Pushchino) overviewed the main directions of computing biology. Particular attention was given to the use of high-performance computing systems in biology and biocomputer science. Academician A. M. Lipanov (IAM, Izhevsk) reported on modeling and theoretical investigations of turbulent flows. He presented a model of compressible medium described by a system of hydromechanical equations. The lecture delivered by Professor I. V. Puzynin (JINR) was devoted to the analysis of numerical modeling in the dynamics of Hamiltonian systems, modeling of transients in adsorption systems as well as to research on the processes in metal samples irradiated by pulsed ion sources with the help of the molecular dynamics methods. Corresponding Member of RAS B. N. Chetverushkin (Moscow) reviewed the problems originating in the numerical modeling with the help of high-performance multiprocessor computing systems with a distributed architecture of storage.

The section reports were dedicated to the results of research conducted in the framework of scientific directions represented in 12 congress sections. For the last few years the detailed dynamic research in

various macromolecular systems has acquired importance in view of their wide application in different areas of human activity: biotechnology, bioengineering, pharmacology, microelectronics, medicine, etc. At the same time, the clearly experimental research techniques sometimes do not provide detailed information on the properties of the systems of interest with a proper spatial and temporal order of comprehensive data. Such information can be obtained with the help of imitation modeling methods of molecular dynamics and Monte-Carlo. The computer simulation of molecular systems has received wide recognition in the world, especially for the last few years, in view of the intensive growth of the level of computer facilities — their high performance, memory size, etc. The molecular modeling is of particular value for the development and improvement of education and staff retraining in view of fresh and intensively developing advanced technologies.

The presented reports have shown that the problems arising in modern fields of science are of high complexity, they are multidimensional and multiparametric. The congress participants came to a common opinion on expediency of the development of computer simulation methods with reference to the problems that have no analytical solutions.

From 15 to 17 October the all-Russian conference «*Digital Libraries: Advanced Methods and Technologies, Digital Collections*» (RCDL'2002) was held at the Joint Institute for Nuclear Research. Participating in the conference were 104 specialists from 16 Russian cities and 15 specialists from Hungary, Germany, Latvia, Moldova, the USA and the Ukraine. Ninety-seven extended theses of reports were submitted to the conference. As a result of a review conducted by the programme committee of the conference, 59 session reports and 13 poster presentations were selected. The Conference Proceedings were published before the opening of the conference. The work on organizing and holding the conference was supported by grants of the RFBR and Ministry of Industry, Science and Technology, RF.

The all-Russian conference of 2002 is the fourth one in this direction. The principal objective of this series of the conference is to promote the constituting of a community of Russian experts involved in research and development related to digital libraries. The conference offers such a community an opportunity to discuss ideas and outcomes and to make contacts for closer cooperation, promotes the study of international experience, development of the international cooperation on digital libraries, and focuses attention on advanced investigations and technologies.

During the conference, the International Expert Meeting of the UNESCO Institute of Information Technologies in Education (IITE) was held to consider the status of electronic libraries in education. The aim of the UNESCO IITE Meeting was to discuss the analytical review «Digital Libraries in Education» elaborated by an international group of experts and presented by Professor L. A. Kalinichenko (IAR, RAS, Moscow).

Among the talks given at the conference, special interest was arisen by the review of professionally oriented community aspects of creating narrowly profiled digital libraries for education (on the example of DLESE — the Digital Library for Earth System Education) made by M. Marlino (UCAR, USA). A new approach to organization of educational courses related to the well-known project of the Alexandria Digital Library Project was considered in the talk given by A. Ushakov (University of California in Santa Barbara). Digital libraries in the field of astronomy (The Astrophysics Data System) and for airspace education were presented in the reports made by E. B. Kudashev (Institute of Cosmic Research, RAS), E. Guenther (Smithsonian Astrophysical Observatory). One of the topical problems, Data Grid and perspectives of using this architecture in digital libraries, was touched upon in the talks given by I. Zaslavsky (USA) and V. V. Korenkov (LIT, JINR). Detailed information on the outcome of the conference and contents of the UNESCO IITE Expert Meeting materials is available on the conference site <http://rcdl2002.jinr.ru>.

PARTICIPATION OF JINR IN INTERNATIONAL CONFERENCES

In 2002, JINR scientists and specialists took part in 231 international conferences.

The largest delegations represented the Joint Institute for Nuclear Research at the Workshop on Chemical Separator for Superheavy Elements (Darmstadt, Germany), the 14th International Conference on Radiochemistry (Mariánské Lázně, Czech Republic), the 10th International Conference on Deep Inelastic Scat-

tering «DIS-2002» (Cracow, Poland), the 14th International Conference on Electromagnetic Isotope Separators «EMIS-14» (Victoria, Canada), the 9th International Seminar on Study of Condensed Matter with Neutron Scattering Method (Poznan, Poland), Meeting on Research Programme of Nucleus–Nucleus Collisions at GSI (Darmstadt, Germany), European Conference on Neutron Pulse Source ESS (Bonn, Germany), interna-

tional seminar «Quarks-2002» (Velikii Novgorod, Russia), the 8th European Conference on Charged Particle Accelerators (Paris, France), the 7th International Conference on Nuclear-Analytical Methods in Life Science «NAMLS-7» (Antalia, Turkey), workshop-seminar «Topology in Condensed State Physics» (Dresden, Germany), the 52nd International Conference on Nuclear Spectroscopy and Atomic Nucleus Structure (Moscow, Russia), XI international colloquium «Quantum Groups and Integrable Systems» (Prague, Czech Republic), XXIV International Colloquium on Theory Group Methods in Physics «GROUP-24» (Paris, France), the 16th International Conference on Ultrarelativistic Nucleus–Nucleus Collisions (Nantes, France), International Conference on Theoretical Physics «TH-2002» (Paris, France), the 31st International Conference on High Energy Physics (Amsterdam, the Netherlands), Symposium on Nuclear Clusters: from Light Exotic to Superheavy Nuclei (Rauischholzhausen, Germany), international conference «Diffraction-2002» (Alushta, Ukraine), the 11th International Symposium on Capture Gamma-Ray Spectroscopy and Related Topics (Pruhonice, Czech Republic), international school on astrophysics «The Early Universe and the Cosmic Microwave Background» (Palermo, Italy), Workshop on Dubna–Marburg–Jülich Collaboration (Marburg, Germany), the 15th International Symposium

on Spin Physics «Spin 2002» (Brookhaven, USA), XXXIII European Meeting on Cyclotrons (Warsaw, Cracow, Poland), international conference «Hadron Structure '02» (Herl'ani, Slovak Republic), Russian conference «Scientific Service in Internet» (Novosibirsk, Russia), Russian Conference on Accelerators (Obninsk, Russia), XVI International Conference on Particles and Nuclei «PANIC '02» (Osaka, Japan), XVII Meeting on the Use of Neutron Scattering in Condensed Matter Research (Gatchina, Russia), international symposium «New Projects and Trends in Nuclear Physics Research» (Messina, Italy), international conference «Fission and Properties of Neutrino-Rich Nuclei» (Sinabel, USA), International Symposium on Physics of Unstable Nuclei (Halong Bay, Vietnam), session-conference «Physics of Fundamental Interactions» (Moscow, Russia), the 5th international conference «Renormalization Groups» (RG-2002) (Tatranska Štrba, Slovak Republic), Joint JINR–Romania School on Neutron Application (Baia Mare, Romania), international conference «Prague-Spin-02» (Prague, Czech Republic), European School on High Energy Physics (CERN–JINR School) (Athens, Greece), XXXII International Symposium on Multiparticle Dynamics (Alushta, Ukraine), International School on Modern Physics (Ulaanbaatar, Mongolia).

Development of the JINR International collaboration and relations during the years 1965–2002

| | 1965 | 1975 | 1985 | 1990 | 1995 | 2000 | 2002 |
|--|------|------|------|------|------|------|------|
| 1. Number of visits to JINR by specialists from Member States (excluding participants in JINR conferences) | 203 | 1026 | 1469 | 1050 | 299 | 425 | 457 |
| 2. Number of visits by JINR specialists to Member States | 171 | 474 | 600 | 778 | 682 | 682 | 814 |
| 3. Number of conferences and meetings organized by JINR | 19 | 42 | 49 | 44 | 52 | 54 | 47 |
| 4. Number of visits to international conferences and research centres of non-Member States | 69 | 131 | 119 | 437 | 1451 | 1946 | 2022 |
| 5. Number of visits of scientists from non-Member States | 27 | 226 | 144 | 563 | 1036 | 990 | 631 |
| 6. Number of JINR Fellows | | 11 | 3 | 16 | 28 | 17 | 24 |

LIST OF CONFERENCES AND MEETINGS HELD BY JINR IN 2002*

| No. | Name | Place | Date | Number of participants |
|-----|--|----------------------------------|-------------------------|------------------------|
| 1. | 91st session of the JINR Scientific Council | Dubna | 17–18 January | 120 |
| 2. | Workshop «New Models and Nuclear Methods in Biophysics and Biochemistry» | Dubna | 24–26 January | 135 |
| 3. | Conference «Mathematics. Computer. Education» | Dubna | 28 January – 2 February | 200 |
| 4. | VI Conference of JINR Young Scientists and Specialists | Dubna (Ratmino) | 4–9 February | 130 |
| 5. | 3rd School on Application of Neutron Scattering and Synchrotron Radiation | Dubna | 8 February – 7 March | 90 |
| 6. | Meeting of the JINR Finance Committee | Dubna | 21–22 February | 80 |
| 7. | 24th Workshop on Experiments with the IHEP–JINR Neutrino Detector and the NOMAND Experiment | Dubna | 23–25 February | 30 |
| 8. | XII Meeting of the Steering Committee for the BMBF–JINR Agreement Implementation and the Use of the JINR Facilities | Dubna | 25–26 February | 20 |
| 9. | International Seminar in Memory of Professor M. I. Soloviev | Dubna | 1 March | 49 |
| 10. | International seminar «Accelerators of Particles and Nuclei: Past, Present and Future» (ISAPAN-02; in memory of Academician V. I. Veksler) | Dubna | 4–6 March | 200 |
| 11. | 5th international conference «Renormalization Groups» (RG-2002) | Slovak Republic, Tatranska Štrba | 11–15 March | 70 |
| 12. | JINR–Romania workshop «Advanced Materials and Their Characterization» | Dubna | 18–19 March | 55 |
| 13. | Meeting of the Committee of Plenipotentiaries of the JINR Member States | Dubna | 21–23 March | 110 |
| 14. | VI research workshop «Nucleation Theory and Applications» | Dubna | 2–28 April | 45 |
| 15. | Meeting of the Programme Advisory Committee for Particle Physics | Dubna | 15–16 April | 45 |
| 16. | Conference of the Russian Satellite Communication Network Operators and Users | Dubna | 16–19 April | 200 |
| 17. | Meeting of the Programme Advisory Committee for Condensed Matter Physics | Dubna | 18–19 April | 75 |
| 18. | Meeting of the Programme Advisory Committee for Nuclear Physics | Dubna | 22–23 April | 100 |
| 19. | Workshop «Exotic Nuclei Structure Research on the Nuclotron's Beams» | Dubna | 25–26 April | 35 |
| 20. | 10th International Seminar on Interaction of Neutrons with Nuclei (ISINN-10) | Dubna | 22–25 May | 140 |
| 21. | Workshop on the Experiments at the EXCHARM Installation | Dubna | 24–25 May | 40 |
| 22. | VII International School-Seminar on Heavy Ion Physics | Dubna | 27 May – 1 June | 180 |
| 23. | International school «Heavy Quark Physics» | Dubna | 27 May – 5 June | 45 |
| 24. | III international workshop «Very High Multiplicity Physics» | Dubna | 3–5 June | 50 |

*A number of conferences was held in association with other organizations.

| No. | Name | Place | Date | Number of participants |
|-----|---|---------------------------|-----------------------------|------------------------|
| 25. | 92nd session of the JINR Scientific Council | Dubna | 6–7 June | 120 |
| 26. | XVI International Baldin Seminar on High Energy Physics Problems | Dubna | 10–15 June | 167 |
| 27. | Baikal Collaboration Workshop | Dubna | 11–13 June | 45 |
| 28. | Workshop on the Investigations at the IBR-2 Reactor | Dubna | 17–19 June | 130 |
| 29. | VI School of JINR Young Scientists and Specialists | Dubna | 21–23 June | 90 |
| 30. | School «Nuclear Medicine in the 21st Century» | (Lipnya) Dubna | 23–30 June | 70 |
| 31. | 3rd Russian–Japanese Seminar on Technetium | Dubna | 24–28 June | 75 |
| 32. | Joint JINR–Romania Summer School on Neutron Application | Romania, Baia Mare | 1–7 July | 50 |
| 33. | Meeting of the Control Commission of the JINR Finance Committee | Dubna | 4–5 July | 20 |
| 34. | International workshop «Quantum Gravity and Superstrings» | Dubna | 11–18 July | 50 |
| 35. | International workshop «Praha-Spin-2002» | Czech Republic, Prague | 14–27 July | 145 |
| 36. | DAAD summer school «Quantum Statistics of Many-Particle Systems» | Dubna | 21 July – 10 August | 60 |
| 37. | European School on High-Energy Physics (a CERN–JINR school) | Greece, Athens | 24 August – 7 September | 130 |
| 38. | Conference «Prospects of the Satellite Communication and Broadcasting Development in Russia and CIS (the Commonwealth of Independent States)» | Dubna | 3–6 September | 200 |
| 39. | XXXII International Symposium on Multiparticle Dynamics | Ukraine, Alushta | 7–13 September | 100 |
| 40. | International School on Contemporary Physics (ISCP-2002) | Mongolia, Ulaanbaatar | 9–19 September | 80 |
| 41. | International Congress on Mathematical Modeling | Dubna | 30 September – 6 October | 450 |
| 42. | Fourth all-Russian scientific conference «Digital Libraries: Advanced Methods and Technologies, Digital Collections» (RCDL-2002) | Dubna | 15–17 October | 150 |
| 43. | Meeting of the Programme Advisory Committee for Particle Physics | Dubna | 11–12 November | 100 |
| 44. | Meeting of the Programme Advisory Committee for Nuclear Physics | Dubna | 14–15 November | 100 |
| 45. | Meeting of the Programme Advisory Committee for Condensed Matter Physics | Dubna | 21–22 November | 75 |
| 46. | Baikal Collaboration Workshop | Dubna | 2–7 December | 45 |



Dubna, 17–18 January.
The 91st session of the JINR Scientific Council
and the round-table meeting
«Belarus at JINR», held in its framework





Dubna, 6–7 June. The 92nd session of the JINR Scientific Council



Dubna, 21–22 March.
A regular session of the Committee
of Plenipotentiaries of the
Governments of the
JINR Member States.
A visit to the Flerov Laboratory
of Nuclear Reactions



Dubna, 26 February. The 12th meeting of the Joint BMBF–JINR Steering Committee. The signing of the meeting Protocol



Dubna, 15 April.
Members of the Programme Advisory
Committee for Particle Physics

Dubna, 29 November. Chairman of the Federation Council of the RF Federal Assembly S. Mironov (centre) visits Dubna





Dubna, 29 January. The visit of a scientific delegation of Greece to JINR, headed by General Secretary on Research and Technology of the Ministry for Development of Greece D. Deniozos (third from left)



Prague, 7–10 April.
JINR delegation in Czechia.
A meeting at the Ministry of Industry
and Trade of the Czech Republic



Dubna, 3 September.
Extraordinary and Plenipotentiary
of Armenia in Russia A. Smbatian
(second from right) visits JINR.
A meeting at the Flerov Laboratory
of Nuclear Reactions



Dubna, 7 May. Indian Ambassador to the Russian Federation K. Raghunath (centre) visits JINR



Dubna, 23 April.
A representative delegation from the
US Department of Energy (DOE) visited JINR.
Deputy Minister R. Card and JINR Director
V. Kadyshevsky signed the joint Declaration of Intent



Brussels (Belgium), November.
A meeting at the International Solvay Institute
for Physics and Chemistry.
Left to right: JINR Director V. Kadyshevsky,
Baron J. Solvay and ISIPC Director I. Prigogine



Bucharest, 11 June. The opening of the CERN–JINR exhibition «Science Bringing Nations Together» at the Ministry of Education and Science of Romania



Poznan (Poland), 8 October. The opening of the photo exhibition «Poland at JINR» at the Adam Mickiewicz University. University Rector Professor S. Lorenc is speaking



Scientific Production Centre «Aspect». JINR's guest First Deputy Minister for Foreign Affairs of RF V. Trubnikov (second from left) is acquainted with the centre's produce



Dubna, 4 March. International seminar «Particle and Nuclei Accelerators: Past, Present and Future» (ISAPAN-02) dedicated to the memory of Academician V. Veksler



Dubna, 27 May. Participants of the International School on Heavy Quark Physics

Alushta (Crimea), 7–13 September. The XXXII International Symposium on Multiparticle Dynamics





Dubna, 26 March. The Day of JINR Foundation. On the stage of the culture centre «Mir» are the laureates of the competition among Dubna teachers — JINR's scholarship 2002 holders

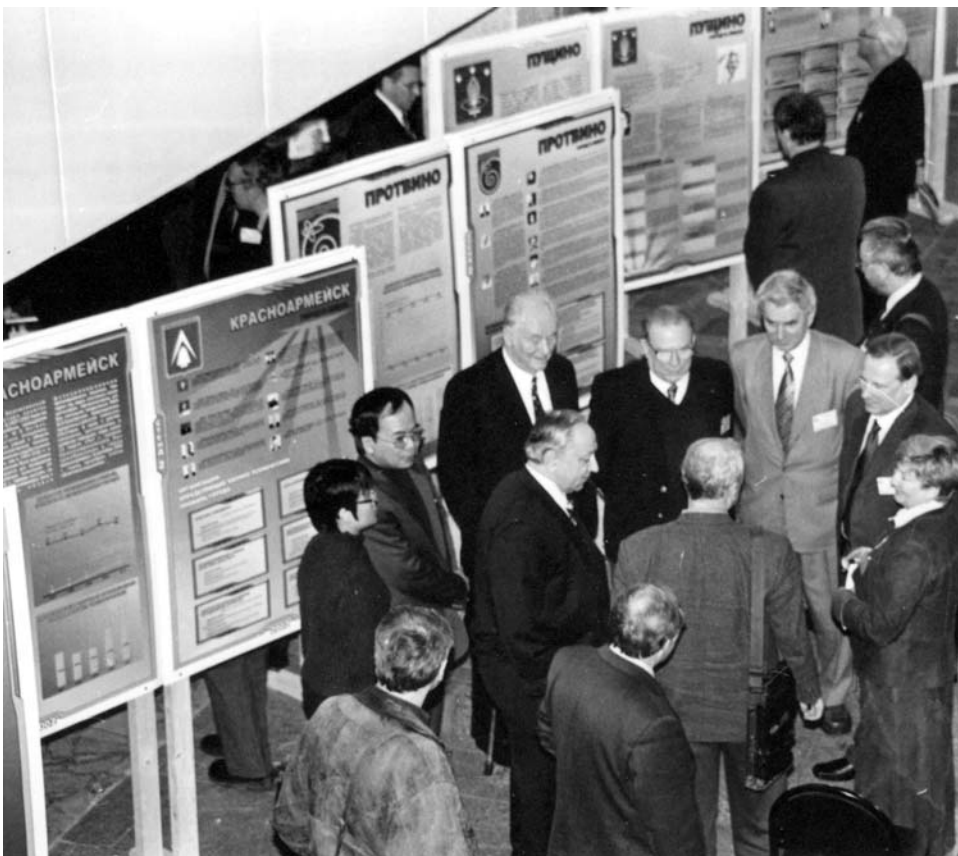

Dubna, 24 December. Participants of the international conference «Intellectual Bridge Russia–West»

RESEARCH AND EDUCATIONAL PROGRAMMES OF JINR



BOGOLIUBOV LABORATORY OF THEORETICAL PHYSICS

In 2002, at the Laboratory, studies were continued on three first-priority themes: «Fields and Parti-

cles», «Theory of Nuclei and Other Finite Systems», and «Theory of Condensed Matter».

FIELDS AND PARTICLES

Research in the *Fields and Particles* division of BLTP covers a wide field of activity in *modern mathematical physics*, *quantum field theory* (QFT), and *theoretical particle physics*.

The topics of main focus in modern mathematical physics and quantum field theory are:

- Supersymmetry and superstrings;
- Integrable models, noncommutative field theories;
- Nonperturbative approaches to QCD;
- Quantum gravity and cosmology.

Phenomenology of particle physics includes the Standard Model of fundamental interactions and its extension as well as high- and low-energy hadron physics, and neutrino physics. The main topics are:

- SUSY and Higgs boson search;
- New trends in neutrino physics;
- QCD structure functions;
- Spin and polarization phenomena;
- Chiral model and meson spectroscopy;
- Very high multiplicity physics.

Below one can find a short description of selected results obtained at BLTP in modern mathematical physics, quantum field theory, and phenomenology of particle physics.

The superconformal structure of coset superspaces with the $AdS_m \times S^n$ bosonic subspaces was studied. Contrary to the widespread opinion, the coset supermanifolds $AdS_2 \times S^2$, $AdS_3 \times S^3$ and $AdS_5 \times S^5$, appearing as solutions of $D = 4, 6, 10$ supergravities, were found to be not superconformally flat. A group-

theoretical explanation of this fact was provided and some of its applications in string theory were discussed. In particular, it was argued that some results obtained under the assumption of superconformal flatness should be revised [1].

A graded bracket operation that generalizes the graded commutator of superalgebras on the space of graded operators with involution is proposed. The continuous limit of the $N = (1|1)$ Toda lattice hierarchy — the $N = (1|1)$ dispersionless Toda lattice hierarchy — is obtained. Its Lax representation, where the generalized graded bracket goes over into the corresponding Poisson bracket on the graded phase space, is derived [2].

Nonperturbative solutions to the nonlinear field equations in the NS sector of cubic as well as nonpolynomial (super)string field theory can be obtained from a linear equation which includes a «spectral» parameter λ and a coboundary operator $Q(\lambda)$. Employing a generalization of solution-generating techniques (the splitting and the dressing methods), we demonstrate how to construct nonperturbative classical configurations of both $N = 1$ superstring and $N = 2$ fermionic string field theories. With and without $u(n)$ the Chan–Paton factor, various solutions of the string field equation were presented explicitly [3].

During 2002, the investigation of the three-dimensional spin integrable models was continued. The starting point of the research of these models is a good parametrization of the corresponding Boltzmann

weights or a sufficient number of solutions for the tetrahedron equation, which provides the integrability of the model on the three-dimensional lattice. In order to find these solutions, an auxiliary discrete classical integrable model for the three-dimensional cubic lattice associated with the quantum tetrahedron equation was investigated. The generic solution to the discrete equation of motion of the classical system in terms of the algebraic geometry was found. These solutions expressed in terms of higher genus theta functions provide free parametrization of the modified tetrahedron equation. Imposing the boundary conditions allows one to identify the algebraic curves which define these theta functions with spectral curves of the classical system. The periodic boundary conditions make it possible to find solutions to the usual tetrahedron equation in terms of higher genus theta functions [4, 5].

The local behaviour of static solutions of a general $(1+1)$ -dimensional dilaton gravity theory coupled to scalar fields and Abelian gauge fields near horizons was studied. This type of model includes, in particular, reductions of higher dimensional theories invariant under a sufficiently large isometry group. The solution near the horizon can in general be obtained by solving a system of integral equations or in favourable cases in the form of a convergent series in the dilaton field [6].

Integral transformations of the QCD invariant (running) coupling and of some related objects were con-

sidered. Special attention is paid to the Fourier transformation, that is, to a transition from the space-time to the energy-momentum representation. The conclusion is that the condition of possibility of such a transition provides us with one more argument against the real existence of unphysical singularities observed in the perturbative QCD. The second one results in a technical comment on the way of «translation» of some singular long-range asymptotic behaviours to the infrared momentum region. It relates to the recent ALPHA collaboration results on the asymptotic behaviour of the QCD effective coupling obtained by lattice simulation [7].

It is shown that the observed excess of positrons in cosmic rays observed by the HEAT and AMS collaborations may be explained by the annihilation of neutralinos from the Dark matter in galactic halo. The estimated neutralino mass ~ 100 GeV is compatible with the global fit to all the low-energy data within the Minimal Supersymmetric Standard Model [8].

Using our last year's result on the z -dependence of the Collins analyzing power $H_1^\perp(z)/D_1^\perp(z) = (0.33 \pm 0.06)z$, responsible for the left-right asymmetry in fragmentation of a transversally polarized quark, we obtained the predictions for single-spin asymmetries of pions and kaons in semi-inclusive deep inelastic scattering of unpolarized positrons off longitudinally polarized deuteron in HERMES (DESY) kinematics. Preliminary data of the experiment are in rather good agreement with our predictions (see the figure).

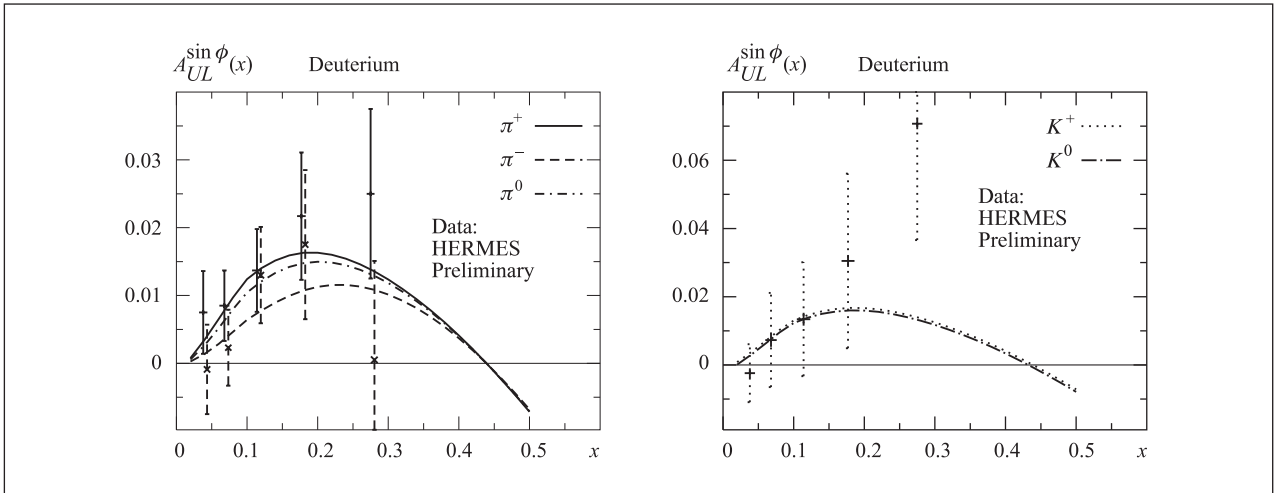

Similar predictions for the COMPASS (CERN) experiment with a longitudinally and transversally polarized target are also prepared for publication.

The first information on the twist-3 quark distribution function $e(x)$ is extracted from measured spin asymmetry with a nonpolarized target but a polarized electron beam (CLAS (JLab) experiment) [9].

Recent data of lattice measurements of the gauge-invariant nonlocal scalar quark condensates are analyzed

to extract the short-distance correlation length, $1/\lambda_q$, and to construct an admissible Ansatz for the condensate behaviour in coordinate space. The correlation length values appear to be in a good agreement with the well-known QCD SR estimates of the mixed quark-gluon condensate, $1/l_{\text{latt}}^2 \approx \lambda_q^2 = \langle \bar{q}(ig\sigma_{\mu\nu}G_{\mu\nu})q \rangle / \langle \bar{q}q \rangle = 0.4\text{--}0.55 \text{ GeV}^2$ [10].

A structure function approach to radiative corrections (RC) in DIS experiments was proposed. The «re-

turning to resonance» mechanism was used to simplify the procedure of taking RC into account for Drell–Yan process. Based on explicit calculation in two lowest orders of perturbation theory we construct the cross section in the $y \rightarrow 1$ region obeying renormalization group equations and including the Sudakov-like form factor suppression [11].

RC to the $K^\pm \rightarrow \pi^0 e^\pm \nu$ were considered (the so-called K_{e3}^\pm decay). This decay is the best way to extract the value of the V_{us} element of the CKM matrix. The radiative corrections become crucial if one wants a precise value of V_{us} . The necessity of precise knowledge of V_{us} and the contradiction between the existing results were the motivation of the work. The whole character of small lepton mass dependence based on the renormalization group approach was established. An explicit evaluation of the structure-dependent photon emission based on ChPT in the lowest order is given. The accuracy of results to be estimated is at the level of 1%. The value of the CKM matrix element is found $|V_{us}| = 0.2172 \pm 0.0055$ [12].

The S -matrix thermodynamical approach was developed to describe processes of hadron multiparticle production. Based on this approach, the phenomenon of thermalization of the finite state was predicted in the VHM region and later confirmed by the preliminary data obtained in STAR experiments (RHIC, BNL) [13].

On the basis of a combined reanalysis of the available data on the processes $\pi\pi \rightarrow \pi\pi, K\bar{K}$ in the channel with the vacuum quantum numbers, the $f_0(600)$ state with properties of the σ meson is shown to exist. The result on this state is added to the database of a new issue of the «Review of Particle Physics» of 2002. The existence of the $f_0(600)$ meson and obtained $\pi\pi$ -scattering length ($a_0^0(\pi\pi) \approx 0.27m_{\pi^+}^{-1}$) points to the linear realization of chiral symmetry [14].

THEORY OF NUCLEI AND OTHER FINITE SYSTEMS

In 2002, investigations within the area «Theory of Nuclei and Other Finite Systems» were carried out in accordance with the four projects:

- Nuclear structure under extreme conditions;
- Dynamics and manifestation of structure in nuclear and mesoscopic systems;
- Few-body physics;
- Relativistic nuclear dynamics.

The following main results were obtained in the field of *nuclear structure theory*:

A finite-rank separable approximation for particle-hole random phase approximation calculations with Skyrme interactions was extended to take into account

The nonperturbative contribution to the asymptotics of the quark form factor is found within the instanton model of the QCD vacuum, using the Wilson loop method. It is demonstrated that instanton effects produce significant corrections to the perturbative part at the momentum transfer squared of the order of 1 GeV^2 [15].

The pseudoscalar meson transition form factors for the processes $\gamma^*\gamma \rightarrow P$ and $\gamma^*\gamma^* \rightarrow P$ with $P = (\pi, \eta, \eta')$ at space-like photon momenta were calculated within the standard NJL model and the effective quark-meson model with the nonlocal interaction induced by instanton exchange. The leading asymptotics for the form factors and the light-cone meson distribution amplitudes of twist 2 and 4 were found [16].

Using the recently published SNO solar neutrino results, the contribution of the boron neutrinos to the event rate of the HOMESTAKE solar neutrino experiment was determined. This allows one to determine in a model-independent way the flux of beryllium monochromatic neutrinos and to predict an expected event rate in a future BOREXINO solar neutrino experiment [17].

A solution was suggested to the problem of the Dark energy $\Omega_\Lambda = 0.7$ within an alternative cosmological scenario, where the evolution of distances in the standard approach is replaced by evolution of the masses of all elementary particles in a stationary universe with the help of a conformal transformation where the dynamics is given by a massless scalar field [18]. The magnitude–redshift relation predicted by the present approach is in good agreement with data from supernovae type Ia including the most distant one at $z = 1.7$ without requiring a cosmological constant. For $z > 1.7$ our prediction deviates significantly from that of the standard cosmology and can be tested by future data [19].

the pairing correlations. This gave a possibility to solve the RPA problem in a very large configuration space. The method was applied to study properties of low-lying quadrupole and octupole vibrational states in nuclei away from stability [20].

Total ordinary muon capture rates were calculated on the basis of the quasiparticle random phase approximation for few spherical nuclei. Velocity-dependent terms were evaluated with single-particle wave functions having the correct asymptotic behaviour. A comparison of theoretical results with experimental data showed that the axial-vector coupling constant is not renormalized by nuclear media in medium-weight nu-

clei, whereas such a renormalization seems to be necessary to explain the data in heavy-mass nuclei [21].

The effect of the width of levels on the level mixing was studied for a system of two discrete levels coupled to continuum. It was shown that the resulting decay widths of the mixing levels have a characteristic energy behaviour depending on a position of the discrete levels with respect to the channel threshold. The result is important for understanding of a structure of very weakly bound nuclei, where the interaction of the bound and unbound levels appears to be pronounced [22].

The angular momenta of fission fragments were calculated under the assumption that the bending angular vibrations in a pre-scission system are responsible for a generation of angular momenta of the fragments. The calculated results are in qualitative agreement with the experimental data for the ^{252}Cf spontaneous fission [23].

The general formalism of describing a nonlinear evolution of a nuclear surface without usual additional assumptions about a shape of a nuclear system was suggested. Due to the formalism the application of methods of differential geometry to analyze an evolution of an axisymmetric nuclear surface becomes possible [24].

The methods of nuclear structure theory were applied to *physics of metal clusters*.

A consistent factorization of the two-body residual interaction in the framework of random phase approximation was proposed to study multipole electric oscillations of valence electrons in deformed alkali metal clusters. Both the deformed mean field and residual interaction were derived self-consistently from the Kohn–Sham functional. In clusters with the number of atoms $N > 50$, the Landau damping competes with the deformation splitting and becomes decisive in forming the width and gross structure of the dipole plasmon [25].

A semiclassical analysis of the lowest-order multipole deformations of simple metal clusters was performed. The self-consistent mean field of the valence electrons is modelled by an axially deformed cavity and the oscillating part of the total energy was calculated semiclassically using the shortest periodic orbits. Good qualitative agreement is obtained with the results of quantum-mechanical calculations using the shell-correction method [26].

The results within the project *Few-Body Physics* are the following:

The Faddeev equations with S -wave two-body interactions of centrifugal type were analyzed. The criterion was proved for the existence of exact solutions which are the product of the Bessel function of the hyperradius and a linear combination of the three-particle hyperharmonics with the searched numerical coefficients. The construction of the exact solutions was reduced to the analysis of the algebraic systems. The first deduction of that analysis was the proof of the existence of special

three-body configurations. In these configurations any two or all the three particles do not collapse, although the sufficient condition for collapse of two particles in the absence of the third one is fulfilled [27].

Neutral pion photo- and electroproduction at the threshold was analyzed in the framework of dispersion relations. To this aim, the real threshold amplitudes in terms of Born contributions as well as dispersion integrals determined by the imaginary parts of the multipoles of the unitary isobar model and the phenomenological partial-wave analysis were evaluated. Considerable cancellations between Born terms and resonance contributions were found. Good agreement with the data was found for photoproduction, whereas the dispersion analysis suggested considerable discrepancies for electroproduction [28].

The non-self-adjoint operators were constructed which factorize the transfer function associated with a self-adjoint 2×2 matrix Hamiltonian whose diagonal entries can have overlapping spectra and whose off-diagonal entries are unbounded operators. In particular, it was proved that the complex eigenvalues of these non-self-adjoint operators represent the resonances of the initial spectral problem [29].

The process of coherent photoproduction of η mesons on light nuclei was investigated on the basis of a microscopic finite-rank approximation method. A series of numerical results was obtained in the case of the ^3He and ^3H targets and various inputs for η -nucleon interactions [30].

The main results of the project *Relativistic Nuclear Dynamics* are:

The new theoretical model was developed to study the ω -meson photoproduction by taking into account all the known baryon resonances listed in Particle Data Group, and other mechanisms of photoproduction. The theoretical problem of self-consistent description of the high-spin resonances and their interactions with mesons and nucleons was solved. The model opens a possibility of calculating unpolarized observables and all the spin correlations [31].

The charge exchange and break-up reactions $pD \rightarrow n(pp)$ and $pD \rightarrow (pp)n$ at high energies were studied within the Bethe–Salpeter formalism. The final state interaction in the detected pp pair was described by the S^{++} and P^{+-} components of the 1S_0 Bethe–Salpeter amplitude. The results of numerical calculations showed that the negative P components can play a crucial role in describing the cross section at kinematical conditions corresponding to the node of the nonrelativistic 1S_0 wave function of the pp pair [32].

The dispersion relations for the nucleon–nucleon T -matrix in the framework of the Bethe–Salpeter equation for a two spin-one-half particle system with a separable kernel of interaction were considered. The derived expressions allowed one to find an explicit analytic connection between the parameters of the separable kernel and the low-energy scattering parameters, as well as

the deuteron binding energy, and to construct the rank-I separable kernel of interaction for S -partial waves in singlet and triplet channels. The phase shifts were calculated. The approach can be extended to higher partial waves for NN scattering and other reactions [33].

Form factors of ^{12}C were investigated within different approaches with the aim of analyzing the alpha-clusterization and short-range correlations in light nuclei. Two methods were applied: the ordinary Born approximation and a numerical solving of the Dirac equation. It was shown that at large transfer momenta a considerable difference took place between the results of the two methods. Thus, only the numerical solving of the Dirac equation can reveal the structure effects due to the short- and middle-range nucleon correlations in nuclei [34].

THEORY OF CONDENSED MATTER

Theoretical investigations in the Theory of Condensed Matter were continued in the framework of the following projects:

- Strongly correlated systems;
- Dynamical systems: chaos, integrability, and self-organization;
- Disordered structures: glasses, topological defects, nanostructures and the Josephson junction;
- Mesoscopic and coherent phenomena in quantum systems.

A theoretical model involving a nonstandard mechanism of superexchange interaction of magnetic ions in a new layered manganite crystal $A_2\text{MnGaO}_{5+\delta}$ ($A = \text{Sr}, \text{Ca}$) was formulated and developed. A strong relation between the crystal structure modifications and the magnetic ground state observed in neutron-scattering experiments recently performed at JINR's FLNP was explained [36].

Thermoelectric properties of various strongly correlated materials with d - and f -shell electrons were explained within the dynamical mean field theory where the quantum Monte-Carlo method was used to solve the impurity model [37].

An intriguing doping dependence of the exchange energies in the bilayer manganites observed recently in neutron-scattering experiments was explained within a two-orbital electronic model with strong Coulomb repulsion and Jahn–Teller interaction, as caused by the orbital level splitting dependence on the doping [38].

For the free models of statistical mechanics on torus, exact asymptotic expansions of the free energy, the internal energy, and the specific heat in the vicinity of the critical point were found. It was shown that there was a direct relation between the terms of the expansion and the Kronecker double series. The latter can be

Moreover, new results were also obtained in *the Vavilov–Cherenkov radiation theory*.

The charge motion in medium on a finite space interval was considered. Exact solution of the Tamm problem in the time representation showed that in some time interval, only the bremsstrahlung shock waves associated with the beginning of motion and the Cherenkov shock wave exist. The radiation produced by a charge motion consisting of accelerated, decelerated and uniform parts was studied in the spectral representation. It was proved that in the original Tamm problem the instantaneous acceleration and deceleration do not contribute to the radiation intensity. The results obtained may be applied to various physical problems including decelerated heavy ion motion in transparent media [35].

expressed in terms of the elliptic theta functions in all orders of the asymptotic expansion [39].

An eigenvalue problem was considered which includes a nonlinear Schrödinger equation on the half-line $[0, \infty)$ and certain boundary conditions. It was shown that the spectrum of this problem fills a half-line and each point of the spectrum has a unique corresponding eigenfunction. The main result is that an arbitrary differentiable function $g(x)$ rapidly decaying as $x \rightarrow \infty$ and satisfying suitable boundary conditions at the point $x = 0$ can be uniquely expanded into an integral over eigenfunctions by the Fourier transform [40].

Several novel phenomena in a twisted superconductor (containing a small annular SIS -type contact) under the influence of thermal gradient and applied magnetic field were predicted, including a torsional analog of Josephson piezomagnetism and magnetomechanical effect. A giant enhancement (reaching 500%) of electronic contribution to the thermal conductivity of a granular superconductor in applied electric field was predicted within the model of inductive Josephson junction arrays [41].

The peculiarities of phonon scattering by static strain fields due to circular wedge disclination loops were established within the deformation-potential approach [42].

Within the heterogeneous string model a contribution of twist disclinations to the specific heat and internal friction of disordered semiconductors was calculated [43].

The density of electronic states near disclinations was calculated for three geometries: sphere, cone, and hyperboloid. It was found that for π disclination a region of nonzero density of states across the Fermi level was formed [44].

The dependence of the MgB₂ superconducting critical temperature on the pressure was calculated by taking into account the influence of large polarons on the band structure of the material. The obtained result is in reasonable agreement with experiments [45].

The kinetic and interaction energies of a three-dimensional (3D) dilute ground-state Bose gas confined in a trap were calculated beyond the mean-field arguments. These energies are found to depend on the form of the pairwise interaction potential, which indicates the appearance of a new positive characteristic length b in addition to the well-known scattering length a [46].

The method of stability indices was suggested for description of the stability of stochastic systems. It was shown that quasi-isolated systems are stochastically unstable [47].

COMPUTER FACILITIES

The Sun Blade 1000 workstation, equipped with two UltraSPARC III processors, 1.5 GB RAM and Solaris 9, was installed in the computer hall. The operating systems of the old Sun Microsystems computers were upgraded to Solaris 9 or Solaris 8. A big bunch of utilities and freeware applications were renewed.

The new computational server based on two Pentium 4 Xeon operating at 2.2 GHz was installed (<http://thsun1.jinr.ru/guide/up4m/>). The server is equipped with 2 GB of RDRAM and running under Linux Debian 3. The performance of the new server considerably exceeds the performance of the other servers at BLTP.

To improve administration of large and heterogeneous Unix cluster at BLTP, the protocol LDAP (Lightweight Directory Access Protocol) over SSL (Secure Sockets Layer) was introduced. This protocol allows one to authenticate users on any server taking data from single database.

The network printer in the KRAST hall was replaced by the new one with a higher performance and duplex printing capability.

MEETINGS, SCIENTIFIC COLLABORATION

In 2002, the Laboratory participated in 11 international conferences, workshops and schools held in Dubna, Prague, High Tatras, Hessen and Alushta.

The 5th international conference «Renormalization Group 2002» was held in a picturesque place Tatrana

In many sciences (physics, chemistry, biology, sociology) there are problems of describing the kinetics of creation and decay of some compound objects. A stochastic approach was developed which is based on the assumption about rates of transition intensities between the states with given generations numbers. In such an approach, the processes of aggregations and fragmentations were simultaneously described for the first time [48].

It was shown that realistic quantum teleportation appears to be not only state-dependent, but also dependent on the position of the source of entanglement relative to the sending and receiving stations in view of essential degradation of the amount of quantum mechanically transferable information [49].

Twenty-three modern personal computers were installed in 2002 at BLTP. Most of the computers are equipped with Pentium 4 1.8–2.0 GHz, 512 MB DDR RAM, 40 GB HDD, CD-RW.

The installation of the cabling system based on UTP was completed. The new network spans all offices at BLTP and provides at least two Fast Ethernet sockets at each location. The stack of network switches has grown up. The total number of Fast Ethernet ports reached 200. By the end of 2002, about 140 personal computers and servers were connected to the new networking equipment. The introduction of Gigabit Ethernet was started in a group of servers. To improve the network management and for users' convenience, the protocol DHCP (Dynamic Host Configuration Protocol) was introduced. This allows setting the networking parameters at any PC in the local network.

At proxy and file server thproxy.jinr.ru, the disk space and amount of memory were extended. The file archive was transferred to RAID-5 disk array. For faster operation, the search engines were moved from thsun1.jinr.ru to thproxy.jinr.ru. This work was funded by RFBR (the Russian Foundation for Basic Research).

ska Štrba (High Tatra Mountains, Slovakia) on 10–16 March. Conferences devoted to application of the renormalization-group methods in various fields of theoretical physics have been organized on the initiative of D. V. Shirkov since 1986. The first three conferences

were held in Dubna (1986, 1991, 1996); the fourth one, in Mexico (1999). The fifth conference was organized by the Institute of Experimental Physics of the Slovak Academy of Sciences and the Bogoliubov Laboratory of Theoretical Physics. Its programme covered a wide spectrum of approaches to the renormalization group and their applications in quantum field theory, statistical physics, stochastic and nonlinear dynamics, mathematical physics. At the conference, the scientists of JINR delivered eight reports.

International School on Heavy Quark Physics took place at the Bogoliubov Laboratory of Theoretical Physics on 27 May – 5 June. About fifty students and lecturers from Great Britain, Germany, Italy, Russia, the Ukraine, the USA and Croatia participated in the school. The school was devoted to one of the hot topics in elementary particle physics — physics of hadrons composed of heavy quarks. A comprehensive review of the most interesting problems (production and decays of heavy hadrons, CP violation) and the modern methods and models for their investigation (effective field theories, Schwinger–Dyson equations, lattice QCD) has been given. A modern status of investigations conducted by the leading experimental groups was covered in the reports of representatives of the collaborations Hera-B, BaBar and Belle. The school continued a series of workshops «Heavy Quark Physics» held in Dubna (1993, 1996, 2000), Bad Honnef (1994) and Rostock (1997), but this time the participation of diploma and PhD students as well as young researchers received much attention. Besides the attendance of the lecture courses, students had an opportunity to present their own original results during the seminars within the school schedule. The infrastructure of the Joint Institute for Nuclear Research and the Laboratory of Theoretical Physics as well as the support of the BMBF (Germany) and RFBR (Russia) strongly facilitated the organization of the school.

On 21 July – 30 August, the DAAD summer school «Quantum Statistics of Many-Particle Systems» was held in Dubna. It was the second school supported by the Federal Ministry of Education, Research and Technologies and Deutscher Akademischer Austauschdienst (DAAD). Forty-three students from 9 countries, including 18 from Russia and 15 from Germany, as well as from Armenia, Belarus, Egypt, Hungary, Japan, Korea, and Poland took part in the school. Lecturers of the school were the famous scientists from Armenia, Germany, France, Italy, Japan, Russia, the Ukraine, and the USA. The programme was more interesting and wider this year and included lectures on quantum fields at finite temperature and density; Green functions in equilibrium and nonequilibrium thermodynamics; density functional theory; bound states and clusters; phase transitions in heavy-ion collisions; Monte-Carlo simulations of Coulomb systems; dense matter in compact stars and supernova. The School Proceedings will be published by the Springer-Verlag Publishing House. Next school

within this programme to be held in Dubna in the summer of 2003 will be on the rapidly developing subject «Econophysics and Traffic».

In 2002, the regular workshops organized by the Laboratory: «Nucleation Theory and Applications», (4–28 April); «Quantum Gravity and Superstrings», (11–18 July) were successfully held. The workshops were supported by UNESCO (UVO ROSTE), the Russian Foundation for Basic Research, the Heisenberg–Landau programme, and the Bogoliubov–Infeld programme.

The Laboratory participated in the organization of a number of meetings: international workshop «New Models and Nuclear Methods in Biophysics and Biochemistry» (24–26 January, Dubna); XVI International Baldin Seminar on High Energy Physics Problems (10–15 June, Dubna); international colloquium «Quantum Groups and Integrable Systems» (20–22 June, Prague, the Czech Republic); international workshop and school «Symmetries and Spin» (14–28 July, Prague, the Czech Republic); International Symposium on Nuclear Clusters (5–9 August, Hessen, Germany) and XXXII international symposium «Multiparticle Dynamics» (7–13 September, Alushta, the Ukraine).

In 2002, the international collaboration was supported by grants of the Plenipotentiaries of Bulgaria, the Czech Republic, Poland, the Slovak Republic, Hungary, Romania and the JINR Directorate; the collaboration with German theorists was based on the Heisenberg–Landau programme; with Polish theorists, on the Bogoliubov–Infeld programme; and with Czech theorists, on the Blokhintsev–Votruba programme.

Some studies were carried out in collaboration with scientists from Western Europe in the framework of the JINR–INFN, JINR–IN2P3 agreements and on the projects supported by INTAS, RFBR–DFG, RFBR–CNRS.

The agreements for collaboration between the Bogoliubov Laboratory and CERN TH, ICTP are functioning.

REFERENCES

1. *Bandos I., Ivanov E., Lukierski J., Sorokin D.* // JHEP. 2002. V.0206. P.040.
2. *Kadyshevsky V. G., Sorin A. S.* // Teor. Mat. Fiz. 2002. V.132. P.222.
3. *Lechtenfeld O., Popov A. D., Uhlmann S.* // Nucl. Phys. B. 2002. V.637. P.119–142.
4. *Pakulyak S., Sergeev S.* nlin.SI/0209019; Teor. Mat. Fiz. (in press).
5. *von Gehlen G., Pakuliak S., Sergeev S.* nlin.SI/0208035; Phys. A: Math. Gen. (in press).
6. *Filippov A. T., Maison D.* Preprint MPI-PhT 2002-61; gr-qc/0210081.

7. *Shirkov D. V.* hep-th/0210013; *Teor. Mat. Fiz.* (submitted).
8. *de Boer W. et al.* // *Nucl. Phys. Proc. Suppl.* 2002. V. 113. P. 221.
9. *Efremov A. V., Goeke K., Schweitzer P.* // *Eur. Phys. J. C.* 2002. V. 24. P. 407; hep-ph/0208124.
10. *Bakulev A. P., Mikhailov S. V.* // *Phys. Rev. D.* 2002. V. 65. P. 114511(14).
11. *Kuraev E., Galynsky M., Ilichev A.* // *JETP Lett.* (in press).
12. *Bytev V., Kuraev E., Baratt A., Thompson J.* // *Eur. Phys J. C.* (in press).
13. *Manjavidze I. D., Sissakian A. N.* // *Teor. Mat. Fiz.* 2002. V. 130. P. 153.; Mini-rapporteur report, ICHEP-31, Amsterdam, 2002; *Sissakian A. N.* // *UFN* (in press).
14. *Surovtsev Yu. S., Krupa D., Nagy M.* // *Eur. Phys. J. A.* 2002. V. 15.
15. *Dorokhov A. E., Cherednikov I. O.* // *Phys. Rev. D.* 2002. V. 66. P. 074009.
16. *Dorokhov A. E., Volkov M. K., Yudichev V. L.* hep-ph/0203136; *Yad. Fiz.* 2003. V. 66(3) (in press).
17. *Bilenky S. M. et al.* // *Phys. Lett. B.* 2002. V. 533. P. 191–195.
18. *Pervushin V. N., Proskurin D. V., Gusev A. A.* // *Gravitation & Cosmology.* 2002. V. 8. P. 181.
19. *Behnke D. et al.* // *Phys. Lett. B.* 2002. V. 530. P. 20.
20. *Severyukhin A. P. et al.* // *Phys. Rev. C.* 2002. V. 66. P. 034304.
21. *Kuz'min V. A. et al.* // *J. Phys. G: Nucl. Part. Phys.* 2002. V. 28. P. 665.
22. *von Brentano P., Jolos R. V., Weidenmuller H. A.* // *Phys. Lett. B.* 2002. V. 534. P. 63.
23. *Schneidman T. M., Adamian G. G., Antonenko N. V., Ivanova S. P. et al.* // *Phys. Rev. C.* 2002. V. 65. P. 064302.
24. *Kartavenko V. G., Gridnev K. A., Greiner W.* // *Yad. Fiz.* 2002. V. 65. P. 637.
25. *Kleinig W., Nesterenko V. O., Reinhard P.-G.* // *Annals Phys. (N. Y.)* 2002. V. 297. P. 1.
26. *Pashkevich V. V. et al.* // *Phys. Lett. A.* 2002. V. 294. P. 314.
27. *Pupyshev V. V.* // *Phys. Part. Nucl.* 2002. V. 33. P. 435.
28. *Kamalov S. S. et al.* // *Phys. Rev. C.* 2002. V. 66. P. 065206.
29. *Hardt V., Mennicken R., Motovilov A. K.* // *J. Operator Theory.* 2002. V. 48. P. 187.
30. *Shevchenko N. V. et al.* // *Nucl. Phys. A.* 2002. V. 699. P. 165.
31. *Titov A. I., Lee T.-S. H.* // *Phys. Rev. C.* 2002. V. 66. P. 015204.
32. *Dorkin S. M. et al.* // *Yad. Fiz.* 2002. V. 65. P. 469.
33. *Bondarenko S. G. et al.* // *Phys. Rev. C.* 2002. V. 65. P. 064003.
34. *Lukyanov V. K. et al.* // *Part. Nucl., Lett.* 2002. No. 2 [111]. P. 6.
35. *Afanasiev G. N., Shilov V. M.* // *J. Phys. D: Appl. Phys.* 2002. V. 35. P. 854.
36. *Pomjakushin V. et al.* // *Phys. Rev. B.* 2002. V. 66. P. 184412.
37. *Oudovenko V. S., Kotliar G.* // *Phys. Rev. B.* 2002. V. 65. P. 075102.
38. *Jackeli G., Perkins N. B.* // *Phys. Rev. B.* 2002. V. 65. P. 212402.
39. *Ivashkevich E. V., Izmailian N. Sh., Chin-Kun Hu* // *J. Phys. A: Math. Gen.* 2002. V. 35. P. 5543.
40. *Zhidkov P. E.* // *Diff. Uravneniya.* 2002. V. 38. P. 1183.
41. *Sergeenkov S.* // *JETP Lett.* 2002. V. 75. P. 388; V. 76. P. 204.
42. *Krasavin S. E., Osipov V. A.* // *J. Phys.: Cond. Mat.* 2002. V. 14. P. 12923.
43. *Churochkin D. V., Osipov V. A.* // *J. Phys.: Cond. Mat.* 2002. V. 14. P. 12917.
44. *Osipov V. A., Kochetov E. A., Pudlak M.* // *ZhETF* (in press).
45. *Ivanov V. A., Smondyrev M. A., Devreese J. T.* // *Phys. Rev. B.* 2002. V. 66. P. 134519.
46. *Cherny A., Shanenko A.* // *Phys. Lett. A.* 2002. V. 293. P. 287.
47. *Yukalov V. I.* // *Phys. Rev. E.* 2002. V. 65. P. 056118.
48. *Dubovik V. M. et al.* // *Phys. Rev. E.* 2002. V. 66. P. 0161106.
49. *Chizhov A. V., Knöll L., Welsch D.-G.* // *Phys. Rev. A.* 2002. V. 65. P. 022310.

VEKSLER AND BALDIN LABORATORY OF HIGH ENERGIES

The scientific programme of theoretical and experimental activities of the Veksler and Baldin Laboratory of High Energies (VBLHE) in the field of Relativistic Nuclear Physics is aimed at preparing and carrying out experiments that significantly influence further development of the strong interaction theory and modern theory of the atomic nucleus. The interaction between relativistic nuclei in the energy range from several hundred MeV to several TeV per nucleon is studied to search for manifestations of quark–gluon degrees of freedom in nuclei and asymptotic laws for the nuclear matter. Another research subject is the spin structure of the lightest nuclei. In particular, the programme envisages obtaining new information on the properties of the processes of multiple particle production in collisions of different nuclei, and studying the properties of strongly interacting matter at the extreme energy density and in the transition area from hadronic matter to quark–gluon plasma. The search for and study of the properties of strongly excited nuclear matter will allow one to verify the QCD theory and to obtain possible answers to the following fundamental questions: What is confinement? What are the mechanisms of hadronization and chiral symmetry violation?

Research is carried out at the VBLHE accelerator complex and at other accelerator centres, including CERN, BNL, GSI, RIKEN, Uppsala, and others.

A number of research facilities are in operation at the VBLHE accelerator complex, including SPHERE, GIBS, FASA, DELTA–SIGMA, DELTA, DISK, SMS, MARUSYA, SKAN-1, SKAN-2, STRELA, and others. Further development of the existing research facilities and creation of new ones (SINGLET, NIS, etc.) are planned. Major contributions are made to the design of other research centres' experimental facilities, including NA45, NA49, STAR, PHENIX, CMS, ALICE, HADES, WASA, and others.

The VBLHE accelerator complex includes the old machine, the Synchrotron, and a new superconducting accelerator, the Nuclotron. During several years the VBLHE research programme has been performed mostly at the Nuclotron. The Nuclotron is based on the unique technology of the superconducting magnetic system, which was proposed and investigated at the Laboratory [1].

On the basis of the Nuclotron, a user's centre is being created for relativistic nuclear physics research and for solving applied problems by using relativistic ions in the energy range of several GeV per nucleon.

The technologies of producing prototypes of fast-cycling superconducting magnets will be developed further. The Nuclotron-type magnets are planned for the future superconducting accelerator in Darmstadt.

Some new results obtained at the Acceleration Complex of VBLHE in previous runs were published in [2].

DEVELOPMENT OF THE ACCELERATOR COMPLEX

During 2002 the Laboratory had three Nuclotron runs of a total of 1850 hours. In the March run the intensity of the external beam of magnesium ions was increased up to $\approx 10^8$. The summer run of the Nuclotron

accelerated the ions of argon for the first time with an intensity of $1.4 \cdot 10^6$ and $E_K \approx 1 \div 2$ GeV/nucleon. In December the polarized deuteron beam was accelerated and extracted from the Nuclotron with an energy

of more than 2 GeV/nucleon and a beam intensity of $1.8 \cdot 10^8$ particles per cycle. The vector polarization measured in the ring and point F3 at energies in the range of $1 \div 2$ GeV/nucleon was 0.57–0.60. The polarization coefficient of the extracted beam corresponded to the coefficient of the polarization of the beam injected

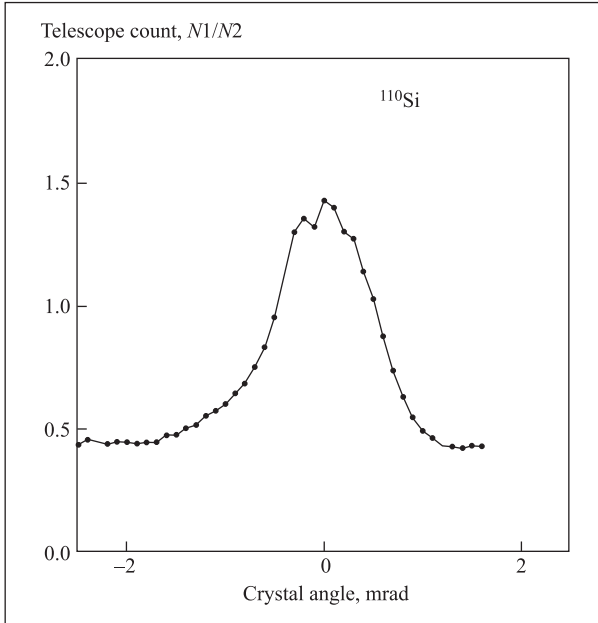

Fig. 1. The dependence of the count ratio for the scintillation telescope installed along the deflected beam path and the background telescope on the crystal angle with the beam (for protons with a momentum of 5 GeV/c and a silicon crystal with the length of 1 cm and a bending angle of 28 mrad)

into the ring of the Nuclotron. The duration of stretching of the extracted beam was increased up to 2 s.

The first experiments were performed on the crystal deflectors at the external beam of the Nuclotron (De-

EXPERIMENTS AT THE NUCLOTRON BEAM

In 2002 the external and internal beams of the Nuclotron were used for investigations of the physical groups. The final calibration of the equipment was carried out at this beam for the joint experiment PAMELA (Italy–Russia) [6]. In March the ^{24}Mg beam was used by the Italian group for the PAMELA collaboration.

In 2001 the DELTA–SIGMA group acquired the experimental data on total np cross-section difference $\Delta\sigma_L(np)$ measurements, with both parallel and antiparallel longitudinal orientations of neutron and proton spins, at four kinetic energies near $T_n = 1.8$ GeV

center run). The beam of 5-GeV/c protons and few silicon deflectors were used. The experiment purpose was to test a new goniometer device and a registration system to fulfil the investigation programme with tungsten crystals, which possess stronger inner fields than silicon crystals. Two scintillation telescopes symmetrically installed relative to the external beam and ZnS screen with an electron-optical image amplifier were used to register the beam deflected by the crystal. The dependence of a deflected particle number on the orientation angle of crystals with bending angles of 28, 32 and 55 mrad was obtained (see Fig. 1). The width of the dependence at half height is about 1 mrad and is determined by the angular beam width. The part of the beam deflected is about 10^{-5} . The deflected beam image could be observed with a removal monitor. The preparative work was made to perform the investigation of parametric X-radiation from nuclei in a crystal. This radiation arises due to diffraction of the electromagnetic field of relativistic particles in a crystal [3, 4].

The application of the new generation of the wet turboexpanders has increased the efficiency of the helium refrigerators of the Nuclotron by more than 25% [5].

The Synchrotron enjoyed the run in November 2002. Simultaneously, in the framework of one experiment (MSU–SPHERE) the damping of the analyzing power of the nucleon–nucleon interaction at scattering by the inner nuclear nucleons was measured for the first time on the beam of stripping polarized protons. A preliminary analysis of the obtained data has shown that the damping of the analyzing power for scattering by protons and neutrons at the investigated energies on nuclei of carbon and copper practically coincides.

The SPHERE set-up has fulfilled data taking on the tensor analyzing power A_{yy} for the momenta of cumulative π^- 1.45, 1.6, 1.8, 2.0 and 2.1 GeV/c at the angles of pion emission equal to 0 and 180 mrad.

with a statistical accuracy of ~ 1 mb. In 2002 the results of processing and analysis (see Fig. 2) of these new data at 1.4, 1.7, 1.9 and 2.0 GeV from the DELTA–SIGMA set-up were presented at symposiums in Dubna, Prague, Brookhaven and at an RAS nuclear physics division session, along with our previously acquired and published $\Delta\sigma_L(np)$ data for six energies (in the $1.2 \leq T_n \leq 3.7$ GeV range) of polarized quasi-monochromatic neutron beam.

The DELTA–SIGMA group has designed, constructed and started to use the $np \rightarrow pn$ charge-

exchange protons tracking system to conduct (with the unique quasi-monochromatic neutron beam simultaneously with $\Delta\sigma_{L/T}$ measurements) the complete experiment of A_{00kk}/A_{00nn} spin correlation coefficients measurements in np charge exchange at 0° lab. sys. (that corresponds to $np \rightarrow pn$ backward scattering to 180° at c. m. s.). Using this system of multiwire proportional chambers (1000 channels) as part of the magnetic spectrometer, the group achieved optimum separation of momentum peak of $np \rightarrow pn$ charge exchange at $T_n = 1.3, 1.5$ GeV. Simultaneously with these $np \rightarrow pn$ charge-exchange measurements at 0° by using the upgraded spectrometer, total np cross sections at $T_n = 1.3, 1.5$ GeV were successfully measured with the intense non-polarized n beam from the Nuclotron, using the same (as in $\Delta\sigma_L(np)$ experiments) transmission technique and the equipment, including the same neutron detectors $M_{1,2}, T_{1,2,3}$.

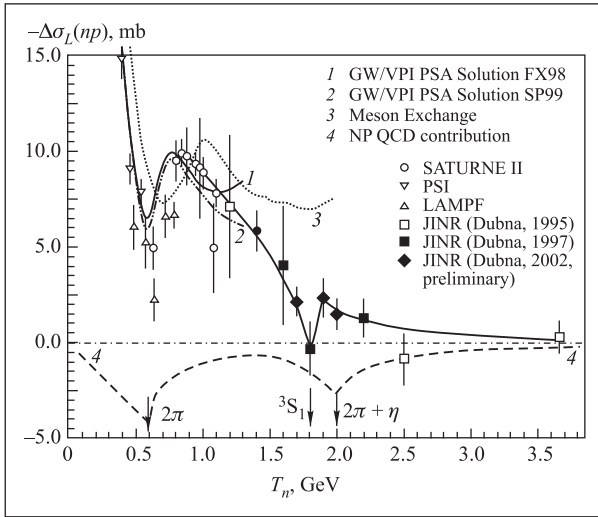

Fig. 2. Energy dependence of the $\Delta\sigma_L(np)$ observables obtained with the polarized neutron beam

For these methodical and physical measurements with the n beam of 1B channel at VBLHE building 205, a special cryogenic target filled with liquid H_2 or D_2 was prepared. In order to use the H_2/D_2 target in the experimental set-up, the polarized target PPT placed on a moveable platform was removed transversely to the n beam and replaced by the H_2/D_2 target. The np charge-exchange cross sections were also measured at 0° using the P and D targets at $T_n = 1.4$ GeV. This allows the group to determine the spin-flip mechanism contribution to $np \rightarrow pn$ charge exchange at 0° when using the nonpolarized beam and nonpolarized target as the $nd \rightarrow p(nn)$ charge exchange takes place only owing to np amplitudes with spin-flip (Pomeranchuk I. Ya. et al., 1951). Continuation of such pilot measurements at $T_n = 1 \div 3$ GeV, planned for February 2003, firstly, will allow one to optimize research of the anomaly of energy dependence $\Delta\sigma_L(np)$ near $T_n = 1.8$ GeV. Secondly, it will give an opportunity to optimize the set of np

spin observables $\Delta\sigma_{L/T}(np)$ and A_{00kk}/A_{00nn} measurements (planned for 2003) over the $T_n = 1 \div 3.6$ GeV energy range, for which the np phase shift analysis is absent.

At the MARUSYA set-up the research with the use of an internal target and external beam is continued. In a June session of the Nuclotron, the adjustment magneto-optical system spectrometer was carried out, and the spectra of pions, protons, and deuterons were obtained.

^{10}B nuclei were accelerated at the Nuclotron, and the ^{10}B nucleus beam of an energy of $1 A \cdot GeV$ was formed. The beam was used to irradiate stacks composed of BR-2 type emulsion layers $550 \mu m$ thick and measuring 10×20 cm, which were sensitive to minimum ionization of single-charged particles. During irradiation, the emulsion layers were located parallel to the beam direction so that the beam particles could enter the butt-end of the emulsion layers. Information about the charge composition of charged fragments and about the channels of ^{10}B -nucleus fragmentation in peripheral collisions has been obtained. We attribute to the peripheral interactions the events in which the total charge of relativistic fragments is equal to the charge of the primary ^{10}B nucleus, the production of charged mesons is not observed, but the production of slow nuclear fragments can occur. In 65% of these peripheral interactions the ^{10}B nucleus is disintegrated to two double-charged and one single-charged particles. A single-charged particle is the deuteron in 40% of these events. Ten per cent of the events contain fragments with a charge equal to 3 and 2 (Li and He isotopes), and 2% of the events contain a fragment with charges equal to 4 and 1 (Be nucleus and the proton). The 6Li production accompanied by an α particle may be considered as a correlation of α particle and deuteron clusters. The photography has shown an example of a two-particle decay to Li and He fragments. The fragmentation channel containing α particle and three single-charged fragments (disintegration of one of the α clusters) makes up 15%.

An equal correlation of the channels $(2He + d)/(2He + p) \approx 1$ is analogous to the 6Li fragmentation, where $(He + d)/(He + p) \approx 1$. These ratios point to an abundant yield of deuterons in the ^{10}B case, too [2, 3]. Thus, the deuteron cluster manifests itself directly in the three-particle decays of ^{10}B nuclei accompanied by two double-charged particles. Another indication of deuteron clustering is a small mean transverse momentum of deuterons $P_t = 0.14 \pm 0.01$ GeV/c in these events, just the same way as in the case of 6Li , where $P_t = 0.13 \pm 0.02$ GeV/c.

The use of emulsions seems to be mostly justified at relativistic radioactive nucleus beams in the domain of light neutron-deficient isotopes. Thanks to the most complete observation, the most significant decay channels for excited nuclei can be established by the charge

of the final states. For these channels, it is possible to analyze the mass and angular spectra, to look into the correlations and to estimate specific excitation energies.

As the first step along these lines, the group has performed irradiation of emulsions at the Nuclotron. A secondary beam containing a large fraction of ${}^7\text{Be}$ nuclei was used. The beam was formed by tuning a magnet-optical channel for optimum choice of the products of accelerated ${}^7\text{Li}$ and ${}^7\text{Be}$ charge-exchange reaction. The cross section of this reaction is of the order of 10^{-4} of the inelastic cross section. At present, the obtained results are analyzed.

The goal of the SCAN-2 experiment is to study the fragmentation of the deuterium nuclei in the production of two co-linear protons. Kinematically, this reaction is analogous to the elastic scattering of the deuterium nuclei to an angle of 180 degrees by the proton. But an additional condition — recharging of neutron into proton — results in essential redistribution of the reaction channels to the final result. The goal of the run in December, 2002, was to measure the cross section at two momenta of the colliding deuterons of 3 and 4 GeV/c.

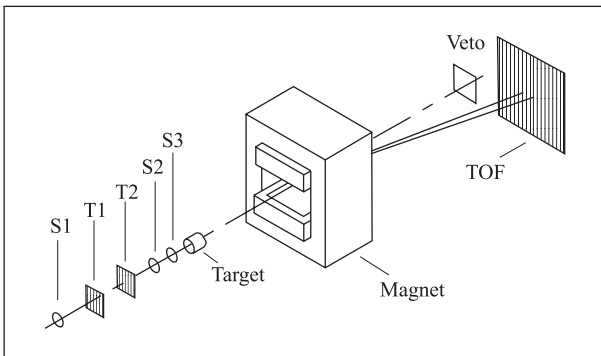

Fig. 3. A schematic view of the spectrometer SCAN-2

A schematic view of the spectrometer is shown in Fig. 3. It includes monitor detectors S1–S3, a vertex coordinate system T1–T2, an analyzing dipole magnet and a hodoscopic 32-channel system to register the time and coordinate information.

The deuteron beam with a pulse of 3.5 GeV/c has carried out a probe measurement of the products of the reaction $d + p \rightarrow (pp) + n$ by using the solid polyethylene and carbon targets. The measurements have shown a possibility of extracting the events necessary for us by using the time-of-flight technique. Figure 4 illustrates the time spectrum registered during the exposition of the polyethylene target. The spectrum vividly shows separable peaks of different processes. The left peak is a stripping proton from the deuteron destruction, the middle peak — a recoil proton from quasi-elastic scattering of the deuteron proton, and the right peak is the reaction under consideration — elastic scattering of deuteron back with the recharging of neutron into pro-

ton. The result of recharging is two protons with equal momenta and flight angles.

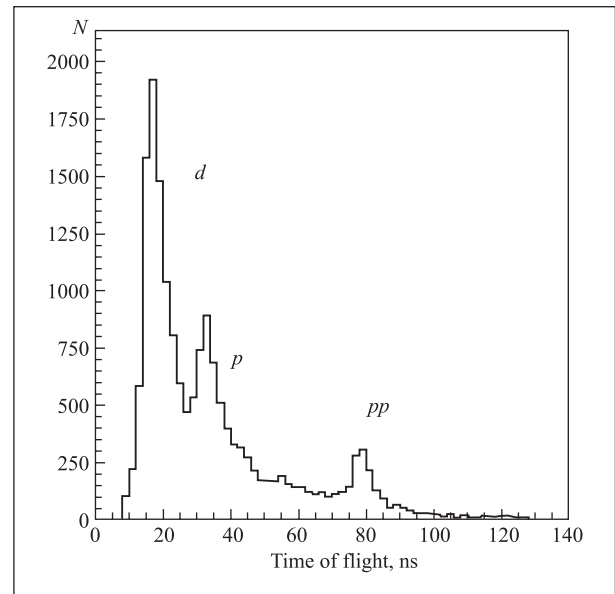

Fig. 4. The time spectrum recorded during the exposition of the polyethylene target. Peaks of different processes are very clearly separable on the spectrum

To measure the degree of the beam polarization, a specialized polarimeter was manufactured in the Nuclotron, which uses the inner target of the Nuclotron. This choice is explained by the following factors:

- multiple passing of the beam through the target is used, which allows one to apply very thin targets without losses of the luminosity and to reduce probability of multiple interaction and multifold scattering of the secondary particles in the substance of the target;
- primary impulse is permanent;
- the time of measuring can be changed in a wide range from shares of second till several minutes.

The experimental set-up included a remote-controlled target station (polyethylene and carbon targets) and four scintillation telescopes. The basis of the apparatus consisted of two monitor telescopes F_l and F_r of the SCAN spectrometer installed at an angle of 14 degrees to the right and to the left from the ionguide of the accelerator (see Fig. 5). To extract the recoil protons, the set-up was completed with two telescopes B_l and B_r , which were placed at an angle of ± 68 degrees and had two scintillation counters each. The angles of 14 and 68° were chosen due to the kinematic parameters of the reaction of the quasi-elastic pp scattering, when the analyzing power is maximal. The general position of the polarimeter is shown in Fig. 5.

A polyethylene film, 10 μm thick, 2 mm wide, was taken as a hydrogen-containing target. The second target consisted of 10 carbon threads, 8 μm in diameter, placed in a row. In the December run of 2002

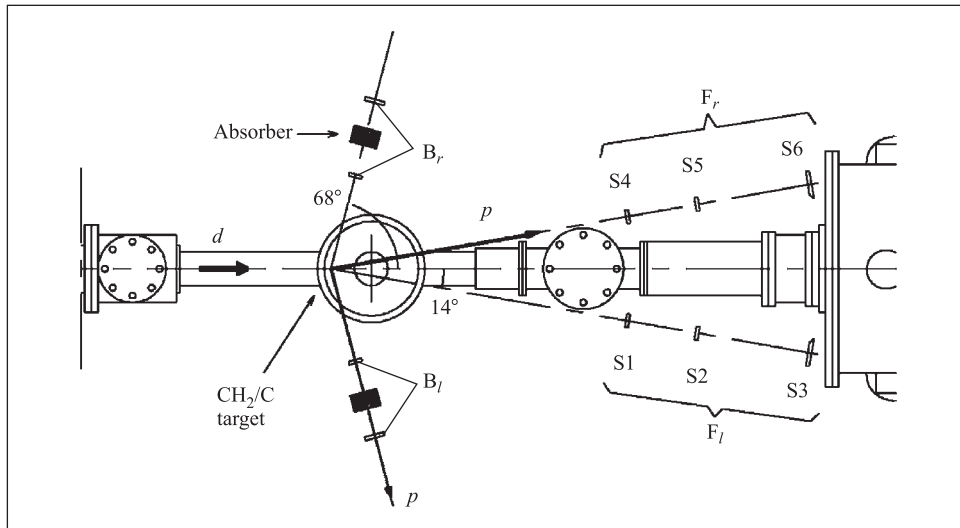

Fig. 5. A scheme of the polarimeter

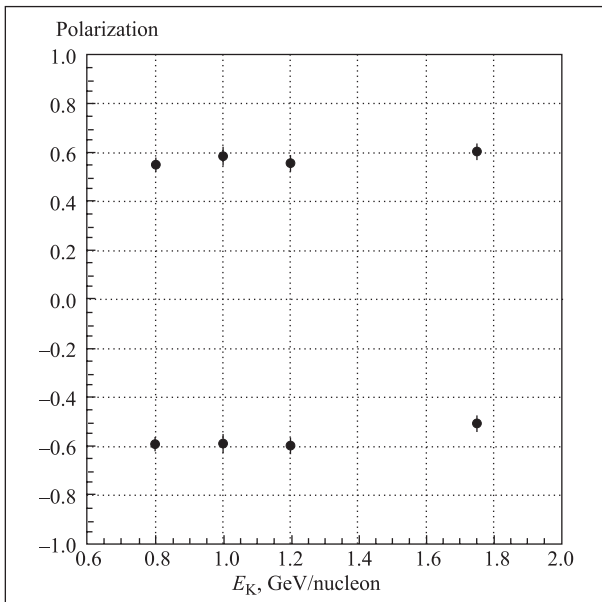

Fig. 6. Results of measurements of deuteron polarization at the circulating beam of the Nuclotron

this assembled system was used to measure the deuteron beam polarization inside the Nuclotron chamber at sev-

eral values of the energy. The results of the measurements are given in Fig. 6.

The assembled set-up has demonstrated an extremely high sensitivity. First measurements were carried out at the beam with an intensity of no more than 10^7 particles per cycle. Additionally, the regime of the joint operation with the beam extraction was realized. It allowed the experimentalists to carry out measurements simultaneously with the polarimeter installed in the focus F3. The values obtained turned out to be identical. The express output of the information from the set-up to the WWW-server was also realized.

In order to carry out the proposed experiments at the **GIBS set-up**, it was necessary to prepare the SPHERE spectrometer track detectors with proportional chambers. In 2002, the readout electronics of the proportional chambers was tuned for stable performance; two-meter EXCHARM proportional chambers were transported to VBLHE, and a list of technical problems was solved to commission the SPHERE track detector for experiments at the Nuclotron beams in 2003.

At the **STRELA set-up**, on the basis of the reaction $dp \rightarrow (pp)n$, the estimation of the spin-dependent part of the $np \rightarrow pn$ amplitude has been done under the conditions of full geometry [7].

EXPERIMENTS AT THE SYNCHROPHASOTRON

Experimental investigations of the analyzing power reduction at the polarized proton quasi-elastic scattering on nuclei were continued.

New experimental data have been obtained in the joint MSU-SPHERE experiment by the physicists of MSU's SINP and VBLHE. The analyzing power of the

quasi-elastic scattering by intranuclear protons and neutrons has been measured for carbon and copper nuclei in the inclusive $p \uparrow + {}^{12}\text{C}({}^{64}\text{Cu}) \rightarrow p_L + p(n)_R + X$ and exclusive $p \uparrow + {}^{12}\text{C}({}^{64}\text{Cu}) \rightarrow p_L + p_R + X$ reactions at 2.5 and 3.0 GeV. The aim of the experiment is to test critically the model predictions for the analyzing power reduction parameter. It is important that in the inclusive reaction an arbitrary value of the pp and pn analyzing power has been measured, but simultaneously at the detection of the recoil proton the pp scattering has been measured separately. So this experiment was sensitive to the possible difference of the pp and pn analyzing power reduction. The preliminary results are given in Fig. 7.

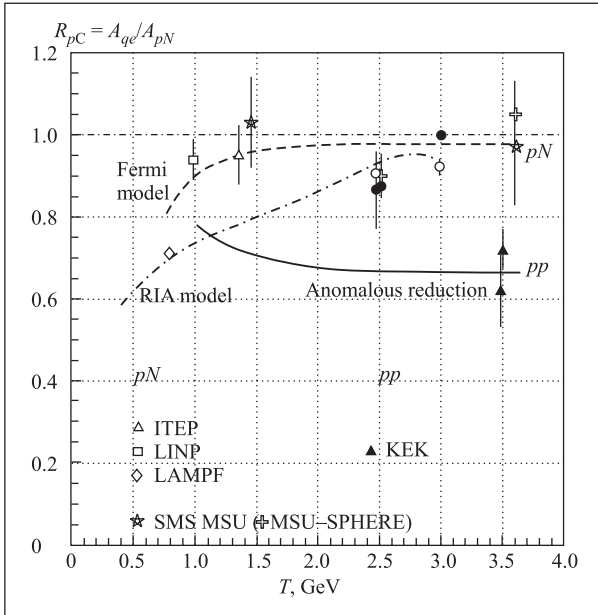

Fig. 7. New preliminary experimental data: the open points — measurement in the inclusive channel of reaction, full points — measurement with allocation of a proton of feedback

The experiment has been carried out at the polarized beam of JINR VBLHE Synchrotron, and the record beam parameters were achieved in the November 2002 run.

The preliminary results of the experiment are as follows:

- at GeV energies the reduction of the analyzing power is close for protons and neutrons;
- its behaviour is approximately described in the framework of the relativistic impulse approximation;
- there is no difference for the measurements on the copper and carbon target nuclei;
- the anomalous analyzing power reduction is not observed.

In the framework of the PIKASO experiment the same run fulfilled the measurement of the tensor analyzing power A_{yy} at the fragmentation of the polarized deuterons with an impulse of 5 GeV/c in cumulative pions $d + \text{Be} \rightarrow \pi + X$ at pion emission angles of 0

and 180 mrad. The goal of these measurements is to figure out the energy dependence of A_{yy} via comparison of the new data at 5 GeV/c and the previous data obtained at 9 GeV/c. This is very important to interpret the mechanism of the reaction and correlation of A_{yy} with the D -wave in the region of the proton core. The results of measurements are shown in Fig. 8 (full signs illustrate the new results at 5 GeV/c).

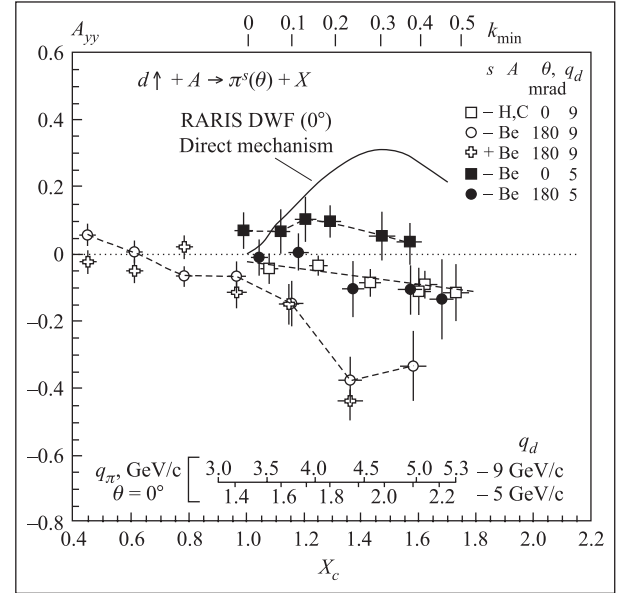

Fig. 8. Results of measurements of the tensor analyzing power A_{yy} at the fragmentation of polarized deuterons in cumulative pions $d + \text{Be} \rightarrow \pi + X$ at pion emission angles of 0 and 180 mrad (full signs demonstrate the new results at 5 GeV/c)

The main conclusions are:

- The energy dependence of A_{yy} in the interval of the deuteron momenta 5–9 GeV/c is very significant: at the zero angle of the pion emission, A_{yy} changes its sign.
- In the interval of the cumulative variable x_c from 1.0 to 1.5 the behaviour of A_{yy} at an angle of 180 mrad differs sufficiently at 5–9 GeV/c: significant growth of the absolute value of A_{yy} is observed at 9 GeV/c, which correlates with large values of the transverse pion momentum P_t at 9 GeV/c.
- Since P_t is a leading variable controlling the behaviour of A_{yy} , it is extremely important to study the behaviour of A_{yy} at big values of P_t (> 0.8 GeV/c).

These investigations can be continued at the Nuclotron when impulse range is higher than 6 GeV/c, that is why the achievement of the impulse from 6 to 12 GeV/c at the Nuclotron is extremely important for the future research programme of the spin structure of the nuclei at small distances (the data on A_{yy} and A_y at high impulse pion production is related to the structure of the meson currents in nuclei at small internucleon distances).

THEORETICAL RESEARCH AND INTERPRETATION OF THE EXPERIMENTAL DATA

Investigation of the interference of the identical pions has shown that the correlations depend on dynamics of the production volume and can be used to measure parameters of the production volume. For example, it has been shown that the pion production volume expands, the velocity and direction of the expansion were determined [8–11].

Ten resonances were found in the mass spectrum of the $\pi^+\pi^-$ system based on 66075 events from the reaction $np \rightarrow np\pi^+\pi^-$ in np interactions at $P_n = (5.20 \pm 0.16)$ GeV/c in the 1-m HBC of VBLHE by using the criterion $\cos \theta_p^* > 0$ (see Fig. 9). These masses are the following: (347 ± 12) , (418 ± 6) , (511 ± 12) , (610 ± 5) , (678 ± 17) , (757 ± 5) , (880 ± 12) , (987 ± 12) , (1133 ± 15) , and (1285 ± 22) MeV/c²;

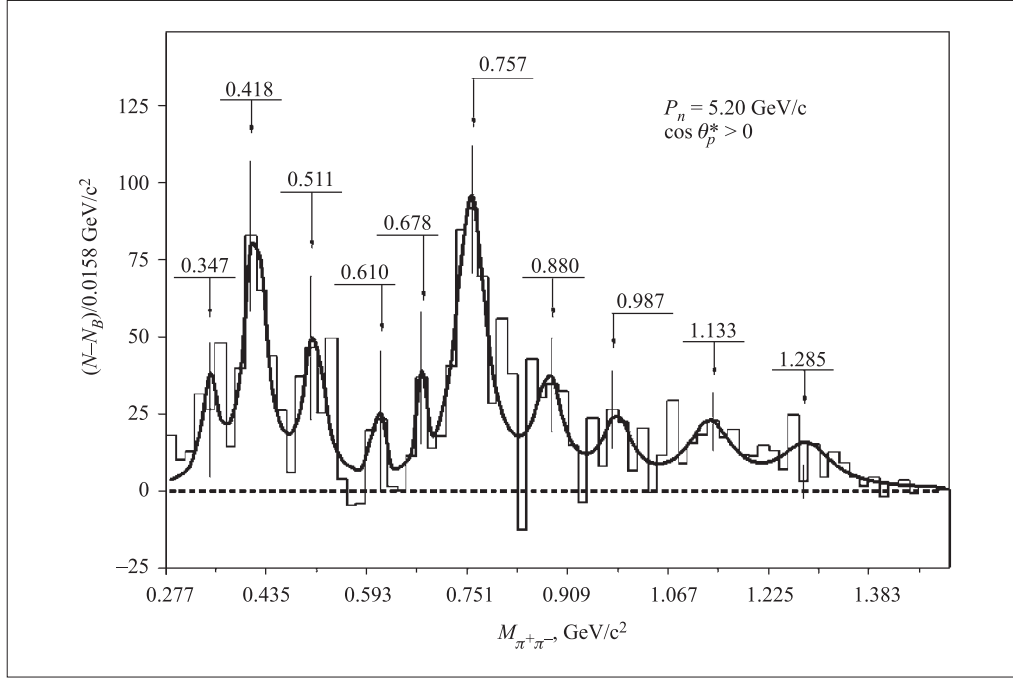

Fig. 9. The effective mass distribution of $\pi^+\pi^-$ combinations of the reaction $np \rightarrow np\pi^+\pi^-$

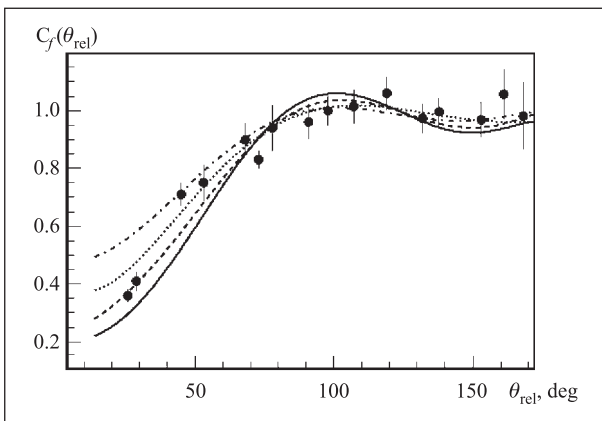

Fig. 10. Comparison of the measured correlation function (full circles) with the calculated ones for different mean decay times of the fragmenting system: solid, dashed, dotted and dash-dotted lines are for $\tau = 0, 50, 100$ and 200 fm/c. It has been found from the best fit that $\tau = (50 \pm 18)$ fm/c (90% C.L.)

$\pm 12)$, (1133 ± 15) , and (1285 ± 22) MeV/c²; their excess above the background is 2.9, 5.2, 3.5, 1.4, 2.0, 8.5, 4.8, 3.8, 5.2, and 6.0 S. D., respectively. The observed resonance at the mass $M_R = 757$ MeV/c² has been already inserted in RPP-2000, RPP-2002. The experimental widths of the resonances vary within the region from 16 to 94 MeV/c². Such effects were not found in $\pi^-\pi^0$ combinations from the reaction $np \rightarrow pp\pi^-\pi^0$. Therefore, it is necessary to attribute the value of isotopic spin $I = 0$ to the resonances found in the mass spectrum of the $\pi^+\pi^-$ system. The spin was estimated for the most statistically provided resonances at masses of 418, 511 and 757 MeV/c². It has been determined with a high degree of confidence that $J = 0$ for the resonances at $M_R = 757$ MeV/c² and $M_R = 418$ MeV/c² and the most probable value of $J = 0$ for the resonance at $M_R = 511$ MeV/c². Therefore, it can be affirmed that at least three states with quantum numbers of σ_0 meson $0^+(0^{++})$ have been found at masses of 418, 511 and 757 MeV/c². The fact that low-mass σ_0 mesons are glueballs is one of the possible interpretations. The

comparison with the data of other papers has also been made [12].

The scientific goal of the FASA project (spokesmen V. A. Karnaukhov and H. Oeschler (TU, Darmstadt)) is a study of the thermal nuclear multifragmentation induced by the light relativistic ions in heavy targets. This is a new multibody decay process of the hot target spectator with the copious emission of the intermediate-mass fragments (IMF, $2 < Z < 20$). In previous studies of the FASA collaboration, it has been shown that this type of disintegration takes place after an expansion of the excited nucleus driven by the thermal pressure. The break-up density is $\rho_b \approx 0.3\rho_0$ (normal nuclear density) and the temperature is 5–7 MeV [13]. These findings correspond to the onset of the multifragmentation of nucleus entering the phase coexistence (spinodal) region. Due to the density fluctuations, a homogeneous system converts into a mixed phase, consisting of charged droplets (IMFs) surrounded by the nuclear gas. This is a «nuclear fog», which expands because of Coulomb repulsion. The time scale of this transformation should be very short.

The crucial point to confirm this scenario is measuring the decay time of the fragmenting system for $p(8.1 \text{ GeV}) + \text{Au}$ collisions. That case is the most adequate for thermodynamic treatment of the process. It was done by the analysis of the relative angle correlation of the intermediate-mass fragments [14]. The strong suppression of the yield of the fragment pairs at the small angles was observed caused by the IMF–IMF Coulomb repulsion (Fig. 10). The experimental correlation function (which is proportional to the IMFs yield) was compared to that obtained by the multibody Coulomb trajectory calculations with various decay times τ of the fragmenting system. The combined model, including the modified intranuclear cascade followed by the statistical multifragmentation model, was used to generate the starting conditions for these calculations. It was found that $\tau = (50 \pm 18) \text{ fm}/c$. Em-

phasis was put on the model dependence of the results obtained: a) two variants of the combined model have been used for which the properties of the fragmenting nuclei are different; b) dependence of the results on the instant of the secondary decay of the hot primary fragment was controlled; c) the sensitivity of the shape of correlation function on the size of the break-up volume was checked. It has been found that the measured mean lifetime of the system is always $\tau \leq 70 \text{ fm}/c$ (Fig. 11).

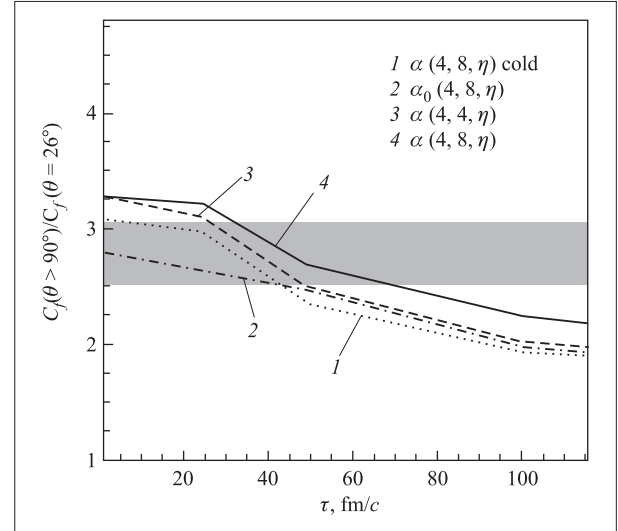

Fig. 11. Ratio of the correlation function at $\theta_{\text{rel}} > 90^\circ$ to that at $\theta_{\text{rel}} = 26^\circ$ versus the mean decay time of the system. The experimental value is given by the horizontal band, the lines are calculated using different model parameters. The mean lifetime of the system is always $\leq 70 \text{ fm}/c$

The measured time scale is close to that for the density fluctuation in the diluted nuclear system. So, the thermal multifragmentation can be interpreted as the first-order nuclear «liquid–fog» phase transition in the spinodal region [15].

COOPERATION WITH OTHER SCIENTIFIC CENTRES

VBLHE participates in the Heavy Ion programme at CERN's SPS. The physicists are involved in NA45 (CERES) (contactperson from JINR Dr Yu. A. Panebrattsev), NA49 (contactperson from JINR Dr G. L. Melkumov).

Data taking and analysis of the data obtained earlier by the NA49 collaboration are continued. New results have been presented on the study of production of Λ hyperons, charged pions and kaons in central interactions Pb + Pb at 40, 80 and 158 $A \cdot \text{GeV}$ [16–18].

In 2002 the CERES collaboration carried out a large amount of work concerning data 2000 calibration and mass-production preparation. In particular, the rated value of the momentum resolution of the unique radial electron drift Time-Projection Chamber (TPC) has been achieved.

The physics results of the collaboration in 2002 were presented by three talks at the QM'02 conference and papers [19–22]. The main CERES/NA45 talk (J. Wessels for the CERES collaboration, in press)

reported the latest results on e^+e^- -pair production in Pb–Au nuclear collisions at 40 and 158 $A \cdot \text{GeV}$. The observed e^+e^- -pair production enhancement in comparison with theoretical estimations in the low-effective mass region (0.2–0.6 GeV/c^2) has a greater value for the 40 $A \cdot \text{GeV}$ data set and cannot be described in the framework of $\pi^+\pi^-$ -annihilation models.

The talk concerning the current analysis of the 1996 CERES data (J. Slivova for the CERES collaboration, in press) presented elliptic flow estimations with the two-particle correlations taken into account. The latter give systematically higher v_2 values at $p_T > 1.2 \text{ GeV}/c$, providing possibly the evidence of a nonflow semihard component.

First results of the 2000 data analysis taken with the TPC were reported at the conference (H. Tilsner, H. Appelshauser for the CERES collaboration, in press). The talk presented the results on HBT studies of the like-sign pions in the midrapidity region for 40, 80 and 158 $A \cdot \text{GeV}$ data sets. These studies have shown that the data are consistent with a scenario where thermal pion freeze-out occurs at a constant mean free path of pions in the surrounding matter, independent of beam energy from AGS to RHIC.

The VBLHE physicists participated in the development of the Heavy Ion programme for the CMS experiment and, jointly with the Laboratory of Particle Physics of JINR, in preparation of the muon chambers tested by the CMS cosmic ray system.

Two VBLHE groups are involved in the STAR (contactperson from JINR Professor Yu. A. Panebrattsev) and PHENIX (contactperson from JINR Dr A. G. Litvinenko) experiments at RHIC of BNL. These groups have participated in the run preparation and data taking at a new nuclear collider RHIC at 130 $A \cdot \text{GeV}$ energy.

In the framework of the STAR experiment, inclusive transverse momentum distributions of charged hadrons within $0.2 < p_T < 6.0 \text{ GeV}/c$ have been measured over a broad range of centrality for Au + Au collisions at $\sqrt{s_{NN}} = 130 \text{ GeV}$. Hadron yields are suppressed at high p_T in central collisions relative to peripheral collisions and to a nucleon–nucleon reference scaled for collision geometry. Peripheral collisions are not suppressed relative to the nucleon–nucleon reference. The suppression varies continuously at intermediate centralities. The results indicate significant nuclear medium effects on high p_T hadron production in heavy ion collisions at high energy [23].

Azimuthal correlations for large transverse momentum charged hadrons have been measured over a wide pseudorapidity range and full azimuth in Au + Au and $p + p$ collisions at $\sqrt{s_{NN}} = 200 \text{ GeV}$. The small-angle correlations observed in $p + p$ collisions and at all centralities of Au + Au collisions are characteristic of hard-scattering processes already observed in elementary collisions. A strong back-to-back correlation exists for $p + p$ and peripheral Au + Au collisions. In contrast,

the back-to-back correlations are reduced considerably in the most central Au + Au collisions, indicating substantial interaction as the hard-scattered partons or their fragmentation products traverse the medium [24].

Within the ALICE experiment, the manufacturing process of the ALICE dipole magnet iron yoke was finished in December, 2002, at the SMZ factory (Kimry). The certified clean room facility for the construction of the particle detectors was developed. A new tracking method was developed for the ALICE muon spectrometer. A scientific programme was proposed to study anomalous effects in the Vavilov–Cherenkov radiation of the gold ions extracted from the RHIC collider.

The high-precision drift chambers, read-out electronics for the inner part of the spectrum and for the track-search programme have been developed and integrated to the HADES set-up at VBLHE. The chambers and mathematical software are successfully used in the first physics experiments at the SIS accelerator (GSI, Darmstadt).

The WASA/PROMICE facility in the beams of the CELSIUS accelerator (Uppsala, Sweden) has obtained experimental data on the mechanisms of the proton–proton and proton–deuteron interactions in the over-threshold energy region. The differential cross sections of the reaction $pd \rightarrow {}^3\text{He} + \eta$ have been measured in the energy interval of the protons from 930 to 1100 MeV. For the first time in the exclusive performance the reaction $dp \rightarrow dp\gamma$ has been studied experimentally in the energy interval from 436.7 to 559.0 MeV. The reaction $pp \rightarrow pp\pi^+\pi^-$ has been also studied for the first time with the bigger statistics near the energy threshold [25–27].

REFERENCES

1. *Kovalenko A. D.* // Proc. of the Intern. Symp. «The 50th anniversary of the discovery of phase stability principle», July 12–15, 1994 / Ed. A. M. Baldin et al. Dubna, 1996. P. 44–55.
2. *Malakhov A. I.* // Phys. At. Nucl. 2002. V. 65, No. 2. P. 211–219.
3. *Carrigan R. A., Jr., et al.* Beam extraction studies at 900 GeV using a channeling crystal // Phys. Rev. Special Topics — Accelerators and Beams. 2002. V. 5. P. 043501.
4. *Biino C. et al.* On the reduced interaction probability for fully stripped 33 TeV/c Pb ions channeled in a bent Si crystal // Nucl. Instr. Meth. B. 2002. V. 194. P. 417.
5. *Agapov N. N. et al.* Advances in Cryogenic Engineering AIP. Meville: N. Y., 2002. V. 47A. P. 280.

6. CERN Courier. 2002. V. 42, No. 8. P. 24.
7. *Glagolev V. V. et al.* // Eur. Phys. J. A. 2002. V. 15. P. 471; epja1401.
8. *Golokhvastov A. I.* Interference correlations of pions and elementary phase space cell // *Yad. Fiz.* 2002. V. 65. P. 196.
9. *Anikina M. Kh., Golokhvastov A. I., Lukstins Yu.* Dependence of the interferometric sizes of pion generation volume on sizes of their wave packet // *Ibid.* P. 600.
10. *Аникина М. Х. и др.* Direction of the pion generation volume expansion in MgMg collisions at 4.3 A · GeV/c. JINR Preprint P2-2002-177. Dubna, 2002; *Yad. Fiz.* 2003. V. 66, No. 10 (in press).
11. *Голохвастов А. И.* Scaling of semi-inclusive events in *pp* interactions. JINR Preprint P2-2002-92. Dubna, 2002; *Yad. Fiz.* 2003. V. 66, No. 9 (in press).
12. *Troyan Yu. A. et al.* // *Part. Nucl., Lett.* 2002. No. 5 [114]; JINR Preprint E1-2002-214. Dubna, 2002.
13. *Avdeyev S. P. et al.* // *Nucl. Phys. A.* 2002. V. 709. P. 392.
14. *Rodionov V. K. et al.* // *Nucl. Phys. A.* 2002. V. 700. P. 457.
15. *Karnaukhov V. A. et al.* Thermal multifragmentation of hot nuclei and liquid-fog phase transition. JINR Preprint E6-2002-75. Dubna, 2002; *Phys. At. Nucl.* (in press).
16. *Afanasiev S. V. et al.* // *Phys. Lett. B.* 2002. V. 538. P. 275–281.
17. *Afanasiev S. V. et al.* // *J. Phys. G.* 2002. V. 28. P. 1761–1768.
18. *Afanasiev S. V. et al.* // *Nucl. Phys. A.* 2002. V. 698. P. 104–111.
19. *Schmitz W. et al. (CERES collab.).* Λ production in 40 A · GeV/c PbAu collisions // *J. Phys. G.* 2002. V. 28. P. 1861–1868; nucl-ex/0201002.
20. *Adamova D. et al. (CERES collab.).* New results from CERES // *Nucl. Phys. A.* 2002. V. 698. P. 253–260.
21. *Adamova D. et al. (CERES collab.).* Beam energy and centrality dependence of two pion Bose–Einstein correlations at SPS energies // *Nucl. Phys. A.* 2003. V. 714. P. 124–144; nucl-ex/0207005.
22. *Adamova D. et al. (CERES collab.).* Universal pion freezeout in heavy ion collisions // *Phys. Rev. Lett.* (submitted); nucl-ex/0207008.
23. *Adler C. et al. (STAR collab.).* Centrality dependence of high p_T hadron suppression in Au+Au collisions at $\sqrt{s_{NN}} = 130$ GeV // *Phys. Rev. Lett.* 2002. V. 89. P. 202301; nucl-ex/0206011.
24. *Adler C. et al. (STAR collab.).* Disappearance of back-to-back high p_T hadron correlations in central Au+Au collisions at $\sqrt{s_{NN}} = 200$ GeV // *Phys. Rev. Lett.* (submitted); nucl-ex/0210033.
25. *Bilger R. et al.* // *Phys. Rev. C.* 2002. V. 65. P. 044608.
26. *Greff J. et al.* // *Ibid.* P. 034009.
27. *Brodski W. et al.* // *Phys. Rev. Lett.* 2002. V. 88, No. 19. P. 192301.

LABORATORY OF PARTICLE PHYSICS

The activity of LPP in 2002 was concentrated on the current particle physics experiments and prepara-

tion of the new ones, R&D of the particle detectors and different acceleration systems.

CURRENT EXPERIMENTS

The **EXCHARM** experiment [1] is devoted to the study of the charmed and strange particle production in neutron–nucleon interactions at the Serpukhov U-70 accelerator. The final results on the cross sections of antihyperons inclusive production in neutron–carbon interactions have been published in [2]:

$$\sigma(\bar{\Lambda}^0) = (154.0 \pm 1.2(\text{stat.}) \pm 17.6(\text{syst.}) \pm 18.0(\text{sim.}) \mu\text{b/nucleon},$$

$$\sigma(\bar{\Xi}^+) = (7.9 \pm 0.4(\text{stat.}) \pm 0.7(\text{syst.}) \pm 0.9(\text{sim.}) \mu\text{b/nucleon},$$

$$\sigma(\bar{\Sigma}^-(1385)) = (10.2 \pm 1.6(\text{stat.}) \pm 0.8(\text{syst.}) \pm 0.6(\text{sim.}) \mu\text{b/nucleon},$$

$$\sigma(\bar{\Sigma}^+(1385)) = (8.2 \pm 2.8(\text{stat.}) \pm 0.7(\text{syst.}) \pm 0.9(\text{sim.}) \mu\text{b/nucleon}.$$

New data were obtained on pair Λ^0 -hyperon interference correlations [3], and destructive correlations were observed in the region of small relative four-momentum. A value of R was obtained as a result of approximation of Λ^0 pair spectra by a function $C_2(Q) = [1 + \lambda \exp(-R^2Q^2)](a + bQ)$. Comparison with the meson correlations data testifies the reduction of the size of particle-generation area with increasing of the particle mass. Preliminary results on pair pion and kaon interference correlations were obtained [4]. The observed constructive correlations of negatively charged

pion pair and neutral kaon pair in the region of small relative four-momentum have allowed one to estimate the geometrical size of sources. A value of R was obtained as a result of approximation of identical meson pair spectra by a function $C_2(Q)$. Preliminary results on the inclusive production cross sections of Ω^- and $\bar{\Omega}^+$ and production asymmetry are as follows:

$$\sigma(\Omega^-) = (1.34 \pm 0.20) \mu\text{b/nucleon}, \quad (1)$$

$$\sigma(\bar{\Omega}^+) = (0.40 \pm 0.11) \mu\text{b/nucleon}, \quad (2)$$

$$\frac{\sigma(\Omega^-) - \sigma(\bar{\Omega}^+)}{\sigma(\Omega^-) + \sigma(\bar{\Omega}^+)} = 0.54 \pm 0.20. \quad (3)$$

A group of LPP physicists actively participates in the **NA48** experiment at CERN, devoted to the precision measurement of the ratio ε'/ε in CP -violating decays $K_L^0 \rightarrow \pi\pi$ [5]. The main programme of the experiment has been completed with significant material and intellectual contribution of the LPP employees. The measured value of the direct CP violation, $\text{Re}(\varepsilon'/\varepsilon) = (14.7 \pm 2.2) \cdot 10^{-4}$, differs from zero by beyond 6.7 standard deviations [6] (see Fig. 1).

A precision measurement of the K_S^0 lifetime has been performed: $\tau(K_S^0) = (0.89598 \pm 0.00048(\text{stat.}) \pm 0.00051(\text{syst.}) \cdot 10^{-10} \text{ s}$ [7]. The K_S^0 lifetime is derived from the ratio of decay time distributions in simultaneous and collinear K_S^0 and K_L^0 beams, giving a result which is approximately independent of the detector acceptance and has reduced systematic errors. New measurements of the η and K^0 masses have been

performed via their decays to three neutral pions [8]. The results of $m(\eta) = 547.843 \pm 0.051 \text{ MeV}/c^2$ and $m(K^0) = 497.625 \pm 0.031 \text{ MeV}/c^2$ were obtained

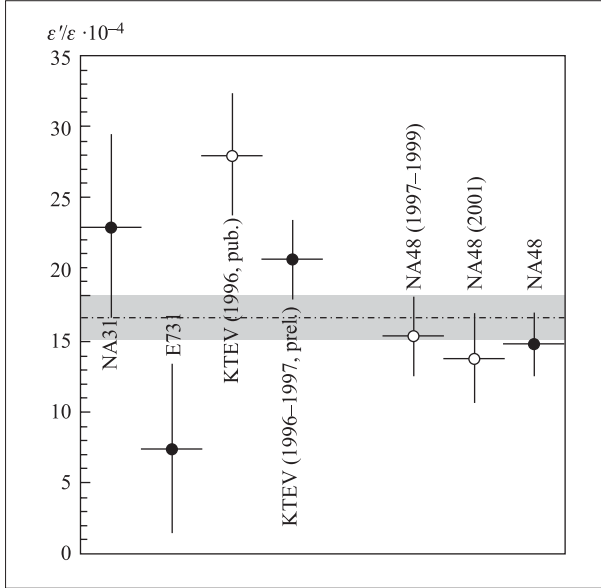

Fig. 1. Comparison of the NA48 results on the ratio $\text{Re}(\epsilon'/\epsilon)$ with other measurements

with reduced systematic errors due to symmetric decays. The decay rate of $K_L^0 \rightarrow \pi^0 \gamma \gamma$ has been measured [9]. In total, 2558 $K_L^0 \rightarrow \pi^0 \gamma \gamma$ candidates have been selected with a residual background of 3.2%. The branching ratio has been determined to be equal to $(1.36 \pm 0.03(\text{stat.}) \pm 0.03(\text{syst.}) \pm 0.03(\text{norm.})) \cdot 10^{-6}$ and the vector coupling constant is $a_V = -0.46 \pm 0.03(\text{stat.}) \pm 0.04(\text{syst.})$. This result indicates that CP -violation effects are dominating in the $K_L^0 \rightarrow \pi^0 \gamma \gamma$ decay. The upper limit for the $K_L^0 \rightarrow \pi^0 \gamma \gamma$ decay rate in the two-photon mass region $m(\gamma\gamma) < m(\pi^0)$ has been obtained as well.

The Dubna group took an active part in data taking, data analysis and technical maintenance of the system of mini-Drift Vertex Chambers (DVC) of HERMES Spectrometer Front Tracking at HERA, DESY, Hamburg. The DVCs provide the stable HERMES forward tracking with efficiency at a level of 98% and high spatial resolution ($\sim 150 \mu\text{m}$). All chambers were transported to DESY, tested and are ready to be installed. The Dubna group has also finished the production of front-end card (Amplifier/Shaper/Discriminator): 88 cards were tested and prepared to be used for data taking.

The Dubna physicists participate in the analysis of the HERMES polarized data to study the Q^2 -dependence of the generalized Gerasimov–Drell–Hearn (GDH) integral for the deuteron and neutron. The analysis of the 2000 HERMES experimental data taken with deuteron tensor polarization was performed to measure the deuteron tensor asymmetry A_T and structure function b_1 . The tensor asymmetry was measured

for the first time over the kinematic range $0.0021 \leq x \leq 0.85$, where x is Bjorken scaling variable, and $0.1 \leq Q^2 \leq 20 \text{ GeV}^2$ [10]. The asymmetry A_T gives

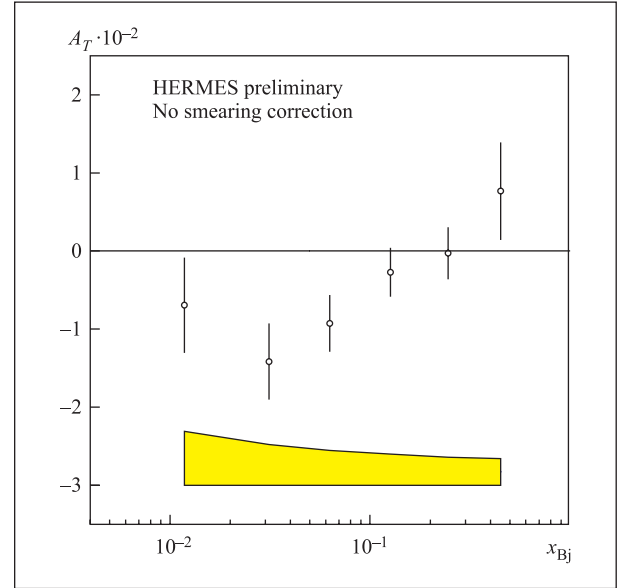

Fig. 2. The tensor asymmetry as a function of Bjorken scaling variable x . The error bars and bands represent the statistical and systematic uncertainties, respectively

access to the deuteron structure function b_1 which correlates the partonic momentum distribution with the spin of the nucleon. The asymmetry A_T was found to be compatible with zero within the total statistical and systematic uncertainties (see Fig. 2). This result favours the picture of a deuteron as a loosely bound state of p and n . Furthermore, the possible effect from tensor polarization of the $A_{||}$ measurements was constrained from data analysis to be less than $(0.5 \div 1.0) \cdot 10^{-2}$.

The single-spin azimuthal asymmetry in exclusive electroproduction of π^+ mesons has been measured for the first time in deep-inelastic scattering (DIS) of positrons and the longitudinally polarized protons [11]. Integrated over the experimental acceptance, the $\sin \phi$ moment of the polarization asymmetry of the cross section is measured to be $-0.18 \pm 0.05(\text{stat.}) \pm 0.02(\text{syst.})$ (see Fig. 3). The asymmetry is also studied as a function of the relevant kinematic variables (see Fig. 4), and its magnitude is found to grow with decreasing of Bjorken scaling variable x and increasing of $-t$ and to vanish at $t \rightarrow t_{\min}$, where t is the squared four-momentum transferred to nucleon.

Spin-dependent lepton scattering HERMES data have been used to investigate the validity of the concept of quark–hadron duality for asymmetries measured in polarized experiments. Longitudinally polarized positrons were scattered off a longitudinally polarized hydrogen target for values of the squared invariant mass between $1 \leq W^2 \leq 4 \text{ GeV}^2$ [12]. The double-spin asymmetry of the cross section in the nucleon resonance domain is found to agree with the asymmetry

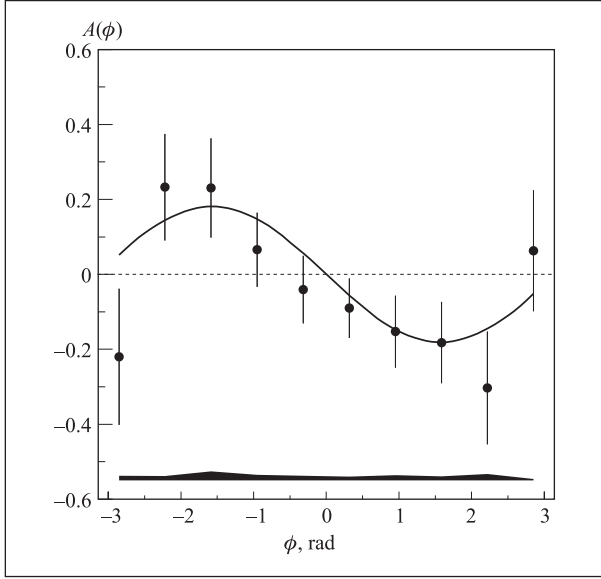

Fig. 3. Cross-section asymmetry $A(\phi)$ averaged over x , Q^2 , and t for the reaction $e^+ + \vec{p} \rightarrow e'^+ + n + \pi^+$. The curve is the best fit to the data by $A(\phi) = A_{\text{UL}}^{\sin \phi} \sin \phi$ with $A_{\text{UL}}^{\sin \phi} = -0.18 \pm 0.05$ at a reduced χ^2 of 0.8. The error bars and bands represent the statistical and systematic uncertainties, respectively

measured in DIS at the same values of the Bjorken scaling variable x for the entire Q^2 range covered by the HERMES experiment. This finding implies that the description of asymmetries in terms of quark degrees of freedom is also valid in the nucleon resonance region.

LPP participates in upgrade of the **H1** detector [13] to investigate DIS processes at the ep collider HERA, DESY, in particular, in the software/hardware support of the Forward Proton Spectrometer (FPS) operation and in the upgrading of the Hadron Plug Calorimeter and Backward Proportional Chambers. The LPP group has made a major contribution to the analysis of data on the processes with a leading proton detected in the FPS: photoproduction, semi-inclusive diffractive DIS, and the elastic ρ -meson photoproduction.

The differential cross section $d\sigma/dt$ and the structure function $F_2^{D(3)}(x_{\text{IP}}, x, Q^2)$ have been measured in diffractive DIS processes with a leading proton in the final state. A fit of the differential cross section $d\sigma/dt \propto \exp(Bt)$ yields a slope parameter $B = 5.0 \pm 0.3(\text{stat.}) \pm 0.8(\text{syst.}) \text{ GeV}^{-2}$ in the range $2 < Q^2 < 50 \text{ GeV}^2$ and $x_{\text{IP}} = 1 - z < 0.1$, where x_{IP} is a fractional momentum of the beam proton carried by Pomeron. No dependence of t slope on x_{IP} was observed within the measurement errors. Comparison of the $F_2^{D(3)}$ data with previous result obtained by H1 FPS in the nondiffractive high x_{IP} range has shown the behaviour consistent with the transition from Pomeron exchange at $x_{\text{IP}} < 0.05$ to the dominance of Reggeon and π exchange at $x_{\text{IP}} > 0.05$.

The elastic photoproduction of ρ mesons has been studied by measuring the final state of the leading proton. The measurement extends the centre-of-mass energy range to $25 < W < 70 \text{ GeV}$, thereby further reducing the kinematic separation between the HERA and fixed target measurements. The results

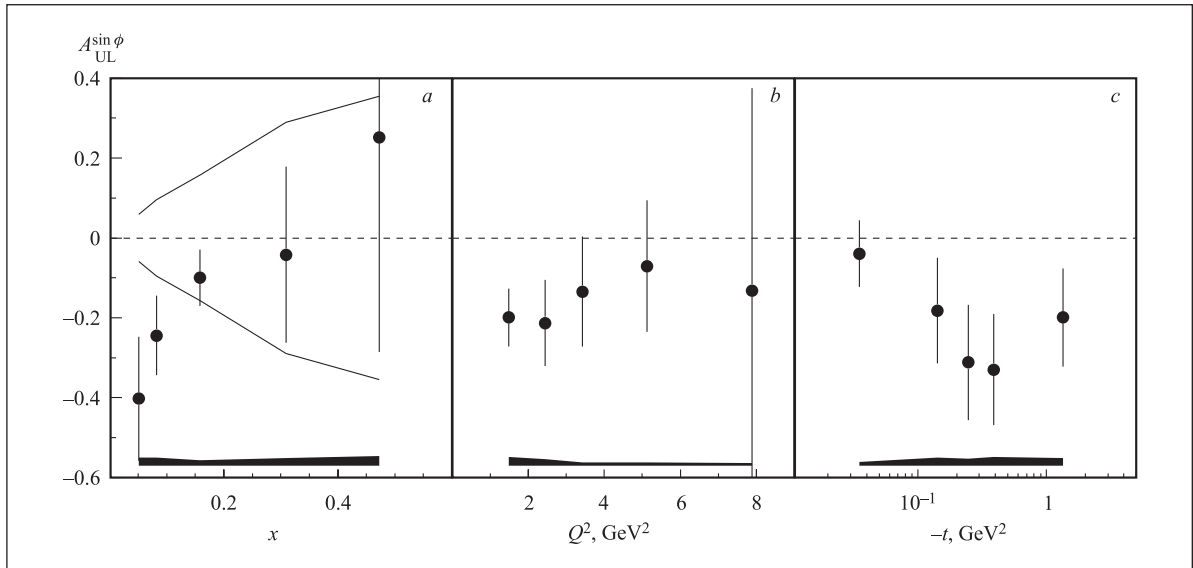

Fig. 4. Kinematic dependence of $A_{\text{UL}}^{\sin \phi}$ on the variables x (a), Q^2 (b), and t (c) for the reaction $e^+ + \vec{p} \rightarrow e'^+ + n + \pi^+$. The error bars and bands represent the statistical and systematic uncertainties, respectively. The solid lines show the upper limits for any asymmetry arising from the transverse target polarization component

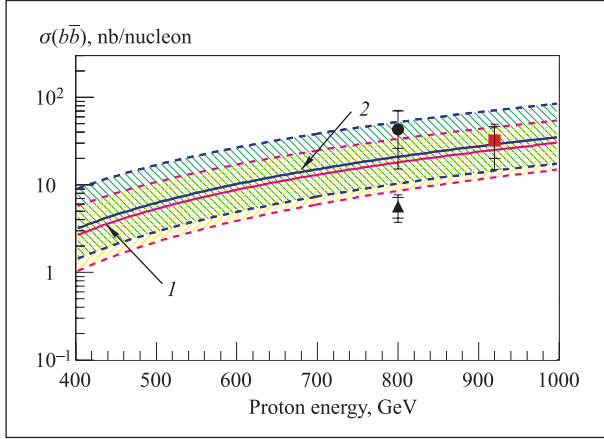

Fig. 5. Dependence of $\sigma(b\bar{b})$ on the proton energy. The HERA-B measurement (■) is compared with the previous measurements by E789 (▲) and E771 (●), as well as the theoretical predictions of Bonciani et al. (2002) (curve 1) and Kidonakis et al. (2001) (curve 2)

are in agreement with assumptions of the Vector Meson Dominance Model and Regge theory. The measured slope of the Pomeron trajectory is compatible with a value of $\alpha'_{\text{IP}} = 0.25 \text{ GeV}^2$ extracted from hadron-hadron elastic scattering cross sections. The t slope of the $d\sigma/dt \propto \exp(Bt)$ cross section $B = 10.3 \pm 0.8(\text{stat.}) \pm 0.5(\text{syst.}) \text{ GeV}^{-2}$ is in a good agreement with earlier photoproduction results from the H1 and ZEUS experiments. The decay angular distribution analysis has shown a compatibility with the assumption that s -channel helicity is conserved in this process.

According to the JINR commitments, LPP participates in the commissioning of the Outer Tracker of the **HERA-B** detector [14], which is a large-aperture spectrometer built for studies of collisions of 920-GeV protons with the nuclei of target wires positioned in the halo of the HERA proton beam. JINR physicists participate in the software development, HERA-B running and data analysis [15]. Dubna group is involved in further development of physics programme at the HERA-B facilities, in particular, in Monte-Carlo investigations of $B-\bar{B}$ production asymmetry and semileptonic B decays as well as in the study of the HERA-B potential for charmonium and bottomonium production physics [16].

Using the data acquired in a short physics run during the HERA-B commissioning period in summer, 2000, the $b\bar{b}$ -production cross section has been measured in 920-GeV proton collisions on the carbon and titanium targets [17]. The $b\bar{b}$ production was tagged via inclusive bottom quark decays into J/ψ by exploiting the longitudinal separation of $J/\psi \rightarrow l^+l^-$ decays from the primary proton-nucleus interaction. For the first time, $\sigma(b\bar{b})$ has been measured by using both $\mu^+\mu^-$ and e^+e^- dilepton channels of J/ψ decay in the fixed-target experiments. The measurements cover the J/ψ Feynman- x (x_F) range $-0.25 \leq x_F \leq 0.15$. The com-

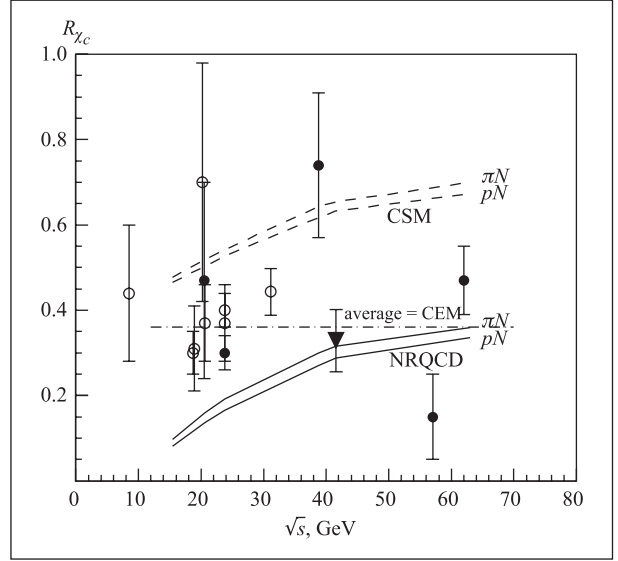

Fig. 6. Comparison of the HERA-B measurement of R_{χ_c} (closed triangles) with those of other pp , pA (closed circles) and πp , πA (open circles) experiments. Also shown are predictions for pN and πN interactions based on the NRQCD (solid curves), CSM (dashed curves), and CEM (dash-dotted line) theoretical models. The CEM value here is an average of the pp , pA , πp and πA data

bined analysis of $\mu^+\mu^-$ and e^+e^- data, with extrapolating to the full x_F range, yields the total cross section:

$$\sigma(b\bar{b}) = 32_{-12}^{+14}(\text{stat.})_{-7}^{+6}(\text{syst.}) \text{ nb/nucleon.}$$

This result is in a good agreement with the most recent QCD calculations beyond next-to-leading order (see Fig. 5). In the same figure, the E789 and E771 experimental results obtained with 800-GeV proton interactions on Au and Si, respectively, are plotted and seen to be compatible.

The fraction R_{χ_c} of J/ψ particles originating from the radiative decays $\chi_c \rightarrow J/\psi \gamma$ of different χ_c states, produced via $p\text{-C}$ and $p\text{-Ti}$ interactions, has been measured [18]. The specific decay, $\chi_c \rightarrow J/\psi \gamma$, is advantageous since it allows for triggering on the decay signature $J/\psi \rightarrow l^+l^-$. In this case, several systematic errors cancel in the ratio R_{χ_c} , and the only significant difference in the detection of the two states is caused by the photon. The χ_c 's are reconstructed in the decay $\chi_c \rightarrow J/\psi \gamma \rightarrow l^+l^-\gamma$ as the signal in the distribution ΔM , which is the difference between the invariant mass of the $(l^+l^-\gamma)$ system and the invariant mass of the (l^+l^-) system: $\Delta M \equiv M(l^+l^-\gamma) - M(l^+l^-)$. The average result from different samples is

$$\langle R_{\chi_c} \rangle = 0.321 \pm 0.064(\text{stat.}) \pm 0.037(\text{syst.}).$$

As is shown in Fig. 6, the HERA-B result is compatible with previous measurements of proton- and pion-induced reactions. It is interesting to note that most of the measurements fall below the prediction of Colour

Singlet Model (CSM). The HERA-B result confirms this behaviour, being almost two standard deviations below the CSM prediction. The proton and pion data can help to tune the free parameters for χ_c production in the Non-Relativistic QCD model (NRQCD), but better data are needed to choose between NRQCD and Colour Evaporation Model (CEM).

The LPP specialists participate in the construction of the low-noise neutrino detector **BOREXINO** [19], located at the underground laboratory in Gran Sasso (Italy). The prototype of the BOREXINO detector, Counting Test Facility (CTF), has been installed. It is aimed at studying a new type of the liquid scintillator, the efficiency of radio-purification as well as the methods of low-radioactivity control. The data of

background measurements at CTF have been used to obtain the upper bound on the magnetic moment of pp - and ${}^7\text{Be}$ -solar neutrino, $\mu_\nu \leq 5.5 \cdot 10^{-10} \mu_B$ [20]. This value is only three times lower than that obtained for reactor's neutrino and ${}^8\text{B}$ -solar neutrino. The new lower limit on the mean lifetime of neutrino relative to its radiative decay has been obtained: $\tau(\nu_H \rightarrow \nu_L + \gamma)/m_\nu \geq 1.5 \cdot 10^3 \text{ s/eV}$ [20]. It is more than one order of magnitude higher than that obtained in previous direct laboratory experiments with reactor's neutrino. The CTF data have also been used to obtain a bound on the electron stability relative to the decay $e^- \rightarrow \gamma + \nu_e$. The new lower limit on the mean lifetime based on 32 days of data taking is $\tau(e^- \rightarrow \gamma + \nu_e) \geq 4.6 \cdot 10^{26} \text{ y}$ (90 % C.L.) [21].

PREPARATION OF NEW EXPERIMENTS

A new experimental programme **NA48/1** on study of rare decays of K_S^0 has started. The experimental run 2002 has been carried out with active participation of a JINR group.

The preparation of a new experimental programme dedicated to the search for direct CP violation in charged kaon decays in 2003 by using the equipment of the NA48 experiment, the experiment **NA48/2**, has been started with active participation of LPP specialists. The contributions of JINR physicists cover simulation of the experimental conditions, software development for filtering and monitoring of physics characteristics of the obtained information, design and production of read-out electronics for the new coordinate detector of charged kaon beams — KABES.

The Common Muon and Proton Apparatus for Structure and Spectroscopy, **COMPASS (NA58)**, has been proposed to perform a series of experiments with the high-energy muon and hadron beams at CERN, including a study of inclusive and semi-inclusive DIS of muons on polarized targets, search for effects of the nucleon strange sea polarization in the production of Λ hyperons, and determination of the quark and gluon contribution to the nucleon spin.

JINR has participated in the construction, beam tests and commissioning of various COMPASS detectors. The HCAL1 detector, which is under full responsibility of JINR, has been recalibrated and now is ready for data taking. To speed up the production of straw-tube drift chambers for the COMPASS Tracking Station 2 (TS2), the second production line is being constructed at LPP. All 15 double layers of the TS2 were delivered to CERN. JINR experts together with Torino specialists have refurbished the multiwire pro-

portional chambers and drift chambers to be used in the Large Area Tracking detector placed along the COMPASS set-up. All chambers have been tested with new electronics and were operational during the COMPASS runs. Boxes and proportional tubes for Muon detector (MW1), which is also under full responsibility of JINR, have been produced in Dubna and tested at CERN. Amplifiers and discriminators for the MW1 read-out system have also been tested. In 2002, the MW1 was fully equipped with readout supplied by Torino and was operational for physics run.

LPP participates in the construction of the Liquid Argon Hadronic Endcap Calorimeter (LArHEC) and Transition Radiation Tracker (TRT), according to the JINR obligations in the **ATLAS** experiment, which is under preparation at CERN. In 2002, the construction of the systems and modules of the LArHEC was continued as well as the investigations of the properties of the construction materials and electrical components at the IBR-2 reactor [22], and analysis of the experimental data from the beam tests of the calorimeter modules at CERN [23]. The copper absorber production for LArHEC has been completed. The assembly of two LArHEC wheels was performed at CERN with participation of Dubna specialists. The temperature measuring system has been constructed and assembled at the LArHEC wheels. Spin effects in the processes of the single and pair production of t quarks in pp collisions at LHC are under studies.

The main activity of LPP within the Compact Muon Solenoid Project (**CMS**) was concentrated on the study, design, integration, and production of the CMS Endcap detectors, where JINR takes a full responsibility in the framework of the Russia and Dubna Member

States (RDMS) of the CMS collaboration. The JINR group participates in the following projects: Endcap Hadron Calorimetry (HE), First Forward Muon Station (ME1/1), Endcap Preshower (SE), and Physics Task Force.

Assembly and installation of the first Endcap Hadron Calorimeter was started at CERN in September, 2002, in accordance with the CMS construction schedule. Production of the HE+1 mechanics is going on. Simulation of radiation damage in HE scintillating tiles and pion energy resolution has been performed [24].

The mass-production of the cathode strip chambers (CSC) of the ME1/1 station is on schedule in Dubna. Thirty-three CSC were produced at a rate of three chambers per month. Anode electronics for ME1/1 is on the production stage. Delivery of cathode electronics was started in October, 2002. Work on integration of the ME1/1 zone is continued with a full-scale mock-up.

The mass-production of silicon radiation hard detectors (sensors) [25] for SE is on schedule in cooperation with RIMST, Zelenograd. The radiation study of the Si-strip detectors is continued. Dubna regional centre is prepared for detector-module assembly.

JINR physicists participate in the RDMS CMS task force on the development of software and simulation of physics processes with emphasis to endcap and forward region. The research programme of the physics processes with hard muons ($p_T > 300$ GeV) in the final state was started. These studies include the following topics: production of the additional gauge bosons, horizontal gauge bosons, and double-charged Higgs bosons; search for signals of formation of the heavy graviton resonances and other manifestations of extra dimensions. Based on the simulation of the new gauge bosons production, a potential of the CMS detector system for Z' discovery was demonstrated. The studies within the CMS Heavy Ion programme have been continued. The possibility of the quark-gluon plasma formation in the light nuclei central interactions and in the noncentral

collisions of the heavy nuclei was shown. The influence of the secondary interaction processes and parton shadowing effect on the A -dependence of the particle multiple production was studied. The SIMUB package for simulation of B -meson production and decays has been developed [26] in Dubna. This physics generator has been incorporated in general CMS simulation software. About 20 million Monte-Carlo events of the so-called CMS golden decay $B_s^0 \rightarrow J/\psi\phi$ have been produced in Dubna to study the exclusive B trigger and estimate the precision of decay parameters determination from the data. The study of direct gamma production is being continued [27]. The hadron calorimeter response of combined HE/HF system was simulated.

LPP takes part in the construction and commissioning of Barrel Electro-Magnetic Calorimeter (BEMC) systems for the 4π detector **STAR** for the RHIC collider at the Brookhaven National Laboratory (BNL). About 10% of the BEMC modules have been completed and tested in Au-Au and pp collisions. The LPP group participates in the development of the BEMC Software and physics programme for further studies at the STAR detector. In particular, the LPP group has proposed a dedicated experiment at the STAR detector to study the soft photons in the energy range from 20 to 100 MeV.

The NIS project is aimed at measuring the cross sections of the near-to-threshold ω and ϕ production in pp and np interactions at the JINR Nuclotron to search for OZI-rule violation as manifestation of the polarized intrinsic strangeness of nucleons. To match these tasks, it was proposed to implement in the SPHERE set-up three proportional chambers of 2×1 m in size from the EXCHARM set-up, as well as a new charge Particle Identification (PID) system based on measurements of their time of flights and momenta. The proportional chambers were refurbished, tested at the EXCHARM test-bench and transported from Protvino to Dubna. Several prototypes of counters for PID and the trigger system have been manufactured.

ACCELERATION TECHNIQUES

In accordance with the schedule of operations for the **LHC Damper** project, the 2002 activities were focused on the design and manufacturing of the electrostatic kickers and power amplifiers of the Transverse Oscillation Damping System (TODS) for LHC as well as on the investigations of the power amplifier circuit and damping regimes for future upgrade of TODS.

During 2002, the Free Electron Laser (FEL) group continued the experimental and theoretical investigations of the millimeter-wave Free Electron Maser os-

cillators as possible microwave power sources for the linear collider **CLIC** at CERN.

Main fields of contributions from JINR to the **TESLA** project are X-ray FEL, $\gamma\gamma$ -collider option, and participation in the accelerator and FEL experiments at the TESLA Test Facility (TTF) at DESY. Phase I of TTF FEL project has been successfully executed. Project parameters have been exceeded significantly [28]. Equipment for Regenerative FEL Amplifier has been installed and tested with the electron beam and

radiation in the TTF tunnel [29]. The theoretical and design studies in accelerator and FEL physics involve the following topics: optimization of the user facility at TTF and X-ray FEL Laboratory [30], FEL schemes providing femtosecond and attosecond-scale pulse duration [31], study of beam physics [32]. A conceptual study of Far Infrared Radiator at the TTF is in progress [33]. Implementation of this device would allow for a powerful source (up to 100 MW peak power) in the THz frequency band. Application of Thomson backscattering would permit an intensive, polarized, monochromatic X-ray source with femtosecond-scale pulse duration.

A new, nontraditional direction in technique of the **electron accelerators for radiation technologies** is being developed at LPP. The D-300-10 accelerator, which is meant to be used for vulcanization of a latex, has been manufactured and delivered to Japan. The parameters of the accelerator are: energy — 300 keV, average beam current — 34 mA, beam power — 10 kW. Development and manufacture of systems and units of the model of 700-keV accelerator have also been continued.

The detailed time-tables for realization of the **IREN** programme were prepared at FLNP and LPP together with outer partners involved in the project. The plans for the linac LUE-200 construction were fulfilled in the part implemented by JINR Laboratories. A very difficult problem of design and provision of necessary drawings for manufacture of elements of the LUE-200 accelerator was solved by designers of LPP and FLNP. A construction of many parts of magnetic focusing system and a linac girder was started and partly completed. Successfully was carried out a 10-day run of the LUE-200 modulator with a klystron at planned level of RF power. All elements of RF feeder were tested and adjusted. A technical design of the LUE-200 control system was completed and a part of involved equipment was delivered to test some elements of this system used in a full-scale RF stand. Two first coils for a solenoid of magnetic focusing system were manufactured at LPP. The stands for precise magnetic measurements were prepared at LPP and DLNP. Many elements of the vacuum system were tested and prepared by LPP experts for future use inside of LUE-200.

REFERENCES

1. *Potrebenikov Yu. K.* // Part. & Nucl. 2002. V. 33. P. 617.
2. *Aleev A. N. et al.* JINR Preprint D1-2001-283. Dubna, 2002;
Goudzovski E. A., Guriev D. K. // Proc. of the XV Intern. Conf. on High Energy Physics Problems, Dubna, 2001. V. 1. P. 298.
3. *EXCHARM Collaboration* (presented by O. V. Bulekov) // Proc. of the III Russian Conf. «University of Russia — Fundamental Investigations. Particle and Nuclear Physics», Moscow, 2002. P. 136.
4. *EXCHARM Collaboration* (presented by I. A. Polenkevich) // Ibid. P. 139.
5. *Kekelidze V. D.* // Part. & Nucl. 2002. V. 33. P. 626.
6. *Batley J. R.* // Phys. Lett. B. 2002. V. 544. P. 97.
7. *Lai A. et al.* // Ibid. V. 537. P. 28.
8. *Lai A. et al.* // Ibid. V. 533. P. 196.
9. *Lai A. et al.* // Ibid. V. 536. P. 229.
10. *Nagaitsev A. et al.* HERMES Internal Report 02-046, DESY. Hamburg, 2002.
11. *Airapetian A. et al.* // Phys. Lett. B. 2002. V. 535. P. 85.
12. *Airapetian A. et al.* DESY Preprint 02-137. Hamburg, 2002.
13. *Kapishin M. N.* // Part. & Nucl. 2002. V. 33. P. 641.
14. *Belkov A. A., Golutvin I. A., Kiryushin Yu. T.* // Ibid. P. 648.
15. *Belkov A., Moshkin A., Ososkov G.* HERA-B Note 02-067. Hamburg, 2002;
Belkov A., Fominykh B., Zaitsev Yu. HERA-B Note 02-036. Hamburg, 2002;
Belkov A. A. et al. // Part. Nucl., Lett. 2002. No. 2[111]. P. 51;
Abyzov A. et al. // Ibid. P. 5;
Albrecht H. et al. HERA-B Note 02-121. Hamburg, 2002.
16. *Belkov A., Shulga S., Shulga S.,* // HERA-B Note 02-081. Hamburg, 2002.
17. *Abt I. et al.* DESY Preprint 02-076. Hamburg, 2002.
18. *Abt I. et al.* DESY Preprint 02-187. Hamburg, 2002.
19. *Zaimidoroga O. A.* // Part. & Nucl. 2002. V. 33. P. 673.
20. *Back H. O. et al.* JINR Preprint E1-2002-29. Dubna, 2002.
21. *Back H. O. et al.* JINR Preprint E1-2002-30. Dubna, 2002.
22. *Leroy C. et al.* ATLAS Intern. Note, ATL-LARG-2002-003, CERN. Geneva, 2002.
23. *Dowler B. et al.* // Nucl. Instr. Meth. A. 2002. V. 482. P. 94.
24. *Golutvin et al.* CMS NOTE-2002/013, CERN. Geneva, 2002.
25. *Evangelou I. et al.* CMS NOTE-2002/026, CERN. Geneva, 2002;
Bloch Ph. et al. // Nucl. Instr. Meth. A. 2002. V. 479. P. 265;
Bloch Ph. et al. // IEEE Transactions on Nucl. Sci. 2002. V. 49, No. 1.
26. *Belkov A. A., Shulga S. G.* // Proc. of the 6th Intern. School-Seminar on Actual Problems of High-Energy Physics, Gomel, Belarus, Aug. 7–16, 2001; hep-ph/0201283. Jan. 2002. 16 p.
27. *Konopliyanikov V. et al.* CMS IN-2002/014, CERN. Geneva, 2002.

28. *Yurkov M. V.* // Nucl. Instr. Meth. A. 2002. V. 483. 2002. P. 51;
Ayvazyan V. et al. // Phys. Rev. Lett. 2002. V. 88. 2002. P. 10482;
Ayvazyan V. et al. // Eur. Phys. J. D. 2002. V. 20. P. 149.
29. *Faatz B. et al.* // Nucl. Instr. Meth. A. 2002. V. 483. P. 412.
30. *Feldhaus J. et al.* DESY Preprint 02-026. Hamburg, 2002.
31. *Saldin E. L., Schneidmiller E. A., Yurkov M. V.* // Optics Commun. 2002. V. 202. P. 169; V. 205. P. 385; V. 212. P. 377;
Brefeld W. et al. // Nucl. Instr. Meth. A. 2002. V. 483. P. 62, 75, 80.
32. *Saldin E. L., Schneidmiller E. A., Yurkov M. V.* // Nucl. Instr. Meth. A. 2002. V. 483. P. 516.
33. *Brefeld W. et al.* DESY Preprint 02-038. Hamburg, 2002.

DZHELEPOV LABORATORY OF NUCLEAR PROBLEMS

LOW- AND INTERMEDIATE-ENERGY PHYSICS

In 2002 the assembly and tuning of the **NEMO-3** spectrometer, which is designed to investigate the double beta decay of a set of isotopes ^{100}Mo (7.2 kg), ^{82}Se (1 kg), ^{116}Cd (0.6 kg), ^{130}Te (1.3 kg), ^{150}Nd (48 g), ^{96}Zr (20 g), ^{48}Ca (10 g), were finished in the underground laboratory LSM (Modane, France). With the

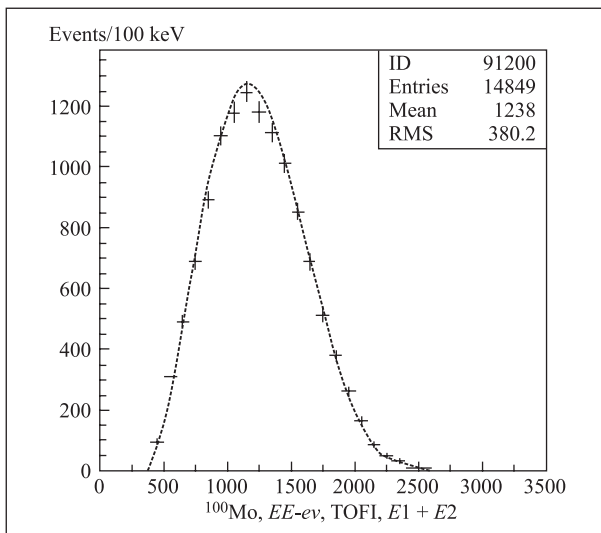

Fig. 1. Integral ^{100}Mo $2\nu2\beta$ spectrum collected during 700 hours of data taking with completely mounted NEMO-3 set-up

NEMO-3 set-up after several years of measurement it is planned to reach sensitivity for neutrinoless double beta decay of ^{100}Mo at the level of $T_{1/2}(0\nu2\beta) \sim 5 \cdot 10^{24}$ y, which corresponds to 0.1–0.4 eV level in terms of Ma-

jorana neutrino mass. Scintillator and geiger parts of the spectrometer were tuned and energy and time calibrations were performed during spring 2002, before the detector was started to take data on 12 June 2002. Data collection in parallel with the further tuning and improvement of the spectrometer's characteristics were carried out during autumn 2002. Preliminary analysis of first portion of data (Fig. 1) allowed the following results for ^{100}Mo to be obtained: $T_{1/2}(2\nu2\beta) = 0.8 \pm 0.008(\text{stat.}) \pm 0.150(\text{syst.}) \cdot 10^{19}$ y; $T_{1/2}(0\nu2\beta) > 1.2 \cdot 10^{23}$ y (90 % C.L.) and $T_{1/2}(0\nu2\beta\chi^0) > 6.4 \cdot 10^{21}$ y (90 % C.L.).

A new low-background spectrometer **TGV-2** with high efficiency was created from construction materials of very low level of radioactive impurities. The spectrometer is intended for the investigation of rare nuclear processes: $2\beta2\nu$, $2\beta0\nu$ decays of ^{48}Ca , and $2K2\nu$, $2K0\nu$ decays of ^{106}Cd . The spectrometer is based on 32 planar type HPGe detectors with a total sensitive volume of about 400 cm^3 (about 3 kg of Ge) and consists of a cryogenic system, an electronic scheme of events registration, a passive shielding and methods of active suppression of various components of natural background. The TGV-2 spectrometer was mounted in the Modane underground laboratory (4800 m w. e.), France.

Measurements with an external source of 24.6 g of enriched $^{48}\text{CaF}_2$ (about 10 g of ^{48}Ca) were performed during 1590 hours and new limits on β^- decay of $^{48}\text{Ca} \rightarrow ^{48}\text{Sc}$ and $\beta^-\beta^-$ decay of ^{48}Ca to excited states of ^{48}Ti were obtained. The limits for β^- decay to the 6^+ ground state, excited 5^+ and 4^+ states in ^{48}Sc are $1.6 \cdot 10^{20}$, $2.5 \cdot 10^{20}$ and $1.9 \cdot 10^{20}$ y at the 90 % C.L. For the $\beta^-\beta^-$ decay to ^{48}Ti the limits to the first

2^+ , second 2^+ and first 0^+ excited states are $1.8 \cdot 10^{20}$, $1.5 \cdot 10^{20}$ and $1.5 \cdot 10^{20}$ y at the 90% C. L. [1].

In 2002 investigations of the ^{221}Fr excited states structure at the decay of ^{225}Ac were completed. Much more precise information on the α and γ spectra and the level structure of ^{221}Fr was obtained in $(\alpha-\gamma)$ -coincidence experiments. On this basis the ^{221}Fr level scheme has been proposed and conclusions on spin and parities and other properties of the proposed states have been made. A good agreement was revealed between the experimental data and the calculation carried out in the framework of Solovjev's quasiparticle phonon nuclear model without assumption on static octupole nuclear deformation [2].

In connection with recent claim of the first evidence for neutrinoless double beta decay in Ge [3] an analysis of γ spectrum near $Q_{2\beta 0\nu}(^{76}\text{Ge}) = 2039$ keV has been started in order to make interpretation for observed γ lines. It can be assumed that this peak in the spectrum

could appear at the decays of ^{77}Ge or/and ^{76}Ga , which are formed at neutron and/or μ -meson capture in the detector material. In this case there is explanation for the yet unidentified background γ peaks at $E_\gamma \approx 2070$ keV.

In the framework of the **AnCor** project, on the muon beam of PSI accelerator (Villigen, Switzerland), the investigation of the angular γ -neutrino correlation in μ capture of ^{16}O was finished. The necessity of this investigation on the muon beam is explained by the peculiarity of the nucleus. The extreme low density of the target is required to avoid deceleration of recoil nucleus.

As the data obtained contradicted to the Standard Model of the electroweak interaction and demonstrated the presence of the scalar interaction, the experiment was repeated on the other target. The measuring of the γ spectrum accompanying the μ capture for the neon at the atmosphere pressure was performed (Fig. 2).

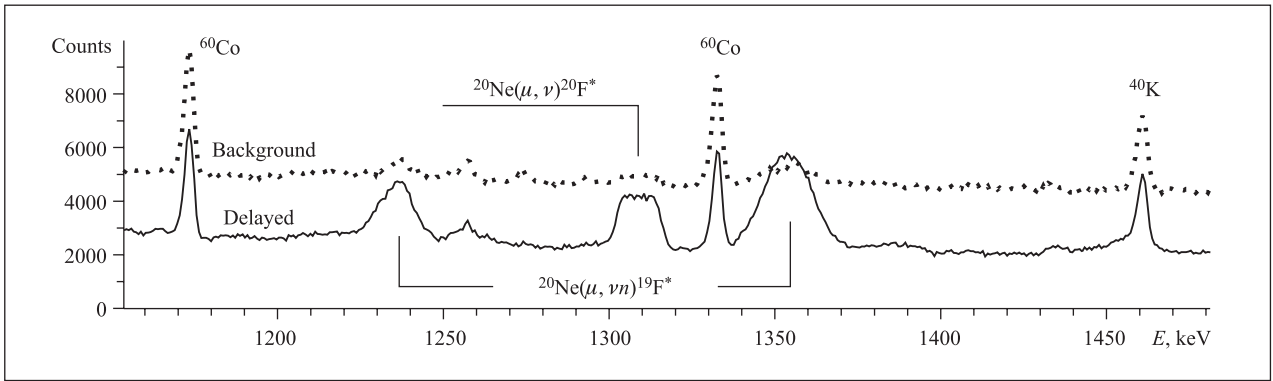

Fig. 2. Part of the γ spectrum for the Ne nucleus

The lines of the three kinds are presented: narrow background lines, which do not change their intensity with time, Doppler triangle-like lines which correspond to the μ capture with neutron emission, and rectangle-like line that corresponds to the process. From the analysis of the line's form the information about form factor of the scalar and pseudoscalar interactions will be obtained [4].

The test measurements with the targets from B, C, Mg, Si, S, Ar and Ca were performed simultaneously with the measurements of the γ -line form at μ capture in ^{16}O and ^{20}Ne .

Under the **LESI** project, measurements are performed of the ion energy distribution in a deuterium liner accelerated in the inverse Z -pinch, in which the plasma is accelerated electro-dynamically from the liner axis. The knowledge of the deuteron energy distribution is of primary importance for the correct interpretation of the experimental results from the study of the dd reaction in the range of ultra-low energies with the use of liner plasma. Experiments were carried out in a high-

current pulsed accelerator ($I = 950$ kA, $\tau = 80$ ns) at the Institute of High-Current Electronics of the Siberian Division of the Russian Academy of Sciences (Tomsk, Russia). In the initial state, the liner is a supersonic hollow deuterium jet 32 mm in diameter and 20 mm in length. The liner parameters were measured with the help of optical detectors of H_α and H_β deuterium lines and magnetic probes arranged in the radial direction (along the direction of the liner expansion). In addition, scintillation spectrometers and ^3He counters were used to measure the intensity of the neutron flux produced in the $d+d \rightarrow ^3\text{He}+n$ reaction. The results obtained by simultaneously analysing the data from magnetic probes, optical detectors, and neutron detectors point to the possibility of using a rather simple method for measuring the parameters of the liner accelerated up to energies of 3–6 keV [5].

The mesonless deuteron break-up $p+d \rightarrow p+p+n$ at high momentum transfer is studied with the **ANKE** spectrometer at the internal beam of the proton synchrotron COSY (Jülich). Such a reaction in the collinear

geometry with a backward emission of a fast nucleon presents a simplest cumulative process, and its study, with complete reconstruction of the event kinematics, is of significant interest to elucidate the mechanisms of these processes. The ANKE collaboration has obtained the data on the break-up with emission of a pair of fast protons with low energy E_{pp} of the relative motion in the pair. The pairs are emitted at small angles to the direction of the proton beam. The break-up differential cross section, integrated over $E_{pp} < 3$ MeV and averaged over the pair ejection polar angle from 0 to 8° , was determined. The obtained cross sections decrease with increase of the proton beam energy (which is varied from 0.6 to 1.9 GeV) in the same way as the proton–deuteron backward elastic scattering $pd \rightarrow dp$ cross section does, but the values are two orders of magnitude less [6].

In 2002, search for the radioactive capture $d + d \rightarrow {}^4\text{He} + \gamma$ reaction from the $dd\mu$ muonic molecule state was performed at the **muon beam of the JINR Phasotron** with a high-pressure deuterium target (Fig. 3).

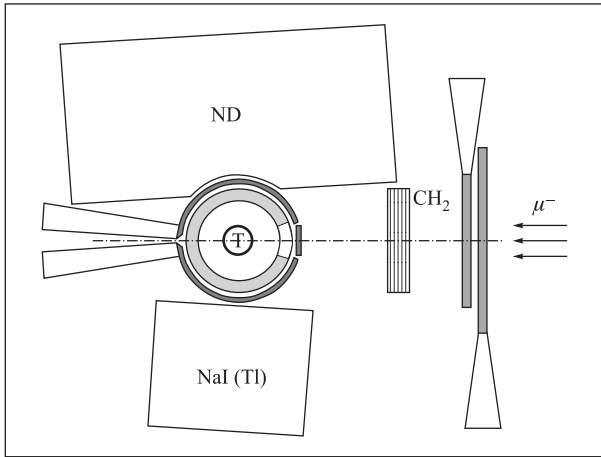

Fig. 3. Experimental layout for the radioactive capture $d + d \rightarrow {}^4\text{He} + \gamma$ reaction

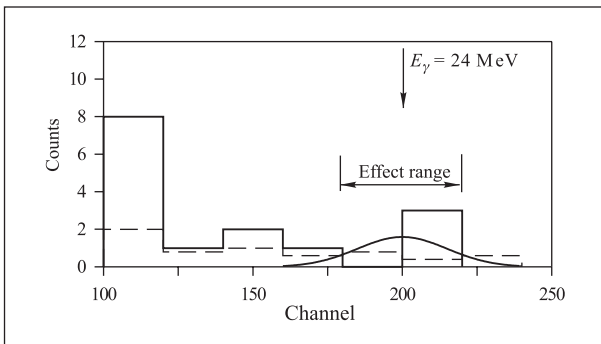

Fig. 4. Amplitude γ -quanta spectra in NaI detector. Response function of the NaI detector is represented by the gaussian

The deuteron radioactive captures reaction in the $dd\mu$ molecule $dd\mu \rightarrow {}^4\text{He}\mu + \gamma + 23.8$ MeV has not previ-

ously been investigated because of the extreme smallness of its expected yield. At temperatures $T > 150$ K the $dd\mu$ molecules are mainly formed in the $J = 1$ state, and fusion reactions proceed from the p wave of relative nuclear motion. Therefore, being detected, the 23.8-MeV γ quanta would unambiguously indicate a finite p -wave contribution into the process. The search for γ quanta was performed. On the basis of the data obtained (Fig. 4) the measured yield of the reaction $dd\mu \rightarrow {}^4\text{He}\mu + \gamma + 23.8$ MeV per $dd\mu$ molecule is evaluated to be (at 90% C.L.) $\eta_\gamma < 2 \cdot 10^5$. The upper limit for the radioactive fusion rate from the $J = 1$ state of $dd\mu$ molecule is $\lambda_\gamma^1 < 8 \cdot 10^3$ s $^{-1}$ [7].

In 2002 the study of the condensed matter by the μSR technique was continued under the DLNP project **MUON** (investigation of the muon properties and the muon interactions with matter). The experiments with silicon were aimed to investigate the effect of impurities on the relaxation rate of the magnetic moment of the shallow acceptor centre. The measurements were carried out on more than 20 silicon samples with p and n impurities of different concentrations. The constant of the hyperfine interaction of the Al shallow acceptor centre in undeformed silicon is determined for the first time: $A/h(^{27}\text{Al}) = (-2.2 \pm 0.2)$ MHz. It was found that the hyperfine interaction in the shallow acceptor centres is weaker than that in the donors. This fact supports the idea about significant input of the p wave into the wave function of the ground state of the acceptor impurity. The temperature dependence of the relaxation rate of the shallow acceptor centre in undeformed silicon is determined for the first time for the impurity concentration from $\sim 5 \cdot 10^{12}$ to 10^{20} cm $^{-3}$ and temperatures of 4.2–50 K. In degenerate silicon the relaxation by spin-exchange scattering of «free» charge carriers on the acceptor dominates at $T < 30$ K. The effective cross sections for the spin-exchange scattering of holes (σ_h) and electrons (σ_e) on the Al acceptor in Si are estimated to be $\sigma_h \sim 10^{-13}$ cm 2 , $\sigma_e \sim 8 \cdot 10^{-15}$ cm 2 , respectively [8].

In 2002 the data treatment of the pion beta-decay statistics was continued under the JINR project **PIBETA** (precise measurement of the pion beta-decay rate). Data taking was completely finished in 2001. At the first phase of the PIBETA experiment, about two orders of magnitude larger statistics (comparing with entire world data) have been recorded for the rare pion and muon decays. For the pi-beta decay ($\pi \rightarrow \pi^0 e \nu$) the PIBETA data set counts more than 50 K events, while previously available data were only 1.77 K events. For the $\pi \rightarrow e \nu$, $\pi \rightarrow e \nu \gamma$ and $\mu \rightarrow e \nu \nu \gamma$ decays the PIBETA collaboration has more than 580 M, 60 K and 500 K events, respectively, while only 0.35 M, 1.35 K and 8.5 K events were available before the PIBETA experiment started. The current result for the pion beta-decay branching ratio is $1.044 \pm 0.007(\text{stat.}) \pm 0.009(\text{syst.}) \cdot 10^{-8}$.

The statistics of about 15000 radioactive pion decays $\pi \rightarrow e\nu\gamma$ was treated in 2002. The data were recorded simultaneously with the beta-decay statistics. Part of the radioactive pion decay statistics was taken with the trigger proposed by Dubna group. The preliminary analysis of the radioactive pion decay shows a small admixture of the tensor weak interaction, which is forbidden in the SM. The comprehensive investigations of any source of the possible errors or inefficiencies in the analysis routines are under way [9].

Under the joint JINR–INFN project **DUBTO**, aimed at the investigation of pion-nuclear interactions at energies below the Δ resonance, the experimental set-up **STREAMER** was created. The set-up is a self-shunted streamer chamber, filled with helium. The chamber is situated in a magnetic field and is equipped with two CCD video cameras for the registration of events of nuclear reactions within the volume of the streamer chamber. The chamber serves simultaneously as a thin target and a triggerable track detector, which makes it possible to study π^\pm ^4He reactions, for which measurement is required of the complete kinematics of slow charged secondary particles. The beam parameters and the parameters of the data acquisition system permitted over 5000 stereo images of pion interactions with helium nuclei to be collected at a pion beam momentum of 206 MeV/c [10].

Measurements of the reaction $\pi^+{}^4\text{He} \rightarrow \pi^+2p2n$ have permitted one to identify over 100 events which satisfy the final state interaction condition for the two neutrons, and for which the distribution of πNN invariant masses exhibits the same resonance behaviour as the distribution obtained in a study of proton–proton interaction at 920 MeV at ITEP [11], and has a maximum in the region of 2.05 GeV. Most likely, this resonance be-

haviour is related to the known d' resonance. Another physical result obtained is the first observation of the bremsstrahlung of positive pions on helium nuclei. The branching ratios for different reaction channels were obtained and the data (Fig. 5) are presented in the table

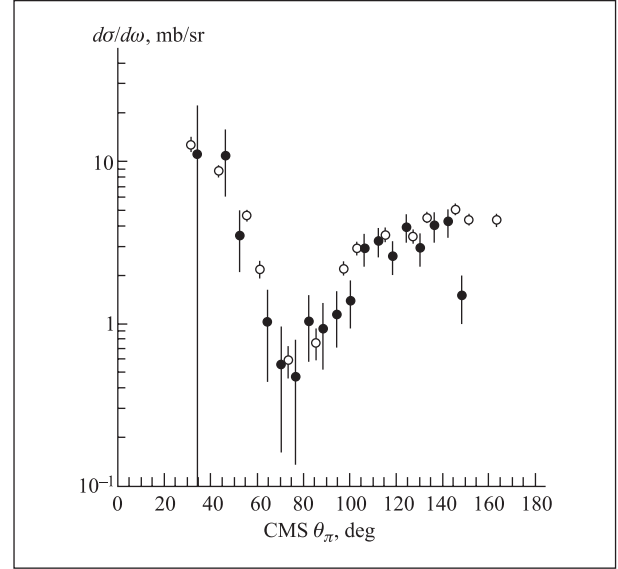

Fig. 5. The angular distributions of elastic $\pi^+{}^4\text{He}$ -scattering differential cross sections (channels 1 and 2) measured with the diffusion chamber technique and with the streamer chamber technique, respectively. Full circles — data obtained in 2002; empty circles — data obtained in 1980

together with the only existing data for processes (1), (3) and (4), obtained in 1980 with the aid of a diffusion cloud chamber [12].

Probability branching ratios for two-prong $\pi^+{}^4\text{He}$ -interaction processes

| Reaction | 1980, diffusion chamber | 2002, streamer chamber |
|---|-------------------------|-----------------------------------|
| $\pi^+{}^4\text{He} \rightarrow \pi^+{}^4\text{He}$ (1) | 0.588 ± 0.076 | $0.380 \pm 0.021 + 0.049 - 0.043$ |
| $\pi^+{}^4\text{He} \rightarrow \pi^+{}^4\text{He}\gamma$ (2) | — | $0.322 \pm 0.019 + 0.112 - 0.026$ |
| $\pi^+{}^4\text{He} \rightarrow \pi^+{}^3\text{He}n$ (3) | 0.240 ± 0.038 | $0.136 \pm 0.013 + 0.025 - 0.018$ |
| $\pi^+{}^4\text{He} \rightarrow \pi^0{}^4\text{He}p$ (4) | 0.176 ± 0.053 | $0.162 \pm 0.014 + 0.000 - 0.000$ |

In 2002 under the project «**Aerogel**» an improvement of qualitative parameters of silicon dioxide aerogel samples (transparency, hydrophobic behaviour, etc.) was obtained. Characteristics of the $n = 1.04$ aerogel were studied in the accelerator experiment carried out together with L. S. Zolin's group (VBLHE) by comparing samples of diameters 75 and 125 mm made for this experiment at DLNP with samples made in Japan and Novosibirsk. The experiment revealed quite good agreement of the characteristics. An instrument for sample quality control (detection of microcracks, bub-

bles, and other inhomogeneities) is designed and built. The system for drying samples in the 37-l autoclave is automated.

During the year, efforts were made to develop a technology for production of large-size aerogel samples with a low refractive index ($n = 1.008$) by using the available equipment and instrumentation. Small samples of low quality (cracks, poor transparency, very large shrinkage at drying) were produced. The problem can be solved by using CO_2 for drying samples, but this requires development of new equipment [13].

HIGH ENERGY PHYSICS

The JINP group of the **DELPHI** collaboration has studied the production of tau pairs in collisions of quasi-real photons in the reaction $e^+e^- \rightarrow e^+e^-\tau^+\tau^-$. An integrated luminosity 650 pb^{-1} collected by the DELPHI detector during 1997–2000 LEP running has been analyzed. The tau pairs were identified using the topology in which one tau decays into an electron, while the other tau decays into a particle other than electron. Both decay modes were identified using the dE/dx losses measured by the DELPHI tracking system. The average LEP2 cross section was found to be $(441 \pm 17) \text{ pb}$, which is in very good agreement with the Standard Model prediction of 448 pb. The measured cross section was used to set upper limits on anomalous magnetic moment a_τ and electric dipole moment d_τ of the tau lepton: $-0.029 < a_\tau < 0.013$ and $|d_\tau| < 3.3 \cdot 10^{-16} \text{ electron} \cdot \text{cm}$. The a_τ limit obtained is better than the current PDG value [14].

The JINR group involved in the **NOMAD** (Neutrino Oscillation MAGnetic Detector, WA96) experiment is responsible for the analysis of strange particle production in neutrino interactions. In 2002 the

integral yields of neutral strange particles in $\nu_\mu\text{CC}$ interactions were measured with several times better precision than previously: (6.76 ± 0.06) , (5.04 ± 0.06) and $(0.37 \pm 0.02) \%$ for K_s^0 , Λ^0 , anti- Λ^0 , respectively. Large discrepancies between the NOMAD data and the predictions of the LUND model with default parameters for the description of the strange resonance and heavy hyperon production in neutrino interactions have been observed. For example, for the ratio $N(\Sigma^{*+})/N(\Lambda)$ the LUND model predicts $(17.0 \pm 0.6) \%$, while the NOMAD data show $(5.2 \pm 1.0) \%$. New results combined with previous NOMAD measurements of the Λ^0 and Λ^{-0} polarization in $\nu_\mu\text{CC}$ interactions have been used for theoretical attempts to improve the model of polarized strangeness in the nucleon. It is shown that at moderate energies (NOMAD, COMPASS) the tail in the $x_F > 0$ region for Λ^0 distribution from the diquark fragmentation overlaps the Λ^0 x_F -distribution from the struck-quark fragmentation (Fig. 6, *a*). The situation changes drastically for the neutrino experiments, if the beam energy is increased to 500 GeV (Fig. 6, *b*) [15].

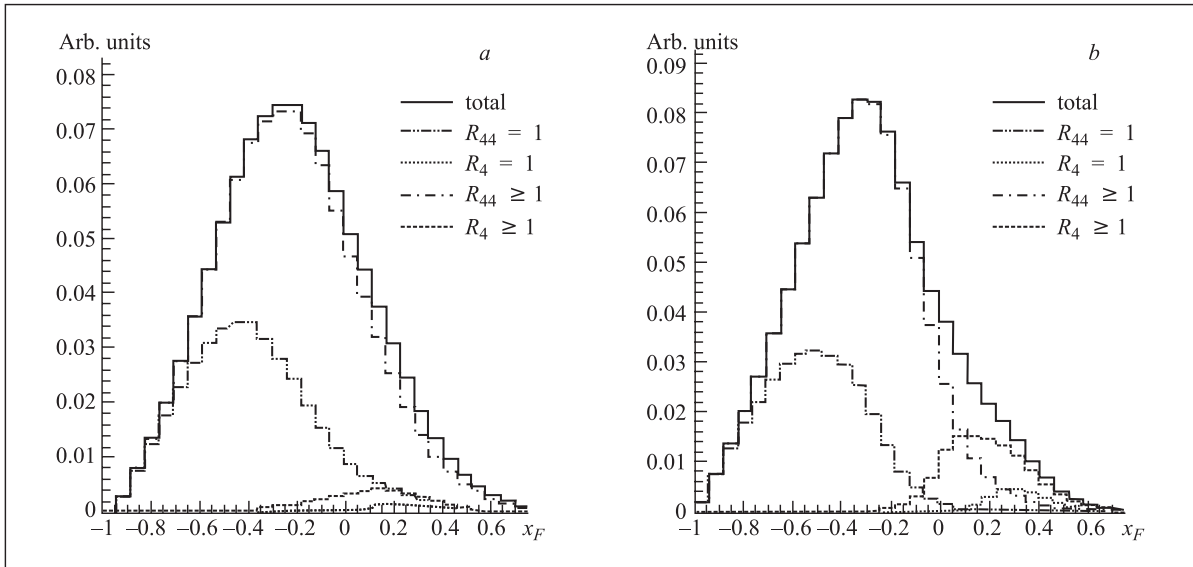

Fig. 6. Predictions for the x_F distribution of all Λ hyperons (solid line), of those originating from diquark fragmentation and of those originating from quark fragmentation, for the two model variants A and B, as explained in the legend on the plots. The plot *a* is for $\nu_\mu\text{CC}$ DIS with $E_\nu = 43.8 \text{ GeV}$, and the plot *b* is for $\nu_\mu\text{CC}$ DIS with $E_\nu = 500 \text{ GeV}$

The study of hadron production for the neutrino factory and for the atmospheric neutrino flux (**HARP**, PS214 experiment at the CERN PS) was continued. In 2002 the HARP was approved for 140 days of running, and the measurement of the secondary hadrons,

produced by proton and pion beams in the momentum range from 1.5 to 15 GeV/c, was carried out at CERN's 28-GeV PS. The measurements were fulfilled for different targets from hydrogen to lead. Additional measurements were performed for targets of the K2K and

MiniBooNE experiments and also for water target; the last HARP experiment can shed light upon the uncertainty in the background to the anomalous anti- ν_e signal observed in the LSND experiment. A total of 25 Tbytes of raw data were written, and the data analysis is under way.

In 2002, main results of the JINR group involved in the **CDF** experiment at Tevatron are the following. A new set of scintillating counters was installed and included in the CDF upgraded muon trigger system. The system was used in current data-taking run for selection of events with heavy quarks. A slow control software was created for monitoring and control of muon scintillating counters HV power supply. This complex was integrated into general CDF slow control system and successfully used during Run-II data taking. A software package was developed for unique Silicon Vertex Tracker (SVT) based on fast associative memory technology. The SVT uses information from CDF silicon strip detectors and is the important part of the Level-II trigger with a decision time of 14 μ s. It allows three-order-of-magnitude background reduction. The SVT is used for fast second vertex recognition, which is very important for selecting b -quark events. This system is being used for « π - K - p » separation in B -meson studies ($B\bar{B}$ mixing and CP -violating decay modes). A new software was prepared and data analysis was started with $p\bar{p} \rightarrow$ leptons + jets channel for precise measurement of top-quark mass and its production cross section [16].

The JINR group involved in the **D0** collaboration is responsible for the support and development of the Mini-Drift Tubes (MDTs) and corresponding front-end electronics of the D0 experiment. It is also

at D0 has developed a new selection criterion for events with an associated production of hadronic jets and the direct photons or Z bosons, which allows the precision of setting absolute jet energy scale for the D0 experiment to be improved essentially. A new requirement of a jet isolation, introduced for the first time, allows one to select topologically clean «photon/ $Z0$ + jet» events, which would provide almost 1% accuracy of the absolute jet energy scale determination.

The direct inclusive photon spectrum measured with the D0 set-up is demonstrated in Fig. 7. The experimental data fit well with QCD(NLO) theoretical calculations. Among the data from this sample there is a subsample of «direct photon + jet» events. The behaviour of the «direct photon + jet» events cross section is shown below the direct photon curve in Fig. 7. Both curves are based on the results of preliminary analysis that shows a good agreement with Run-I data in the p_T region where the data overlap.

In 2002 a new direction of fundamental research (astrophysical studies on space satellite) was started at JINR. The **TUS** space experiment was proposed to address some of the most important astrophysical and particle physics problems. It will measure energy spectrum, composition and angular distribution of the Ultra High Energy Cosmic Ray (UHECR) at energies $E > 10^{19}$ eV to study the region of Greisen-Zatsepin-Kusmin cutoff. The active galactic nuclei, the collisions between galaxies and relativistic jets are one of the most probable UHECR sources. The UHECR existence puts a question about the alternative mechanism of their origin due to decays of the super-heavy dark matter particles, predicted by the modern theories [17, 18]. The TUS detector is supposed to locate on the Resyrs-O1 satellite with an orbit height of about 750 km above the Earth. The present time activity includes the R & D study of the Fresnel mirror prototype production based on the carbon plastic and space tests of the prototypes: Monte-Carlo simulation of the TUS detector properties (Fig. 8) and R & D software and hardware for on-board computing.

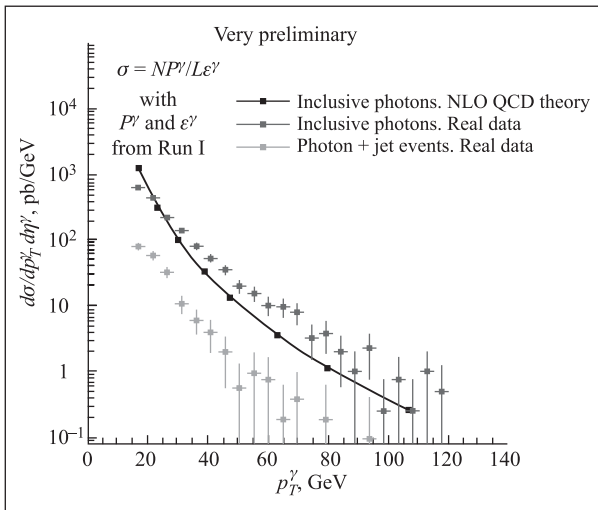

Fig. 7. The photon spectrum measured by the D0 set-up

expected that the group will participate in running the D0 detector, data taking and analysis. The JINR group

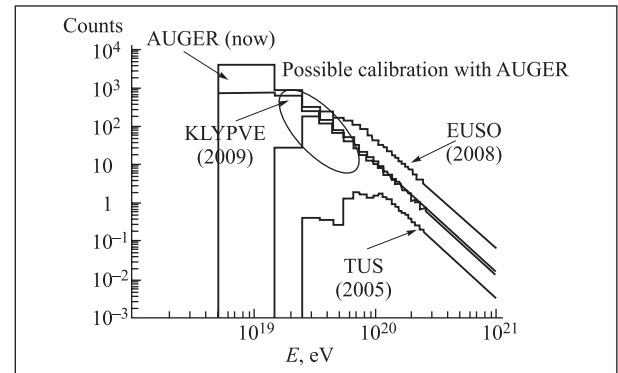

Fig. 8. Results of the Monte-Carlo simulation of UHECR study on the TUS and other space/ground-based detectors. Number of expected events per year bases on AGASA data

The TUS detector launch is planned for 2005–2006. The existing world statistics is supposed to be increased 2–3 times during three years of data taking. The detector allows the extensive air shower events caused by UHECR neutrinos to be measured for the first time from the space orbit. The experiment is included in the Russian Programme of Space Investigation and has to be designed, constructed, tested and launched to the space for data taking.

The **DIRAC** experiment is aimed to measure the lifetime of $\pi^+\pi^-$ atoms in the ground state with a 10 % precision using the 24 GeV/c proton beam of the CERN

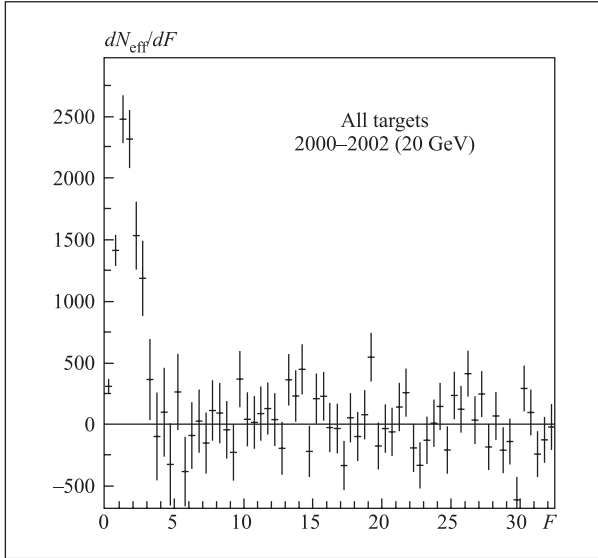

Fig. 9. Distribution of the difference between the detected number of $\pi^+\pi^-$ pairs and the number of the pairs produced in the free state over variable F which is related with the pair relative momentum Q as $F = \sqrt{(Q_x^2 + Q_y^2)/(1 \text{ MeV}/c)^2 + (Q_L/0.65 \text{ MeV}/c)^2}$. The excess of events in the range of small F is due to the pairs from the $\pi^+\pi^-$ -atom breakup in the target. The number of the detected «atomic» pairs in the interval of $F < 3$ is 9294 ± 640 . The distribution includes events detected in 2000–2001 with the Ni and Ti targets and a half of data obtained in 2002 with Ni target

Proton Synchrotron. As the value of the above lifetime of the order of 10^{-15} s is dictated by a strong interaction at low energy, the precise measurement of this quantity enables one to determine a combination of S -wave pion scattering lengths to 5%. Pion scattering lengths have been calculated in the framework of the chiral perturbation theory with a high precision. Thus, the accurate measurement of these values would put the understanding of chiral symmetry breaking of QCD to a crucial test.

In 2002 the new, third, plane of the scintillating fiber detector has been produced and implemented in the set-up to improve event selection accuracy; the total number of events taken with the nickel target is about 700 million; about 9200 $\pi^+\pi^-$ atoms have been

identified with the data obtained with the nickel and titanium targets (Fig. 9); a full-scale module of a micro-drift chamber with readout electronics has been produced and tested successfully on the beam [19].

The precision drift chambers (MDT) construction for the **ATLAS** muon system was continued at JINR. The quality of the muon measurement is one of the guiding design criteria for the ATLAS experiment. Muon spectrometer is the outer layer of the ATLAS detector (average dimensions: about 22 m high and 44 m long). For the muon trajectory reconstruction the determination of at least three points in the muon track is needed. Altogether it requires 5500 meters squared have to be covered by muon detectors or 400000 single drift tubes, grouped in 1200 chambers. Several types of coordinate detectors are used in the muon system. MDT detectors cover 98.6 % of full area of the ATLAS muon system.

The proposal to use the drift tubes with working gas overpressure was done by JINR group and, after first experimental confirmation, was selected by ATLAS as the main solution for coordinate detector for precision muon chambers (MDT). ATLAS has opted for a system of tubes (Monitored Drift Tubes chamber or MDT chamber) grouped in 1200 chambers. The construction of the muon spectrometer is such a big effort that it is shared between many laboratories in Russia, JINR, Germany, Italy, Holland and the USA. The JINR muon group is responsible for production of BMS-BMF chambers and drift tubes for BOS chamber (in cooperation with MPI, Munich) or for 20 % of total amount of ATLAS muon drift tubes. It is clear that the process of MDT chamber construction and test is naturally divided into two parts: 1) tube assembling (wiring) and test, and 2) MDT chamber assembling and test. The performance of the MDT muon system is determined by the operation of the drift tubes and, moreover, there is no possibility to replace/repair single elements of the muon chamber. Therefore, the process of tube wiring and testing must be strictly defined [20].

In 2002 the JINR muon group proceeded with drift tubes and muon chambers production and test. The BMS-type muon chamber has been produced at JINR and is ready for transport to CERN for X-ray quality test.

The high-precision assembly of large experimental set-ups like ATLAS is of a principal necessity for the successful execution of the forthcoming LHC research programme in the TeV beams. The creation of an adequate survey & control metrology methods is an essential part of the detector construction. The dimension measurement data for ATLAS hadron calorimeter module # 8 (6 m long, weighing 22 t) were obtained by laser and by photogrammetry methods. The comparative data analysis demonstrates the measurement agreement within $\pm 70 \mu\text{m}$ (Fig. 10) [21].

Hadron energy reconstruction for the ATLAS barrel prototype combined calorimeter, consisting of the

lead-liquid argon electromagnetic part and the iron-scintillator hadronic part, in the framework of the non-parametrical method was realized. The essential new feature of the method is that it uses only the known e/h ratios and the electron calibration constants and does not require the determination of any parameters by a minimization technique; therefore, this new method can be

used for the fast energy reconstruction in the first level trigger. The obtained reconstruction of the mean values of energies is within $\pm 1\%$ with respect to $\pm 2\%$ in the technical proposal. The results of the study of the longitudinal hadronic shower development are presented. The data have been taken in the H8 beam line of the CERN SPS using 10–300 GeV pions [22].

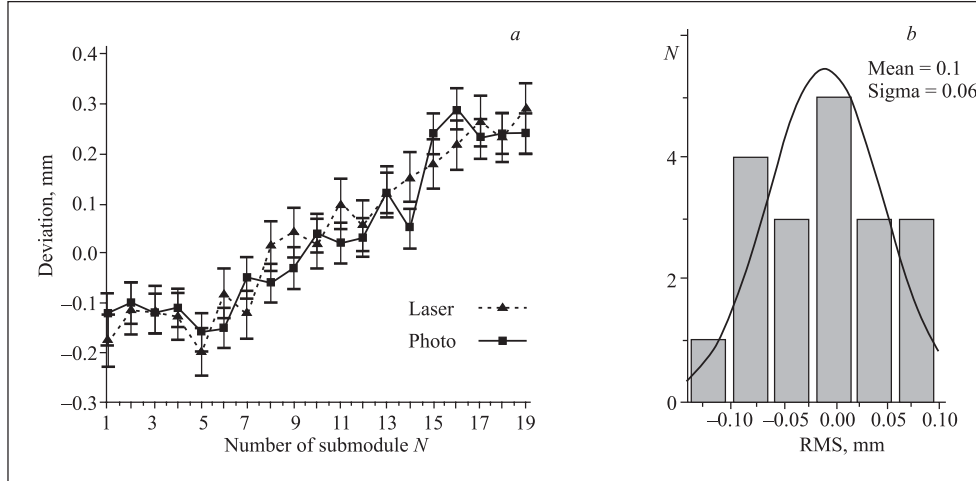

Fig. 10. Line Bell measurements data by the photogrammetric and laser methods after correction

RELATIVISTIC NUCLEAR PHYSICS

The scientific goal of the **FASA** project is the study of the thermal nuclear multifragmentation induced by the light relativistic ions in the heavy targets. This is a new multi-body decay process of the hot target spectator with the copious emission of the intermediate-mass fragments (IMF, $2 < Z < 20$). In previous studies of the FASA collaboration it was shown that this type of disintegration takes place after an expansion of the excited nucleus driven by the thermal pressure. The break-up density is $\rho_b \approx 0.3\rho_0$ (normal nuclear density) and the temperature is 5–7 MeV [23]. These findings correspond to the onset of the multifragmentation of nucleus entering the phase coexistence (spinodal) region. Due to the density fluctuations, a homogeneous system converts into a mixed phase, consisting of charged droplets (IMFs) surrounded by the nuclear gas. This is a «nuclear fog», which expands because of Coulomb repulsion. The time scale of this transformation should be very short.

The crucial point for the confirmation of this scenario is measuring the decay time of the fragmenting system for $p(8.1 \text{ GeV}) + \text{Au}$ collisions. That case is the most adequate for thermodynamic treatment of the process. It was done by the analysis of the relative

angle correlation of the intermediate-mass fragments [24]. The strong suppression of the yield of the frag-

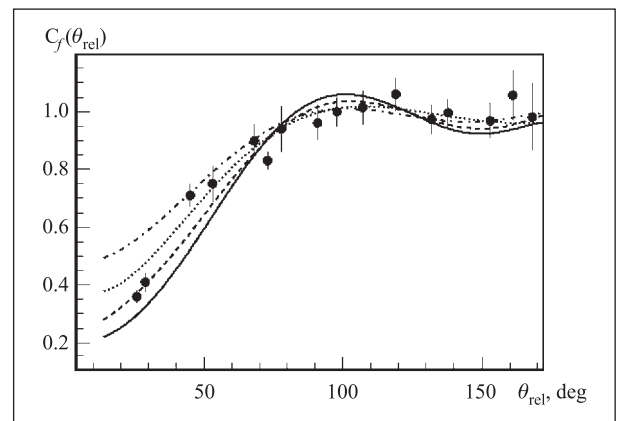

Fig. 11. Comparison of the measured correlation function (full circles) with the calculated ones for different mean decay times of the fragmenting system: solid, dashed, dotted and dash-dotted lines are for $\tau = 0, 50, 100$ and $200 \text{ fm}/c$. It is found from the best fit that $\tau = (50 \pm 18) \text{ fm}/c$ (90 % C.L.)

ment pairs at the small angles, caused by the IMF–IMF Coulomb repulsion, was observed (Fig. 11). Experimental correlation function (which is proportional to the IMFs yield) was compared to that obtained by the multi-body Coulomb trajectory calculations with various decay times τ of fragmenting system. The combined model, including the modified intranuclear cascade followed by the statistical multifragmentation model, was used to generate the starting conditions for these calculations. It was found that $\tau = (50 \pm 18)$ fm/c. Emphasis was put on the model dependence of the results obtained: a) two variants of the combined model have been used for which the properties of the fragmenting nuclei are different; b) dependence of the results on the instant of the secondary decay of the hot primary fragment was controlled; c) the sensitivity of the shape of correlation function to the size of the break-up volume was checked. It was found that the measured mean lifetime of the system is always $\tau \leq 70$ fm/c (Fig. 12).

The measured time scale is close to that for the density fluctuation in the diluted nuclear system. Therefore, the thermal multifragmentation can be interpreted as the first-order nuclear liquid–fog phase transition in the spinodal region [25].

APPLIED SCIENTIFIC RESEARCH

The aim of the Dubna–Kharkov–Moscow–Prague–Saclay joint project **PoLi** is the development of effective method of production ^6LiD irradiated materials for a big-volume polarized deuteron target with a high polarization (more than 40%). It is necessary to find the conditions of irradiation for optimum polarization build-up, maximum polarization value and relaxation time of nuclear polarization. The results of this project will be used on the polarized deuteron targets developed at JINR (movable polarized target at the Synchrotron–Nuclotron accelerator complex; Protvino target and the target of Charles University in Prague). To obtain the target material with high nuclear polarization, one has to define the optimum irradiation conditions (irradiation dose; temperature of the sample during irradiation; duration of irradiation, and energy of the beam particles).

In 2002 at DLNP during realization of this project a new irradiation device including cryostat and control panel was finished. The chemical box for working in N_2 atmosphere was manufactured. The system for the polarization measurement was modified and the development of the temper was completed.

In 2002, construction and test of general elements of magnetic and vacuum systems of the **LEPTA** set-up

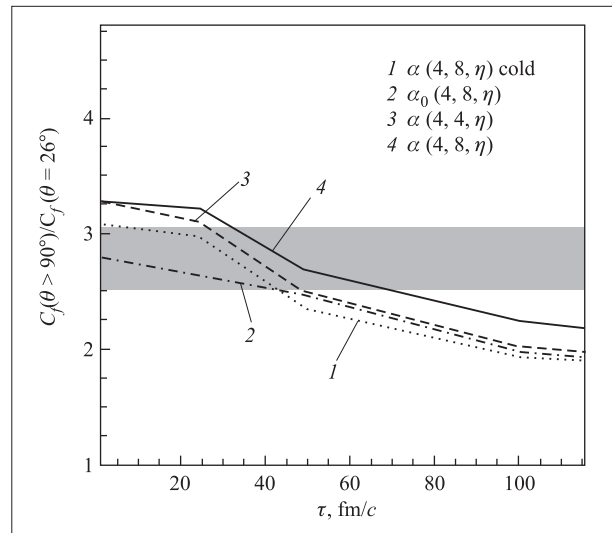

Fig. 12. Ratio of the correlation function at $\theta_{\text{rel}} > 90^\circ$ to that at $\theta_{\text{rel}} = 26^\circ$ versus the mean decay time of the system. The experimental value is given by the horizontal band, the lines are calculated using different model parameters. The mean lifetime of the system is always ≤ 70 fm/c

were completed. Experimental stand for study of the magnetic system parameters using optical method of the electron beam parameter measurement was prepared. Construction of the positron trap used as a positron injector for the LEPTA ring was started. Construction of solenoid and vacuum chamber of the trap, vacuum chamber of the positron source based on ^{22}Na isotope is in the final stage. The programme of experimental study of the positronium parameters is developed. The positronium beam is generated by the electron cooling application to circulating positron beam. The first planned experiments are the following: direct comparison of the electron and positron electric charges, ortho- and para-positronium lifetime measurements, positronium spectroscopy.

Under works on beam channel for the electronuclear investigations a new variant of the proton beam channel, which guides the beam vertically to the subcritical assembly **SAD**, is developed. It is shown by the detail calculations that the existing coils (from the dismantled ARES installation) can be used to construct the bending magnet with the 120° bending angle to direct the proton beam to the SAD target from the bottom.

In 2002 under the JINR topic «**Further Development of Methods and Instrumentation for Radiotherapy and Associated Diagnostics with the JINR**

Hadron Beams», the following main results were obtained. About 20 patients (24 irradiated targets) were fractionally treated with the 150-MeV medical proton beam. The total number of the proton irradiations was 396. With ^{60}Co gamma unit «Rokus-M» 62 patients were also irradiated. A new therapeutic 170-MeV proton beam with the sharp distal fall-off Bragg peak was delivered to room No. 1 (Fig. 13). The use of this beam in treatment sessions will increase the conformity of dose distribution and target volume, which is most important in case of radiotherapy and radiosurgery of intracranial targets. For the same reason all necessary equipment for manufacturing patient specific fine collimators from cerrobend was designed and constructed. This technology has already been tested and now is used in treatment sessions. To increase the quality assurance (QA) standards of proton radiotherapy, the activity to design and construct a system for «on-line» measurements of main characteristics of the proton beam (symmetry, homogeneity and rang) during irradiation of patients has been started [26].

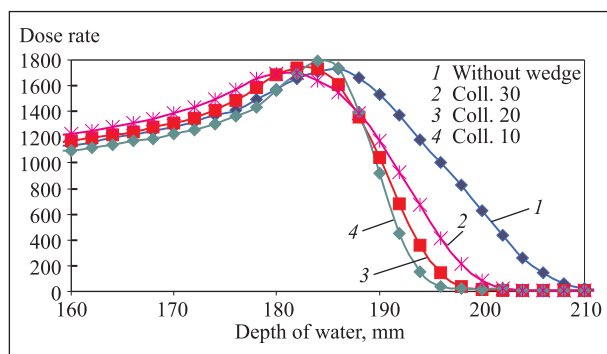

Fig. 13. Depth-dose distribution of the proton beams in the region of Bragg peak. Line 1 — present beam, line 3 — new delivered beam

REFERENCES

1. Bakalyarov A. *et al.* Search for β^- and $\beta^-\beta^-$ decays of ^{48}Ca // Nucl. Phys. A. 2002. V. 799. P. 17–24;
Bakalyarov A. *et al.* Improved limits on β^- and $\beta^-\beta^-$ decays of Ca-48 // Pis'ma v ZhETF. 2002. V. 76, No. 9. P. 643–644.
2. Yakushev E. A. *et al.* // J. Phys. G.: Nucl. Part. Phys. 2002. V. 28. P. 463;
Gromov K. Ya. *et al.* // Izv. RAN, ser. fiz. 2002. V. 66, No. 10.
3. Klapdor-Kleingrothaus H. V., Dietz A., Krivosheina I. V. // Foundations of Phys. 2002. V. 32. P. 1181.

4. Shitov Yu. *et al.* // Nucl. Phys. A. 2002. V. 699. P. 917–935.
5. Bystritskii Vit. M. *et al.* // ZhTF. 2002. V. 72, No. 9. P. 29–37.
6. Komarov V. *et al.* // Phys. Lett. B. 2002 (submitted); nucl-ex/0210017.
7. Bogdanova L. N. *et al.* JINR Preprint E15-2001-264. Dubna, 2001; Yad. Fiz. (submitted).
8. Mamedov T. N. *et al.* Investigation of interactions of aluminum acceptor impurity in the lattice of silicon by the μSR -method // Pis'ma v ZhETF. 2002. V. 76, No. 7, P. 440–443;
Mamedov T. N. *et al.* Interactions of μAl acceptor impurity in weakly and heavily doped silicon // Part. & Nucl. 2002. V. 33, No. 4. P. 1005.
9. Kalinnikov V. A. *et al.* 32-channel all-in-one CAMAC module as a basic element of anode wires read-out system for proportional chambers // Prib. Tekh. Eksp. (submitted).
10. Andreev E. M. *et al.* // Nucl. Instr. Meth. A. 2002. V. 489. P. 99.
11. Vorobyev L. S. *et al.* // Phys. At. Nucl. 1998. V. 61, No. 5. P. 771–780.
12. Balestra F. *et al.* // Nucl. Phys. A. 1980. V. 340. P. 372.
13. Akimov Yu. K. *et al.* Threshold aerogel counter // Prib. Tekh. Eksp. 2002;
Akimov Yu. K. Areas of application for aerogels (review) // Prib. Tekh. Eksp. (submitted).
14. DELPHI collab. Study of tau-pair production in untagged photon-photon collisions at LEP and limits on the anomalous magnetic and electric dipole moments of the tau lepton // Eur. Phys. J. C (submitted); 31st Intern. Conf. on High Energy Physics, Amsterdam, July 24–31, 2002.
15. Astier P. *et al.* (NOMAD collab.). A study of strange particle production in $\nu\mu$ charged current interactions in the NOMAD experiment // Nucl. Phys. B. 2002. V. 621. P. 3;
Naumov D. V. (NOMAD collab.). Measurement of Λ and Λ^- polarization in $\nu_\mu\text{CC}$ in NOMAD. hep-ph/0206032;
Ellis J. R., Kotzinian A., Naumov D. V. Intrinsic polarized strangeness and Λ^0 polarization in deep inelastic production. CERN-TH-2002-080. Apr. 2002; hep-ph/0204206; Eur. Phys. J. C (in press).
16. Bardi A. *et al.* The CDF online Silicon Vertex Tracker // Nucl. Instr. Meth. A. 2002. V. 485. P. 178;
Pukhov O. *et al.* Automatization of the monitoring and control of the muon scintillation counters at CDF-II // Part. Nucl., Lett. 2002. No. 5[114]. P. 72–81;
Artikov A. *et al.* MINISKIRT counter array at CDF II // Ibid. P. 25–39.
17. Alexandrov V. V. *et al.* // Proc. of ICRC-2001, Hamburg, Germany. 2002. P. 831;

- Khrenov B.A. (KOSMOTEPETL collab.). Space Particle Conf., La Siocola, Isola d'Elba, Italy, 2002; Garipov G.K. et al. // Izv. vusov (in press).*
18. *Bednyakov V.A. Why an Investigation of Ultra-high Energy Cosmic Rays Should Be Performed at an Orbit around the Earth // Part. & Nucl. 2002. V. 33. P. 1146.*
 19. *Afanasyev L.G. et al. First level trigger of the DIRAC experiment // Nucl. Instr. Meth. A. 2002. V. 479. P. 407;*
Afanasyev L.G. et al. The multilevel trigger system of the DIRAC experiment // Nucl. Instr. Meth. A. 2002. V. 491. P. 376;
Afanasyev L., Karpukhin V. Drift chamber readout system of the DIRAC experiment // Nucl. Instr. Meth. A. 2002. V. 492. P. 351.
 20. *Bauer F. et al. The First Precision Drift Tube Chambers for the ATLAS Muon Spectrometer // Nucl. Instr. Meth. A. 2002. V. 478. P. 153;*
Bauer F. et al. Large-Scale Production of the Precision Drift Tube Chambers for the ATLAS Muon Spectrometer. MPI-PhE/2002-01. April 30, 2002.
 21. *Batusov V. et al. Comparison of ATLAS Tile Cal MODULE 8 high precision metrology results by JINR — Laser and CERN — Photogrammetric methods // Part. Nucl., Lett. 2002. No. 4 [113].*
 22. *Akhmadaliev S. et al. Hadron Energy Reconstruction for the ATLAS Calorimetry in the Framework of the Non-parametrical Method // Nucl. Instr. Meth. A. 2002. V. 480. P. 506.*
 23. *Avdeyev S.P. et al. // Nucl. Phys. A. 2002. V. 709. P. 392.*
 24. *Rodionov V.K. et al. // Nucl. Phys. A. 2002. V. 700. P. 457.*
 25. *Karnaikhov V.A. et al. Thermal multifragmentation of hot nuclei and liquid-fog phase transition. JINR Preprint E6-2002-75. Dubna, 2002; Phys. At. Nucl. (in press).*
 26. *Mytsin G.V. et al. Hadron Therapy Centre in Dubna, Status and Prospects // Proc. of the 3rd Russian Sci. Conf. «Radiology and Radiotherapy in Clinic of XXI Century». M., 2002. P. 109;*
Luchin Y.I. et al. Proton Conformal Radiotherapy of Intracranial Tumors: New Clinical Program at the JINR Hadron Therapy Complex // Ibid. P. 98;
Luchin Y.I. et al. Proton Three-Dimensional Radiotherapy and Radiosurgery of Intracranial Targets: New Clinical Program at the Dubna Proton Therapy Facility // Radiotherapy and Oncology. 2002. V. 64 (Suppl. 1). P. S296.

FLEROV LABORATORY OF NUCLEAR REACTIONS

In 2002, the FLNR scientific programme on heavy ion physics included experiments on the synthesis of heavy and exotic nuclei using ion beams of stable and radioactive isotopes and studies of nuclear reactions, accelerator technology and applied research.

Reliable performance of the FLNR accelerators is a prerequisite for successful experiments and technical development. In 2002, the operation time of the U400 and U400M FLNR cyclotrons was nearly 8000 hours, which is in accordance with the plan.

HEAVY ION PHYSICS

Synthesis of New Elements

In the experiments on the synthesis of super-heavy elements performed during 1998–2001, decays of the heaviest nuclei ^{277}Hs ($Z = 108$), $^{280,281}\text{110}$, $^{283,284,285}\text{112}$, $^{287,288,289}\text{114}$ and $^{292}\text{116}$ were observed in the ^{48}Ca -induced reactions [1].

Among the accessible superheavy nuclides, even-even isotopes are of utmost interest as their properties can be calculated theoretically most precisely. Four even-even nuclides involved in the decay chains $^{292}\text{116} \rightarrow (^{288}\text{114}) \rightarrow ^{284}\text{112} \rightarrow ^{280}\text{110}$ were recently produced in the reactions $^{48}\text{Ca} + ^{244}\text{Pu}$, ^{248}Cm . The very fact of the α -decay predominance in the new nuclei with $Z = 112$ – 116 and $N = 172$ – 176 demonstrates their high stability against spontaneous fission (SF). Their decay energies and lifetimes point to a considerable increase in the stability of nuclei with $Z \geq 110$ as the neutron number increases. In general, these findings support theoretical predictions concerning the influence of closed nuclear shells in a large domain of nuclides close to $Z = 114$ or higher and $N = 184$.

The main attention in 2002 was paid to the experiments aimed at the synthesis of element $Z = 118$ in the reaction $^{249}\text{Cf} + ^{48}\text{Ca}$ [2]. Using experimental cross sections of the reactions $^{204-208}\text{Pb}(^{48}\text{Ca}, xn)^{(252-256)-x}\text{No}$ measured in a wide energy range, together with the experimental cross

sections of the reactions $^{244}\text{Pu}(^{48}\text{Ca}, 4n)^{288}\text{114}$ and $^{248}\text{Cm}(^{48}\text{Ca}, 4n)^{292}\text{116}$, production cross sections of

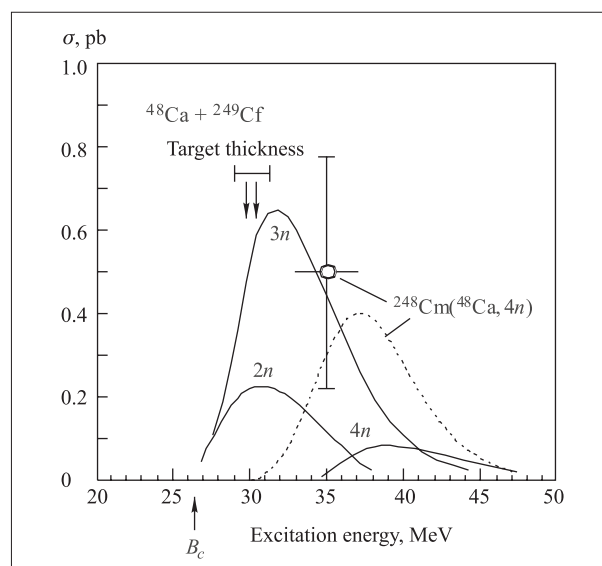

Fig. 1. Calculated excitation functions for the $2n$ -, $3n$ - and $4n$ -evaporation channels in the reaction $^{249}\text{Cf} + ^{48}\text{Ca}$. The arrows show excitation energies corresponding to the events observed in the experiment and to the Bass barrier B_c . The dashed line and the experimental point refer to the reaction $^{248}\text{Cm}(^{48}\text{Ca}, 4n)^{292}\text{116}$

isotopes of element 118 in the neighbouring reaction $^{249}\text{Cf} + ^{48}\text{Ca}$ were estimated (Fig. 1).

The experiment was performed during February–June, 2002. In a 2300-hour irradiation a total beam dose of $2.5 \cdot 10^{19}$ of ^{48}Ca ions was accumulated. The beam energy generated by the FLNR cyclotron U400 was determined and controlled by a time-of-flight mea-

suring system and by a Si(Au) surface-barrier detector which registered ions scattered from a thin Au target.

The complete-fusion reaction products emerging from the target were separated in flight from the primary beam, scattered target and beam particles, and various transfer-reaction products by the Dubna Gas-filled Recoil Separator, shown schematically in Fig. 2.

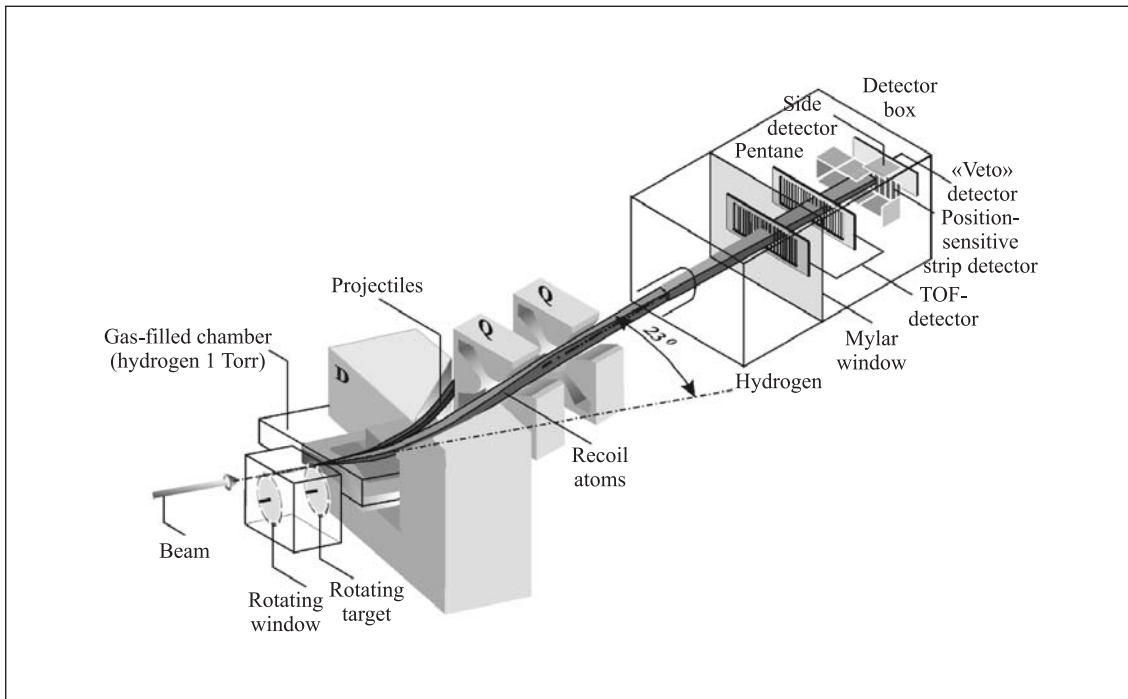

Fig. 2. A schematic view of the Dubna Gas-filled Recoil Separator: D is the dipole magnet; Q is the quadrupole doublet

The separator magnetic rigidity was set to transport the $Z = 118$ EVRs according to the estimated average charge ($\bar{q} \approx 5.7$) of the $Z = 118$ recoils in the hydrogen gas filling the separator. The time of flight of a recoiling nucleus traversing the separator from the target to the focal-plane detector (a distance of 4 m) was about 1 μs .

The enriched ^{249}Cf (97.3 %) for preparing the target was produced at the reactor facility of RIAR (Dimitrovgrad). The target material was deposited onto the 1.5- μm Ti foils in the form of CfO_2 (0.23 mg/cm^2). The target, rotating at 2000 rpm in the hydrogen atmosphere (1 Torr) of the gas-filled separator, had 6 separate target sectors, each being 5.3 cm^2 in area.

From the previous experiments and calculations, the separator collection efficiency for recoils with $Z = 118$ emerging from the ^{249}Cf target was estimated at about 35 %. The energy resolution for the full energy α particles registered by the focal-plane detector was about 0.06 MeV. The fission-fragment energy calibration was performed using SF fragments from the decay of ^{252}No produced in the reaction $^{206}\text{Pb}(^{48}\text{Ca}, 2n)$. In cali-

bration experiments the vertical position resolution for the detection of correlated decays was estimated at (1.1 ± 0.2) mm (FWHM).

In the present experiment a total of 18 SF events were detected. They can be separated into two groups by the energy value (Fig. 3). The 16 SF events with $\bar{E}_{\text{tot}} = 160$ MeV can be assigned with a high probability to the long-lived nuclides around Cf–Fm which are produced in incomplete fusion reactions and whose yield is suppressed by more than 5 orders of magnitude by means of the gas-filled separator.

The two fission events with $E_{\text{tot}} = 207$ and 223 MeV were observed in the form of a chain of correlated decays R- α_1 - α_2 -SF and a correlated decay R-SF, respectively (Fig. 4). Both events correspond to the excitation energy $E^* = (30.0 \pm 2.5)$ MeV of the compound nucleus $^{297}118$ near the maximum of the $3n$ -evaporation reaction channel with a cross section of about 0.5 pb.

In the first event sequence (Fig. 4, a), the parent nucleus undergoes two α decays and a subsequent spontaneous fission decay. For the allowed α transitions in

the even-even nuclides, the decay energy Q_α and half-life $T_{1/2\alpha}$ are correlated and depend only on Z of the decaying nucleus (Geiger–Nuttall rule). Employing this rule in the form of the Viola–Seaborg formula, one can calculate the atomic number Z of the nuclides which undergo α decay prior to SF. As far as both observed α decays are genetically linked, such α transitions correspond to the $^{294}_{118} \rightarrow ^{290}_{116} \rightarrow ^{286}_{114}$ decay chain.

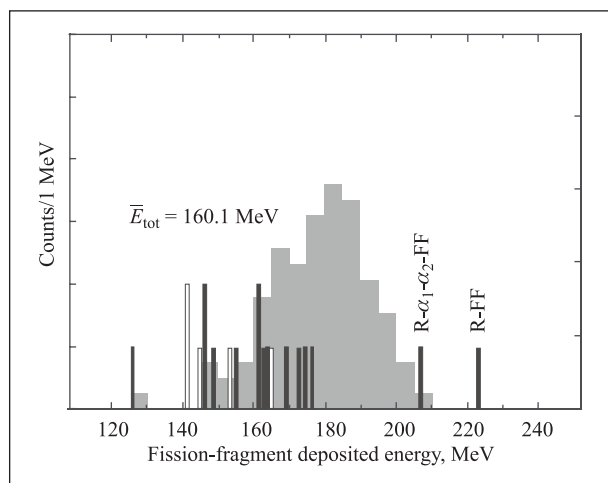

Fig. 3. Energies of the fission fragments detected in the present experiment. The bar diagram shows the E_{tot} distribution for ^{252}No measured in the $^{206}\text{Pb} + ^{48}\text{Ca}$ calibration experiments

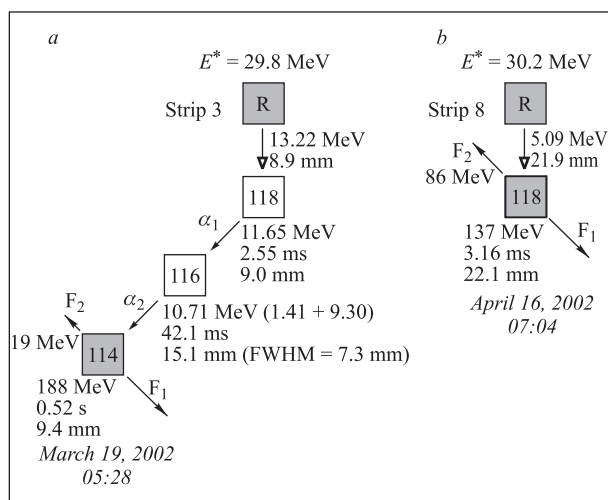

Fig. 4. Decay chains of nuclei ending in SF with $E_{\text{tot}} = 207$ (a) and 223 MeV (b). Excitation energies (E^*) of $^{297}_{118}$ are shown, corresponding to the instantaneous beam energy associated with the detection of the decay events

Figure 5 shows the values of $\overline{\text{TKE}}$ versus the parameter $Z^2/A^{1/3}$ for all the known spontaneously fissioning nuclei with $Z \geq 96$. This includes the data of the present experiment on $^{286}_{114}$ taken from the first decay chain and on $^{294}_{118}$ from the second one (Fig. 4, b). One can see that the increase in $\overline{\text{TKE}}$ released in SF agrees well with the trend observed in the

asymmetric fission of the heaviest nuclides. One can suppose that the observed SF with $E_{\text{tot}} = 223$ MeV ($\text{TKE} \sim 245$ MeV) is related to the SF decay branch of $^{294}_{118}$ itself.

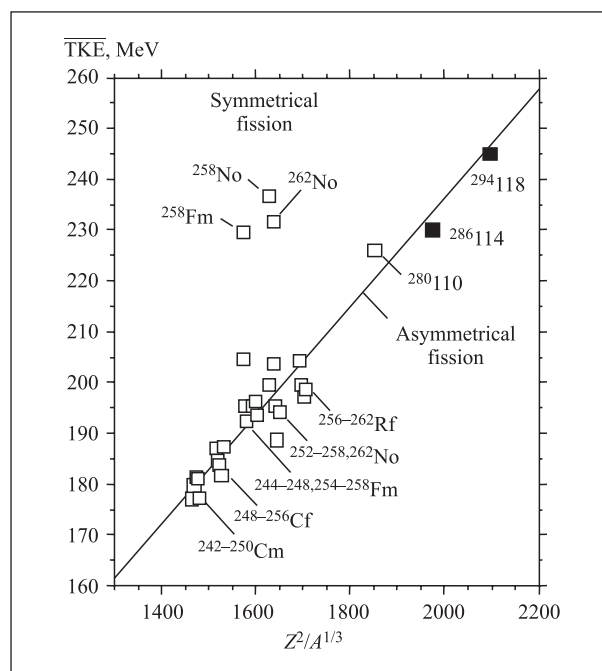

Fig. 5. Systematics of $\overline{\text{TKE}}$ for even-even nuclei with $Z \geq 96$. The open squares — experimental values of $\overline{\text{TKE}}$ versus the parameter $Z^2/A^{1/3}$; the solid squares — experimental data from [2]

The very fact of observing SF in the transition from the nuclide with $Z = 116$ ($N = 176$) to a heavier one with $Z = 118$ ($N = 176$) may point to being close to the border of stability of superheavy nuclei at the high- Z side. Additional information is needed for drawing more definite conclusions concerning the limits of stability of superheavy nuclei against spontaneous fission. Experiments on the synthesis of element $Z = 118$ will be continued in 2003.

Chemistry of Transactinides

Relatively long half-lives of the isotopes with $Z = 108 \div 114$, produced in the ^{48}Ca -induced reactions, open up new opportunities for the investigation of chemical properties of superheavy elements. According to theoretical predictions, transactinides with $Z = 112-120$ in their chemical properties are expected to be homologues of Hg–Ra.

The second experiment on chemical identification of element 112 was performed in 2002 [3]. Element 112 (E112) must belong to the IIB group Zn–Cd–Hg–E112. Similarly to the first test in 2000, a 2-mg/cm² ^{238}U (+50 μg NdO_2) target was bombarded with the 262-MeV ^{48}Ca ions to produce in the reaction $^{238}\text{U}(^{48}\text{Ca}, 3n)$ the 3-min isotope $^{283}_{112}$ decaying

by spontaneous fission. The reaction products recoiling from the target were thermalized in flowing helium and transported by the gas to the detectors 25 m apart. Of all heavy elements, only Hg, Rn and At could be efficiently transported and thus selectively isolated.

Two different devices were employed for detecting fission fragments and alpha particles (Fig. 6): an as-

sembly of sixteen PIPS detectors coated with Au to detect «Hg-like» nuclides which adsorbed on Au at ambient temperature and a flow-through ionization chamber, 5000 cm³ in volume, which served to detect activities still staying in the gas after passing the PIPS detector chamber. Both devices were placed into an assembly of 126 ³He neutron counters to detect prompt fission neutrons.

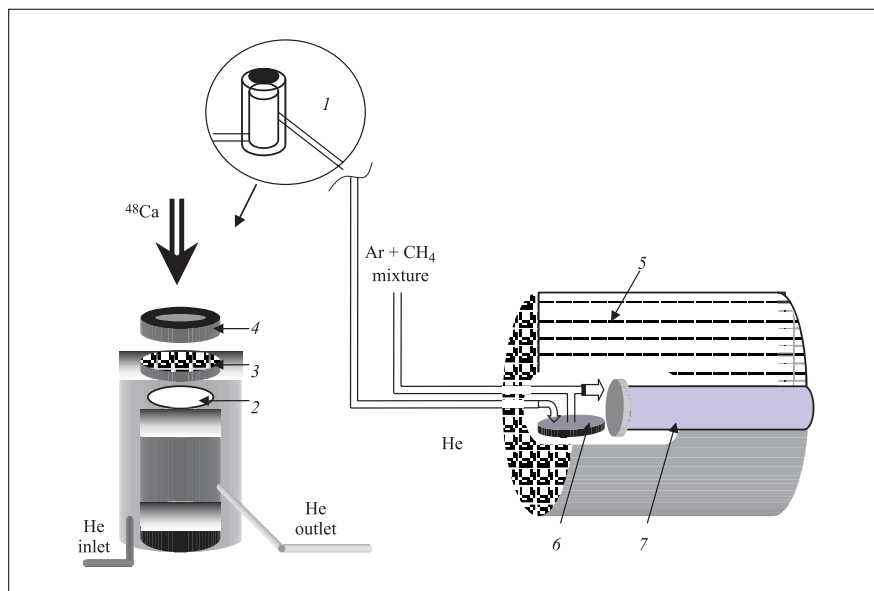

Fig. 6. Schematic view of the set-up for isolation and identification of element 112: 1 — recoil chamber; 2 — ²³⁸U target; 3 — grating; 4 — collimator; 5 — assembly of 126 ³He neutron counters; 6 — chamber with 8 pairs of PIPS detectors; 7 — ionization chamber

Within 22.5 days of bombardment a beam dose of $2.8 \cdot 10^{18}$ ions was collected. Whereas the 49-s α -active ¹⁸⁵Hg simultaneously produced on Nd completely deposited on the first PIPS detector, no SF events were observed in that detector chamber. In the ionization chamber, eight spontaneous fission events in coincidence with neutrons were observed. These decays can be attributed to the spontaneous fission of element 112, and the evaluated production cross section for this nucleus was about 2 pb.

The values of the adsorption energy enthalpy calculated from the experimental data confirm the fact that interaction of element 112 with the Au surface is weaker than that of Hg by about 60 kJ/mol and stronger than that of Rn by no more than 20 kJ/mol. These facts point to «noble-gas-like» rather than «Hg-like» behaviour of element 112 in the given chemical environment.

In preparation for a further study of chemistry of element 114, the transportation of the carrier-free radionuclides ^{195,197}Hg, ²²⁰Rn and ²¹²Pb along a quartz thermochromatographic column was studied. In the field of aqueous solution chemistry of superheavy elements, adsorption of the radionuclides on chemically

active surfaces was investigated by means of combining the fast separation technique with the source preparation for alpha spectroscopy.

Separator MASHA

The formation cross sections for heaviest nuclei in the fusion reactions amount to a few or to fractions of a picobarn. The charge and mass numbers of the new nuclides are identified on the basis of their decay properties and the data from additional experiments (cross reactions, probability of different decay channels, etc.), which, in the case of small cross sections, is quite a difficult problem.

According to calculations of the atomic structures, the elements EkaHg–EkaRa ($Z = 112–120$) should be more volatile than their stable analogues Hg–Ra. Thus the experimental approach to the investigation of superheavy atoms in heavy-ion-induced reactions can be radically changed — instead of separating reaction products by their kinematic characteristics, using in-flight recoil separators, they may be separated by their mass using on-line mass separators.

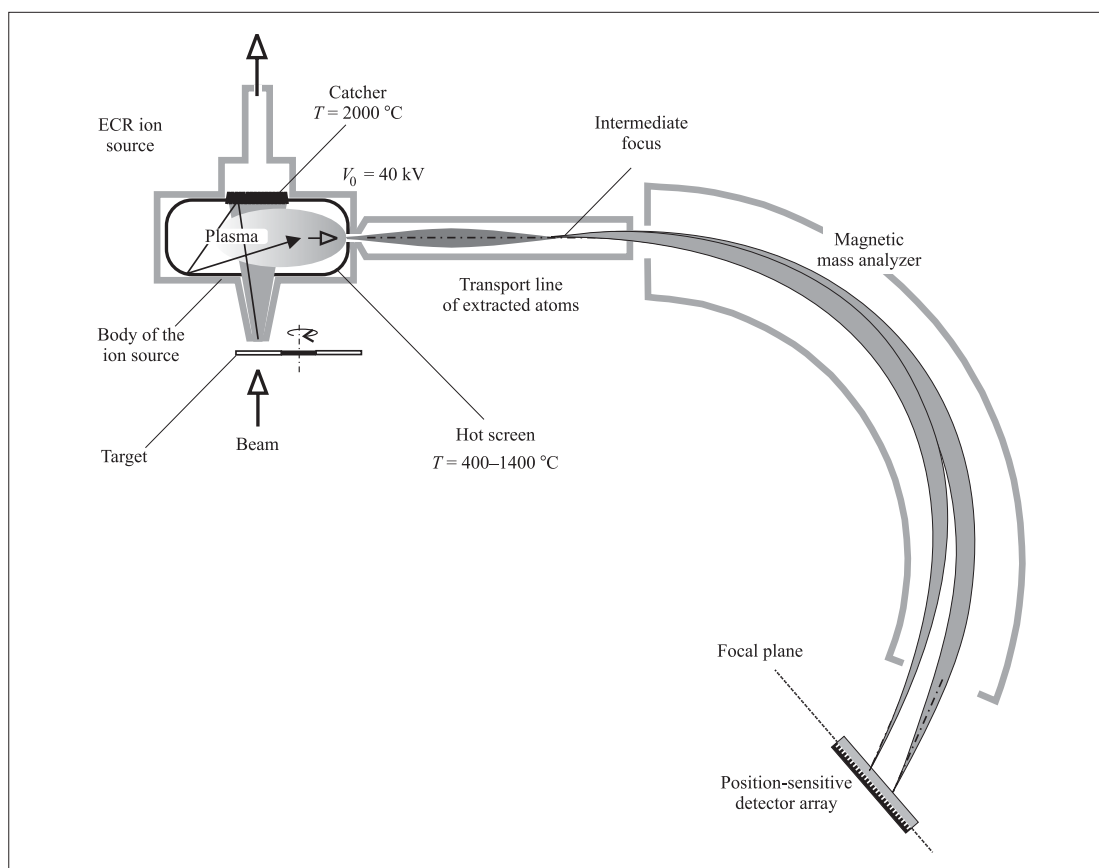

Fig. 7. Schematic view of the magnetic analyzer of superheavy atoms (MASHA)

The principle of operation of a fast mass separator, directly determining the mass of the separated atoms, is well known (Fig. 7). The reaction products are stopped in a heated catcher (it can be the target itself), diffuse from the catcher into the ion source, after ionization they are extracted by electric field and analyzed by their mass in a magnetic high-resolution spectrometer.

In 2002, the design of the Mass Analyzer of Super Heavy Atoms (MASHA) [4] was finished. The above-mentioned principle was used, which can provide

a mass resolution of about 1000. Planned characteristics of the mass analyzer are compared with those of existing recoil separators in Table 1.

The MASHA set-up will surpass all known facilities both in efficiency of obtaining superheavy atoms and in extracting information on their masses and decay characteristics. It also opens up new possibilities for the study of chemical properties of superheavy elements. First experiments with the use of this separator are scheduled for 2003.

Table 1

| Parameters | Recoil separator | MASHA (projected) |
|---|----------------------------------|-------------------|
| Target thickness, mg/cm ² | 0.3 | 1.5 or more |
| Angular acceptance, ° | ±2.5 | ±10 or more |
| Energy range, MeV | 3 | 15 or more |
| Ion charge of recoiling atoms | 20 ± 2 | 1 |
| Transmission efficiency, % | 30 | ≥ 20 |
| Suppression of target-like recoil atoms | 10 ³ –10 ⁵ | > 10 ⁸ |
| Precision of mass measurements | ±25 | ±0.25 |
| Mass range, a. m. u. | 1 | 18 |
| Number of synthesized isotopes | 1 | 2 or more |
| Relative yield at given luminosity | 1 | 4–5 |

Nuclear Fission

In 2002, a series of experiments aimed at the study of processes of fusion–fission and quasi-fission of heavy and superheavy nuclei with $Z = 102$ – 122 was carried out at energies near and below the Coulomb barrier using the CORSET + DEMON + HENDES set-up.

The set-up consists of a two-arm time-of-flight spectrometer of fission fragments CORSET, neutron multi-detector DEMON, neutron tubes HENDES and NaI(Tl) spectrometer of γ quanta, and allows measurements of mass-energy distributions of fission fragments, pre-equilibrium, pre- and post-scission neutrons, mean multiplicities and γ -quantum energies.

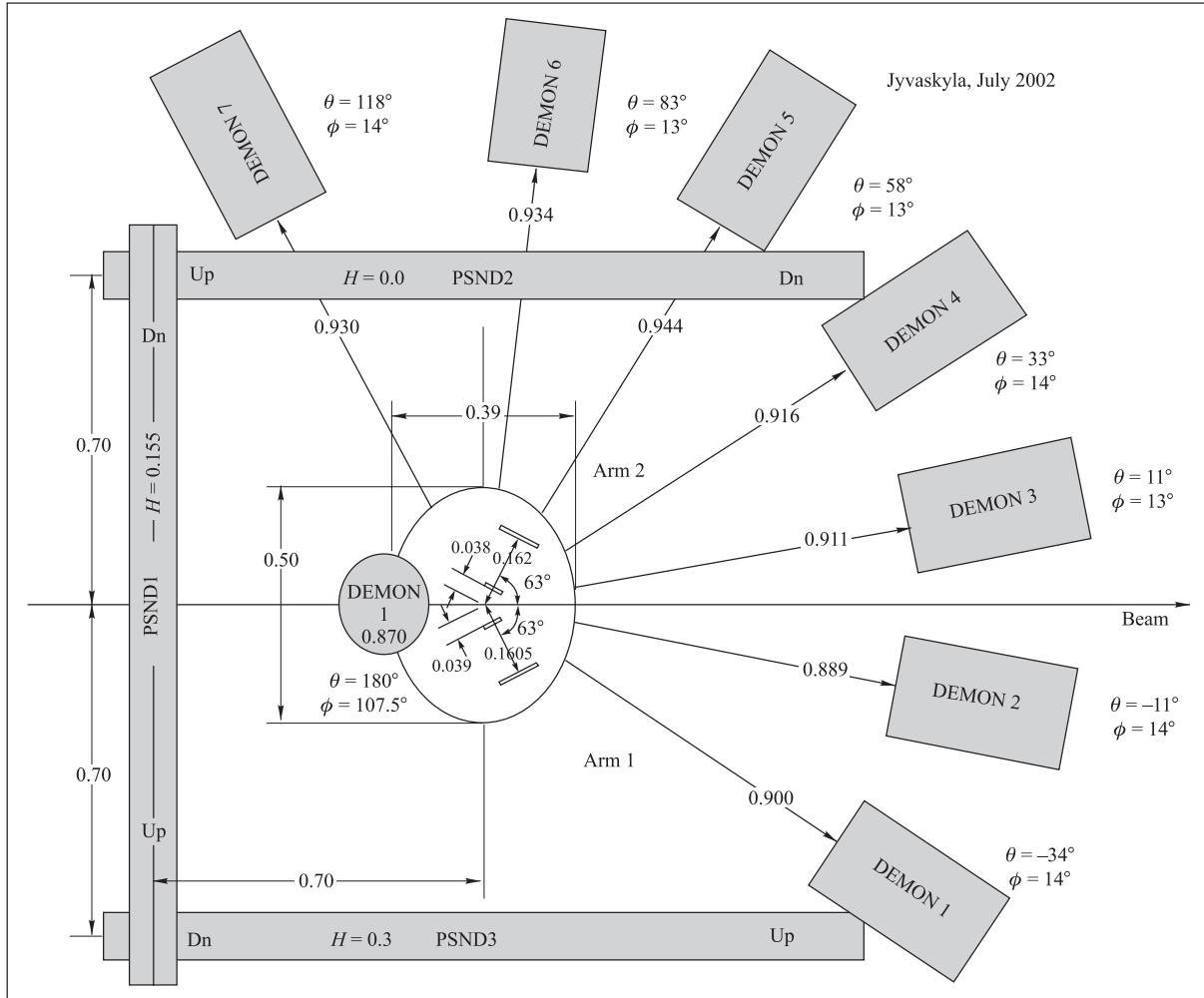

Fig. 8. Scheme of the CORSET + DEMON + HENDES set-up

The time resolution of the spectrometer of fission fragments composed of micro-channel plates was 120–150 ps, which corresponds to 2 a. m. u. in mass resolution. Doubly differential spectra of neutrons were measured using the DEMON detectors and position-

sensitive neutron tubes which allow measurements of neutrons with energies of up to 50 MeV. The experiments carried out in 2002 and the studied reactions are listed in Table 2.

Table 2

| Set-ups | Reactions (energies) |
|-------------------------|--|
| CORSET + PIG | $^{48}\text{Ca} + ^{168,170}\text{Er} \rightarrow ^{216,218}\text{Ra}$ (180–204 MeV) |
| CORSET + PIG | $^{48}\text{Ca} + ^{168}\text{Er} \rightarrow ^{216}\text{Ra}$ (194, 208 MeV), $^{48}\text{Ca} + ^{154}\text{Sm} \rightarrow ^{202}\text{Pb}$ (165–208 MeV) |
| CORSET + HENDES + DEMON | $^{64}\text{Ni} + ^{242}\text{Pu} \rightarrow ^{306}122$ (355, 380, 420 MeV), $^{64}\text{Ni} + ^{186}\text{W} \rightarrow ^{250}\text{No}$ (300, 355 MeV) |

As a result of these experiments, for the first time the fission properties of compound nuclei $^{216,218}\text{Ra}$, ^{250}No and $^{306}\text{122}$ formed in the reactions with ^{48}Ca and ^{64}Ni ions were investigated. Proceeding from these data, some new and important physical results were obtained:

- the mass distribution of fission fragments of the $^{306}\text{122}$ compound nucleus is asymmetric, and, in contrast to the asymmetric fission of actinides, the nature of this asymmetry is determined by the shell structure of the light fission fragment with the average mass 132–134;

- the total kinetic energy of fission fragments in the fission process differs significantly from that in the quasi-fission process — it is much higher in fusion-fission reactions than in the quasi-fission process;

- the total neutron multiplicity M_{tot} grows monotonously with increasing atomic number of the compound nucleus in the case of fission fragments with $A/2 \pm 20$. At the same time in the region of fission fragment masses, in which the quasi-fission process dominates, the absolute M_{tot} values are smaller, and the dependence on Z of the compound nucleus is rather weak.

Mass-energy distributions of ^{216}Ra fission fragments were investigated using two ion-target combinations $^{12}\text{C} + ^{204}\text{Pb}$ and $^{48}\text{Ca} + ^{168}\text{Er}$ [5]. It was found that at the excitation energy $E^* \sim 40$ MeV the contribution of the asymmetric component was 1.5 % in the case of the first reaction, and it was about 30 % in the case of the second one. Such a sharp increase in the yield of the asymmetric component in the reaction $^{48}\text{Ca} + ^{168}\text{Er}$ can be connected with the dominance of the quasi-fission process, the mass distribution of which shows a pronounced shell structure.

It was also found that the cross sections of the fusion-fission reactions between ^{48}Ca and ^{58}Fe changed very slowly with an increase in the charge and mass of the target nuclei, which is of great importance for planning the new experiments on the synthesis of superheavy nuclei with $Z > 110$ [6].

Separator VASSILISSA

As a first step in improving the identification of complete fusion reaction products, a new dipole magnet, having a deflection angle of 37° , was installed behind the separator VASSILISSA, replacing the old 8° magnet. In order to reach sufficient position separation of nuclides with different masses, a new detector system, having a focal-plane 32-strip detector 60×120 mm in size, was also developed.

Test experiments with ^{40}Ar and ^{48}Ca beams and Dy, Yb and Pb targets showed that the new magnet provided an additional suppression for unwanted products by a factor of about 10 and a possibility to have the mass resolution for heavy nuclei with masses of about 300 a. m. u. at the level of 2 %.

In experiments on the synthesis of element 115 in the reaction $^{48}\text{Ca} + ^{243}\text{Am}$, the reaction product masses will be determined directly using the modernized separator VASSILISSA.

The new neutron-deficient isotope ^{249}No was produced and identified, the decay properties of ^{250}No isotope were defined more precisely in the fusion reactions $^{48}\text{Ca} + ^{204}\text{Pb}$ and $^{44}\text{Ca} + ^{208}\text{Pb}$ leading to the same compound nucleus $^{252}\text{No}^*$ [7].

High-Resolution Beam Line ACCULINNA

Hydrogen isotopes heavier than tritium have been of interest over the past forty years. All experimental data on ^4H reported to this day suggest broad resonance states in this nucleus. Only a few experiments aimed at the search for the unbound ^5H were carried out.

Radioactive nuclear beams provide favourable conditions for the study of this nucleus. The advantageous energy balance of these reactions leads to higher cross sections. Their mechanism turns out to be simpler, resulting in a lower physical background than it is with stable beams.

In 2002, new results were obtained in the study of ^4H and ^5H nuclei, which were produced in the reactions $^2\text{H}(t, p)^4\text{H}$ and $^3\text{H}(t, p)^5\text{H}$ with the use of the 57.5-MeV triton beam. The work on ^5H was complemented by the study of the reaction $^2\text{H}(^6\text{He}, ^5\text{H})^3\text{He}$.

A triton beam with a typical intensity of $3 \cdot 10^7 \text{ s}^{-1}$ delivered by the U400M cyclotron was transported by the modified beam line of the ACCULINNA separator to a shielded room in which a reaction chamber housing the tritium (deuterium) target and particle detectors were installed (Fig. 9). The beam energy and the energy spread obtained in the median plane of the target were 57.5 MeV and 330 keV, respectively.

The ACCULINNA separator was used to cut off and clean the secondary ^6He beam produced in the fragmentation reactions between the 32 A·MeV ^{11}B beam and a thick beryllium target. An average energy of the ^6He beam ions delivered to the median plane of a deuterium gas target was 133 MeV and a typical intensity was about $2 \cdot 10^5 \text{ s}^{-1}$.

Experiments aimed at the search for the ^7H nucleus included direct detection of the long-lived ^7H nuclei which could be produced in the $^2\text{H}(^8\text{He}, ^7\text{H})^3\text{He}$ reaction. Using the 32 A·MeV primary beam of ^{11}B ions, a secondary beam of ^8He ions having an energy of 160 MeV and a typical intensity of $2 \cdot 10^4 \text{ s}^{-1}$ was produced. Some essential conditions inherent in the studied reactions are listed in Table 3 [8].

The missing mass energy spectrum was obtained for the ^4H nucleus as a result of the study of the reactions $^2\text{H}(t, p)^4\text{H}$ and $^3\text{H}(t, d)^4\text{H}$. The position and width of the ^4H resonance state, $E_R = 3.3$ MeV and $\gamma^2 = 2.3$ MeV, were deduced.

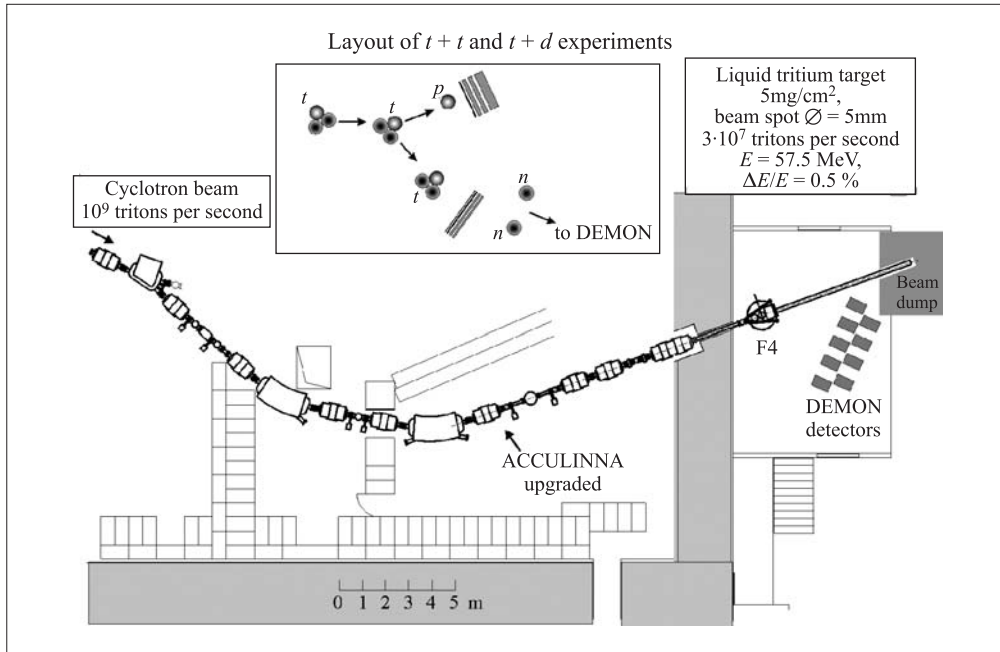

Fig. 9. Schematic view of the experimental installation for the investigation of ${}^4\text{H}$, ${}^5\text{H}$ and ${}^7\text{H}$ nuclei

Table 3

| Nucleus of interest | Reaction | Projectile energy, MeV | Method | Main detected products and their energy range, MeV |
|---------------------|--|------------------------|--------------|--|
| ${}^4\text{H}$ | ${}^2\text{H}(t, p){}^4\text{H}$ | 57.5 | Missing mass | Protons, (39–25) |
| ${}^4\text{H}$ | ${}^3\text{H}(t, d){}^4\text{H}$ | 57.5 | Missing mass | Deuterons, (42–25) |
| ${}^5\text{H}$ | ${}^3\text{H}(t, p){}^5\text{H}$ | 57.5 | Missing mass | Protons, (36–20) |
| ${}^5\text{H}$ | ${}^2\text{H}({}^6\text{He}, {}^5\text{H}){}^3\text{He}$ | 133 | Missing mass | ${}^3\text{He}$, (10.5–25) |
| ${}^7\text{H}$ | ${}^2\text{H}({}^8\text{He}, {}^7\text{H}){}^3\text{He}$ | 153–92 | Direct | ${}^7\text{H}$, (55–105) |

Data obtained in the study of the reactions ${}^3\text{H}(t, p){}^5\text{H}$ and ${}^2\text{H}({}^6\text{He}, {}^5\text{H}){}^3\text{He}$ indicate that the ${}^5\text{H}$ resonance state was observed at the energy $E_R = (1.8 \pm 0.1)$ MeV above the $t + n + n$ decay threshold. The missing mass spectrum of the ${}^5\text{H}$ nucleus obtained in the reaction ${}^3\text{H}(t, p){}^5\text{H}$ is most likely to display another narrow resonance state at $E_R = (2.7 \pm 0.1)$ MeV. The small resonance with $\Gamma_{\text{obs}} \leq 0.5$ MeV which was found in the case of both reactions is quite surprising. Evidently, it will be difficult to reconcile such a small resonance with the suggested theory concepts. This makes intriguing a further study of the ${}^5\text{H}$ nucleus.

A limit of $1 \cdot 10^{-32} \text{ cm}^{-2}$ was obtained for the cross section of the reaction ${}^2\text{H}({}^8\text{He}, {}^7\text{H}){}^3\text{He}$, which could result in the formation of ${}^7\text{H}$ nuclei with the lifetime $\tau \geq 3 \cdot 10^{-9}$ s.

Reactions Induced by Stable and Radioactive Ion Beams of Light Elements

The MSP-144 magnetic spectrometer was modernized for carrying out precision measurements of char-

acteristics of nuclear reaction products in reactions induced by ${}^6\text{He}$ beams. A high pulse resolution $\Delta p/p$, equal to 10^{-4} , was achieved. For measuring the fusion–fission cross sections the KAPRIZ multidetector spectrometer, composed of large-area strip detectors, was created.

In Dubna–GANIL collaborative experiments, two new isotopes, ${}^{34}\text{Ne}$ and ${}^{37}\text{Na}$, which lie beyond the predicted neutron-drip line, were produced. At the same time, no stable nuclei of the supposed magic ${}^{40}\text{Mg}$ isotope ($N = 28$) were detected in these experiments. This result indicates that on the nucleon-drip line the role of shell effects in nuclei changes and nuclear stability becomes dependent on the deformation.

The charge radii of argon isotopes between two closed neutron shells $N = 20$ and $N = 28$ were measured in collaboration with the groups COLLAPS (Mainz, Germany) and ISOLDE (CERN). The obtained results are an essential contribution to the charge radii systematics for the region of $Z = 20$ and $20 \leq N \leq 28$, in which it is expected that the nuclear structure undergoes inversion and shell numbers change.

Theoretical and Computational Physics

The main goal of the theoretical analysis of heavy ion fusion reaction leading to formation of a heavy evaporation residue was to gain better understanding of the whole process and to find out what factors and quantities, in particular, bring major uncertainty into the calculated cross sections, how reliable the calculation of the cross sections of super-heavy element formation may be and what additional theoretical and experimental studies should be made in this field.

The fusion–fission reactions $^{48}\text{Ca} + ^{208}\text{Pb}$, $^{48}\text{Ca} + ^{238}\text{U}$, $^{48}\text{Ca} + ^{244}\text{Pu}$ and $^{48}\text{Ca} + ^{248}\text{Cm}$ were analyzed on the basis of the fluctuation-dissipation dynamics. For the first time the lower limits for the fission barrier heights of $^{283-286}112$, $^{288-292}114$ and $^{292-296}116$ (5.5, 6.7 and 6.4 MeV) were derived [9]. The new data explain the relatively high stability of these nuclei.

For the fusion–fission process of a heavy nuclear system a new mechanism has been proposed, which takes place in the (A_1-A_2) space [10]. The nuclei A_1 and A_2 gradually lose (or acquire) their individualities with increasing (or decreasing) a number of collectivized nucleons ΔA . Figure 10 demonstrates rather good agreement between calculated and experimental

cross sections of the superheavy element formation in the «hot» and «cold» fusion reactions up to $Z_{\text{CN}} = 118$.

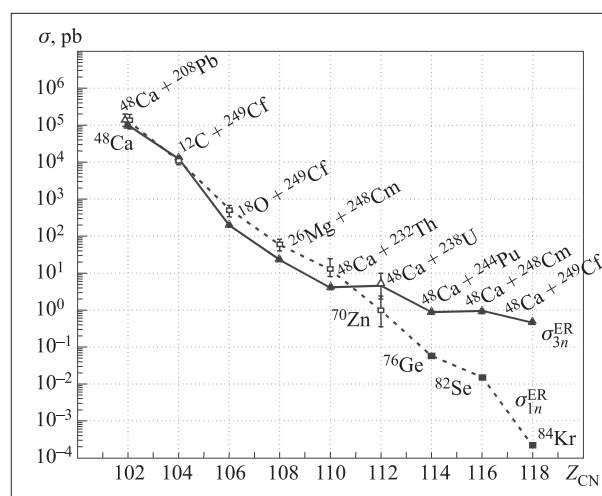

Fig. 10. Cross sections for formation of heavy evaporation residues in «hot» (triangles) and «cold» (squares) fusion reactions. The open symbols correspond to the experimental values, whereas the solid ones — to the calculated cross sections

APPLIED RESEARCH

Interaction of Heavy Ions with Polymers, Metals and Crystals

The influence of surface-active molecules on the etching of ion tracks in polymers was a subject of extensive investigation. In 2002, several different surface-active substances (surfactants) were studied in respect to their ability to affect the process of small pore evolution during etching. Polycarbonate and polyethylene terephthalate films were used as track-recording materials. The obtained pore profiles were investigated using a specially developed method of sample preparation for electron microscopy (Fig. 11). For understanding of the simultaneous action of etching agents and surface-active species, the diffusion of electrolytes and surfactants through ion track pores of various radii was studied.

A new type of heat transfer surfaces was studied in collaboration with the SDK company (Germany). This new application of ion track technique is based on the dependence of liquid evaporation on the specific area of a surface. The film of a liquid readily spreads over the textured surface due to capillary effect, thus the area of liquid/air contact is substantially enlarged. The evaporation is accompanied by fast heat transfer from the

metal substrate to the surrounding media. Using this principle, a new type of heat-transfer elements was developed. A series of experiments was performed with the aim of determining optimal geometrical characteristics of the textured surfaces. Copper tubes of 60–80 μm in height and 5–15 μm in diameter were fabricated and tested.

Investigation of ion-track nanopores in synthetic polymers are now in progress in collaboration with the Materials Research Group (GSI, Darmstadt) and the Institute of Cytology (St. Petersburg). Electrical properties of asymmetric nanopores created in polyethylene terephthalate (PET) and polyimide (PI) films were studied. It was shown that conically shaped nanopores in PET, immersed in an electrolyte, function as a voltage gate. The ion current through the pore shows voltage-dependent fluctuations, whose kinetics is similar to voltage-gated biological ion channels and pores.

The sputtering of metals and alloys exposed to heavy ions with high specific energy losses was investigated. Using the SEM method the sputtering yields were estimated: for Ni, ~ 500 atoms/ion; for chromium-nickel steel, ~ 100 atoms/ion; for W, ~ 1260 atoms/ion.

The surface structure of Al_2O_3 , silicon monocrystals and pyrolytic graphite after the irradiation with ^{86}Kr (305, 440 and 750 MeV), ^{136}Xe (605 MeV) and ^{209}Bi (705 MeV) ions was studied using atomic force microscopy (AFM) and scanning tunneling microscopy (STM). The results are important for selecting the materials for the first wall of thermonuclear reactors and for understanding the physics of interaction between high-energy ions and condensed matter.

scopy (STM). The results are important for selecting the materials for the first wall of thermonuclear reactors and for understanding the physics of interaction between high-energy ions and condensed matter.

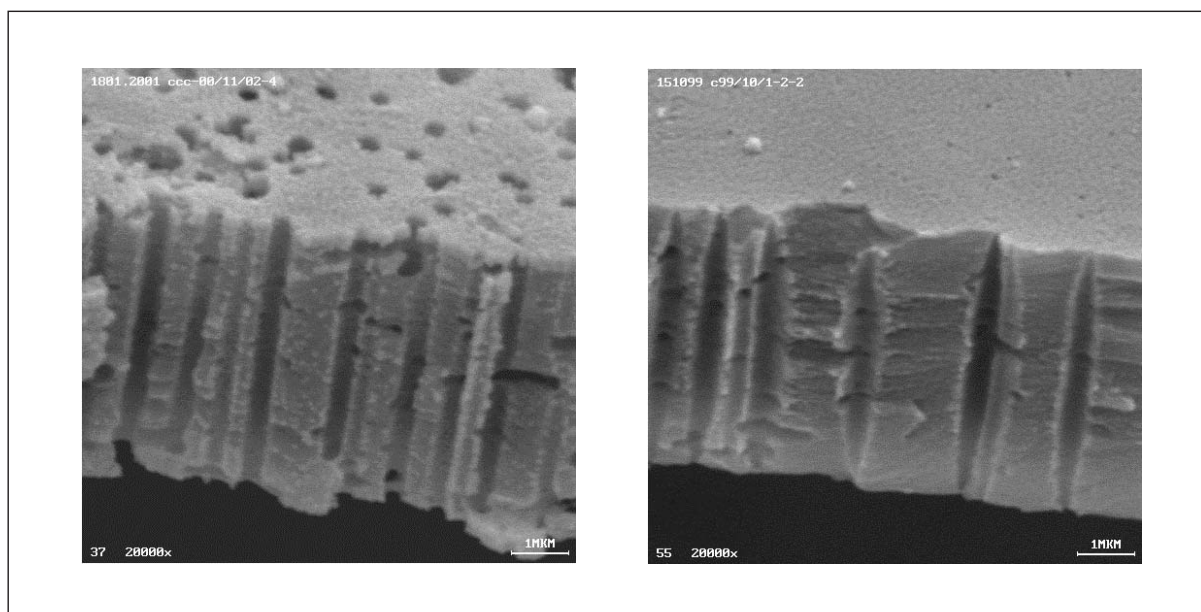

Fig. 11. Effect of a surface-active agent on the ion track pore shape. Left: cylindrical pores produced by etching of an ion-irradiated PET film using 5M NaOH; right: cigar-like pores produced using surfactant-enhanced etching

Ultrapure Radioisotopes and Radioanalytical Investigations

The U200 cyclotron and MT25 microtron were systematically used for the production of ultrapure radioisotopes $^{88,89}\text{Zr}$, ^{111}In , ^{149}Tb , ^{175}Hf , ^{211}At , $^{236,237}\text{Pu}$ and tracers ^{99}Mo , ^{129}Cs , ^{178}W , ^{131}Ba , ^{133m}Ba , ^{135m}Ba , ^{140}La , ^{183}Re , ^{203}Pb for radio-

biological and radioanalytical investigations. New methods using the (γ, f) and (n, f) reactions for determining natural and artificial actinides in environment samples and biological objects were elaborated. These methods were employed for determining the chemical composition and abundances of Th, U, Np, Pu and Am in soil and maritime depositions from Vietnam.

PHYSICS AND HEAVY ION ACCELERATOR TECHNIQUES

Development of the accelerator technique was focused on the realization of the DRIBs project (production of radioactive ion beams at Dubna cyclotrons). According to the schedule of stage I of the project, a complex for the generation, ionization and separation of ^6He and ^8He ions was created and tested at the ^7Li beam of the cyclotron U400M. A radioactive ^6He beam was transported from the U400M hall to a distance of 120 m and accelerated up to an energy of 15 MeV/A using the U400 cyclotron [11]. The extraction of the ^6He

beam from U400 and its delivery to physical targets is scheduled for June, 2003.

REFERENCES

1. Oganessian Yu. Ts., Utyonkov V. K., Moody K. J. // Phys. At. Nucl. 2001. V. 64. P. 1349.

2. *Oganessian Yu. Ts. et al.* JINR Preprint E7-2002-287. Dubna, 2002.
3. *Yakushev A. B. et al.* // Radiochem. Acta (submitted).
4. *Oganessian Yu. Ts.* JINR Preprint E7-2002-64. Dubna, 2002.
5. *Chizhov A. Yu., Itkis M. G. et al.* // Phys. Rev. C. 2003. V. 67. P. 011603(R).
6. *Itkis M. G. et al.* // J. Nucl. Radiochem. Sci. 2002. V. 3. P. 57.
7. *Belozarov A. V. et al.* // Eur. Phys. J. (in press).
8. *Golovkov M. S. et al.* // Phys. Lett. B (submitted).
9. *Itkis M. G., Oganessian Yu. Ts., Zagrebaev V. I.* // Phys. Rev. C. 2002. V. 65. P. 044602.
10. *Zagrebaev V. I.* // J. Nucl. Radiochem. Sci. 2002. V. 3. P. 13.
11. *Bashevoy V. V. et al.* // Nucl. Phys. A. 2002. V. 701. P. 592c.

FRANK LABORATORY OF NEUTRON PHYSICS

In 2002, the FLNP scientific programme was realized under the auspices of five research themes of the JINR Plan of Scientific Research and International Scientific and Technical Cooperation (PSRISTC), and it was aimed at obtaining new results in condensed matter physics (theme «Neutron Investigations of Structure and Dynamics of Condensed Matter», headed by V. L. Aksenov and A. M. Balagurov) and neutron nuclear physics (theme «Nuclear Physics with Neutrons — Fundamental and Applied Investigations», headed by W. I. Furman and V. N. Shvetsov). To effect scientific research, work was continued to develop, modernize, and construct the FLNP basic facilities, IBR-2 (theme «Development and Upgrading of the IBR-2 Com-

plex», headed by V. D. Ananiev and V. P. Shabalin) and IREN (theme «IREN Project», headed by W. I. Furman and I. N. Meshkov) as well as the IBR-2 spectrometry and computation complex (theme «Development of the IBR-2 Spectrometers Complex and Computing Infrastructure», headed by A. V. Belushkin and V. I. Prikhodko).

Current topics of the investigations, carried out in collaboration with leading nuclear research centres, were considered and discussed at the X International Seminar on Interaction of Neutrons with Nuclei, JINR–Romania Workshop on Advanced Materials, II Workshop on Investigations at the IBR-2 Reactor.

CONDENSED MATTER PHYSICS

Diffraction. In 2002, as the investigations of the compound $(\text{La}_{1-y}\text{Pr}_y)_{0.7}\text{Ca}_{0.3}\text{MnO}_3(\text{LPCM-}y)$ [1, 2] continued, a series of neutron diffraction experiments to obtain information on the magnetic phase diagram of the compounds with the predominance of ^{18}O isotope (up to 75 %) were carried out. Their main result is that the phase diagrams of $\text{LPCM-}y/^{16}\text{O}$ and $\text{LPCM-}y/^{18}\text{O}$ are qualitatively identical (Fig. 1). This gives grounds to believe that the giant isotopic effect in electroresistance, observed earlier for the LPCM compound with $y = 0.75$, is a manifestation of a transition to another phase state.

The crystal and magnetic structures of the new layered complex manganese oxide $\text{Sr}_2\text{MnGaO}_{5+x}$ with an intermediate content of oxygen $x = 0.13$ and 0.41 (between the limiting values $x = 0$ and 0.5) were investigated. As was demonstrated earlier [3], in the limiting cases the magnetic structures differ significantly and

correspond to antiferromagnetic (AFM) G and C types for $x = 0$ and 0.5 , respectively. It turned out that while the composition with $x = 0.13$, as the temperature decreases ($T_N \approx 200$ K), undergoes a transition to a homogeneous antiferromagnetic state of G type (i. e., its behaviour is the same as of the composition with $x = 0$), in the composition with $x = 0.41$ magnetic phases of both G ($T_N \approx 140$ K) and C ($T_N \approx 110$ K) types with approximately equal concentrations appear (Fig. 2). The unusual fact is the lack of evidence of any structural differences in the two arising magnetic phases.

At the DN-12 spectrometer, the crystal and magnetic structures of manganites $\text{Pr}_{0.7}\text{Ca}_{0.3}\text{Mn}_{1-y}\text{Fe}_y\text{O}_3$ ($y = 0, 0.1$) [4] and $\text{Pr}_{0.8}\text{Na}_{0.2}\text{MnO}_3$ [5] with the CMR effect were investigated at pressures of up to 4.5 GPa and in the temperature interval of 16–300 K. For the first time it was found that in these compounds, which

have significantly different magnetic structures at a normal pressure ($\text{Pr}_{0.7}\text{Ca}_{0.3}\text{MnO}_3$ and $\text{Pr}_{0.8}\text{Na}_{0.2}\text{MnO}_3$ have the AFM structure of pseudo-*CE* type, while $\text{Pr}_{0.7}\text{Ca}_{0.3}\text{Mn}_{0.9}\text{Fe}_{0.1}\text{O}_3$ is ferromagnetic), stabilization

of the AFM state of type *A* with characteristic propagation vector $\mathbf{q} = (010)$ takes place at high pressures and low temperatures.

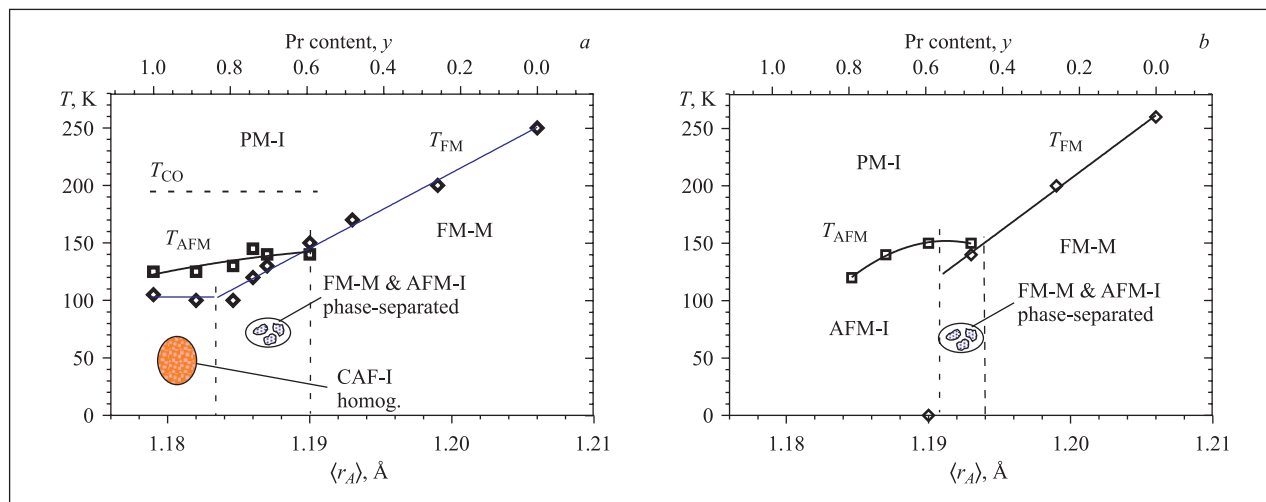

Fig. 1. Magnetic phase diagrams for the $(\text{La}_{1-y}\text{Pr}_y)_{0.7}\text{Ca}_{0.3}\text{MnO}_3$ compositions containing oxygen isotopes ^{16}O (a) and ^{18}O (b)

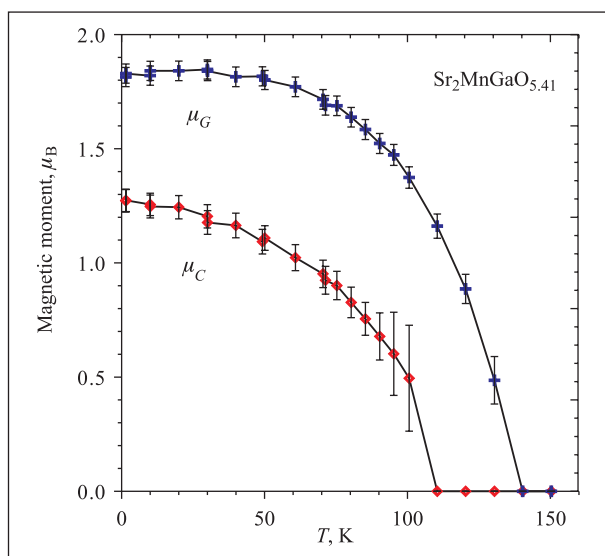

Fig. 2. Dependence of the value of magnetic moments in $\text{Sr}_2\text{MnGaO}_{5.41}$ on temperature. At $T \approx 140$ and 110 K two sequential magnetic phase transitions with the formation of the *G*- and *C*-type antiferromagnetic phases take place, i. e., magnetic phase separation develops

Small-Angle Neutron Scattering. Within the framework of studies of cluster state of fullerenes in solutions, the experiments on small-angle neutron scattering from the solution of C_{60} in carbon disulfide ($\text{C}_{60}/\text{CS}_2$) [6] and the colloidal solution of C_{60} in water (C_{60}FWS) [7] were performed. For the system $\text{C}_{60}/\text{CS}_2$ it was shown that the formation of small clusters with

a mean aggregation number of about four takes place in solution. The aggregation number does not depend on the temperature ($15 \div 30^\circ\text{C}$) and concentration ($4 \div 8$ mg/ml). These results cast doubt on the use of the drop model to describe the cluster structure in solution. In the case of C_{60}FWS , large polydispersity over a wide range of sizes up to 50 nm was revealed. The contrast variation based on different mixtures of light and heavy water points to the presence of a component in the aggregates, which is different from fullerenes. This component is assumed to be responsible for stabilization of the dispersions. A number of hypotheses about its origin, in particular, the formation of a specific hydration shell around fullerenes, are being discussed.

The conformation of the elongation factor eFF1A from mammal cells (rabbit) in solutions was investigated by means of small-angle neutron scattering and scanning microcalorimetry [8]. It was found that in contrast to a bacterial analogue the protein has no fixed structure in solution. This follows from the fact that the radius of gyration, 5.2 nm, determined from the small-angle scattering curves is considerably greater than that of the prokaryotic eEF1A, while the specific heat of denaturation of the studied eEF1A, 4 cal/g, obtained by the scanning microcalorimetry is significantly lower than 7 cal/g for the prokaryotic eEF1A calculated for the same denaturation temperature. The small-angle neutron scattering data suggest that the studied eEF1A becomes more compact when forming a complex with the diacyl-tRNA.

Polarized Neutrons and Neutron Optics. The reflectometry was applied to study the interface formation

during the synthesis of multilayers from the P(dS-b-nBMA) copolymers composed of blocks with different molecular weight [9]. It was found that the numerous peculiarities observed in the off-specular neutron scattering spectra are connected with the presence of islands or pores distributed at random on the film surfaces, as well as with the formation of complex interphase boundaries.

At the REFLEX-P spectrometer, the high-precision experiment to search for the surface magnetic excitations in magnetic thin film structures was continued [10]. A full set of experimental data has been collected, and work on creation of a mathematical model to treat the obtained results is in progress.

Inelastic Neutron Scattering. At the NERA spectrometer, the structural phase transitions and dynamics of solid mesitylene [11], as well as the influence of concentration and temperature on the dynamics of ammonium groups and phase transitions in mixed crystals $Rb_{1-x}(NH_4)_xBr$, were investigated. Mesitylene, known as an organic solvent with a comparatively low freezing point of 227 K, holds much promise for cold neutron sources. The results of simultaneous measurements of both the diffraction and inelastic neutron scattering demonstrated that the phase composition of solid mesitylene depends on the cooling rate; i. e., mesitylene

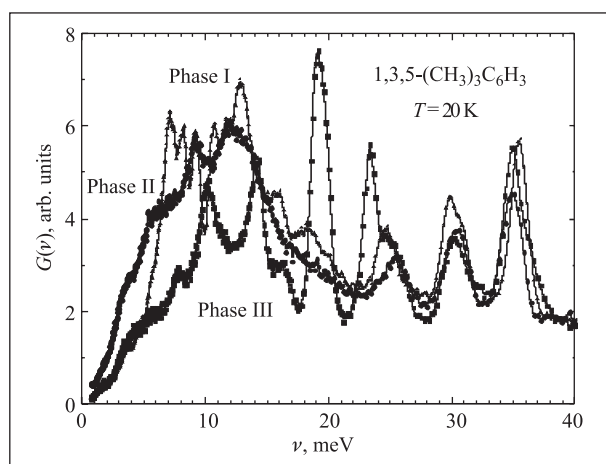

Fig. 3. Phonon state density in different structural phases of mesitylene

NEUTRON NUCLEAR PHYSICS

In the year 2002, the programme for experimental research in neutron nuclear physics of the Frank

is an interesting example of a relatively simple molecular crystal which exists at low temperatures in various structural modifications with significantly different dynamic characteristics (Fig.3). In the future this will make it possible to study the packing effect on the lattice dynamics and rotation dynamics of methyl groups.

The investigations of the crystalline electric field (CEF) effects in $RAgSb_2$, where $R = Ce, Tm, Er$ and Ho , were carried out by means of inelastic neutron scattering. The CEF parameters as well as the level schemes and wave functions were determined. The temperature dependence of magnetic susceptibility calculated for different crystallographic directions using the CEF parameters agrees well with the experimental results for monocrystals. The analysis shows that magnetocrystalline anisotropy in these compounds is determined mainly by CEF.

Applied Research. The diffraction study of textures of amphibolites and gneisses from the section of the super deep borehole SG-3 in Kola Peninsula and their analogues from the surface [12] continued. The modelling of the elastic wave speed distribution in the studied samples was conducted using the quantitative information on the texture and data on elastic modules of minerals forming rocks. The analysis of the obtained data will allow us to find out the contribution of the oriented mineral components to the total elastic anisotropy of rocks. This is necessary to establish regularities between texture peculiarities and deformation mechanisms, as well as metamorphic processes responsible for the texture formation in the process of evolution of lithosphere.

To explain the swelling mechanism in graphite blocks irradiated by neutron fluxes, a number of in-situ experiments were carried out to study changes in anisotropy in the samples of reactor graphite under the action of compression stresses. Investigations were performed both in elastic and plastic deformation regions. It was found that the graphite crystal lattice remains unchanged until stresses are close to the breaking stress value. It is possible that this unusual result can be connected with the initial porosity of the samples; i. e., the action of compression stresses reduces to the collapse of pores without significant elastic deformation of the crystal lattice. The obtained data will be verified on the graphite samples cut out from different places and variously arranged locations in the reactor block.

Laboratory of Neutron Physics covered the FLNP's traditional directions in fundamental and applied research

conducted on the beams of IBR-30, IBR-2 and EG-5 and in other nuclear centres in Russia, Bulgaria, Poland, Czech Republic, Germany, Republic of Korea, France, the USA, and at CERN.

Experimental Investigations. In 2002, experiments to search for the neutron subbarrier p resonance in lead isotopes that would explain the effects associated with spatial parity violation in the neutron–nucleus interaction, continued. On channel 1 of IBR-2, gamma spectra of radiative neutron capture in a sample of lead enriched with ^{204}Pb were measured with the gamma spectrometer COCOS [13]. The principal possibility of precision gamma spectroscopy of small quantities of lead isotopes in unfavourable background conditions of the pulsed neutron beam and the effectiveness of the chosen methodological approach were demonstrated. Preliminary results show no manifestation of such a resonance for a ^{204}Pb isotope within an accuracy of 15 %, which may be due to the existence of some additional prohibition of direct transition to the ground state of the compound nucleus for p resonances.

In 2002, experiments to measure neutron capture partial cross sections in the energy range of 5–100 keV by shifting the primary γ -transition energy as the energy of captured neutrons changes, continued. Radiative neutron capture gamma spectra were obtained with the EG-5 electrostatic accelerator on the nuclei of Cr, Zn, Cl. The processing of results is in progress.

The measurements of angular anisotropy of alpha particles from the decay of ^{233}U present as an impurity in the RUN (rubidium-uranyl nitrate) sample were performed to refine the constant of hyperfine splitting, which is used to determine the alignment of uranium nuclei. The desired accuracy ($\leq 10\%$) has not been achieved yet and measurements will be continued.

Within the framework of a new approach to the description of resonance-neutron-induced fission by using the helicity formalism and multilevel approximation, new equations were derived describing P -even and P -odd effects in the angular anisotropy of fragments. A programme was developed, which made it possible to analyze the experimental data on «forward-backward» and «left-right» anisotropy of fragments for ^{239}Pu using these equations and R -matrix formalism.

At CERN's nTOF neutron pulsed source, with the help of fast ionization chamber the first measurements of the $^{234}\text{U}(n, f)$ -reaction cross section for a wide interval of neutron energies (from thermal up to 100 MeV) were carried out. These measurements are conducted in the framework of the EC programme for nuclear data for accelerator-driven subcritical systems. At the same time, using a unique energy resolution of the nTOF spectrometer, the problem of studying fine structure of vibration resonances developed on the fission barrier of even-even target nuclei is being solved. The precise knowledge of parameters of this structure allows one to obtain quantitative information on deformation of fissionable nuclei in the point of discontinuity and in

this way to study the properties of an external fission barrier. In 2003, data are expected to be obtained for target nuclei ^{232}Th , ^{234}U , ^{236}U and ^{238}U .

The processing and analysis of the experimental data obtained with the ROMASHKA spectrometer on ^{235}U fission and capture cross sections, as well as on total cross sections and neutron scattering cross sections in the energy region from 0.1 to 200 keV for fission fragments of Nb, Mo and Pb were performed.

A facility to monochromatize thermal neutrons on the basis of a mechanical chopper with curved slits was developed and manufactured.

The analysis of results of the classical work by Cron and Ringo, 1966, to measure the n, e -scattering length b_{ne} was performed. The reliable signs were revealed that the effect of neutron diffraction in a monoatomic gas blends with the effect of n, e -interactions. That is why the obtained result in b_{ne} is not trustworthy. On the 11B beam of the IBR-2 reactor, neutron diffraction measurements in the energy range from ~ 0.006 to 0.07 eV on argon at 50 atm were started.

In 2002, the experiment «Study of UCN Small Energy Transfer Processes at the New Big Gravitation Spectrometer (BGS)» at the Institute of Laue Langevin (Grenoble, France) was carried out. The obtained results indicate that the nature of UCN small heating on surfaces of solid bodies is connected with UCN interactions with surface nanostructures. It was shown that, depending on the surface treatment, the magnitude of the effect may reach values at which UCN losses from traps become considerable. Therefore the interpretation of experiments where the channel of UCN losses due to their small heating is not measured explicitly is unreliable.

A series of experimental studies to develop UCN double differential spectrometry high-resolution methods, in particular, to study possible applications of these methods for nonmechanical modulation of the neutron flux were prepared and carried out at ILL (Grenoble).

In 2002, work to study the optics of strongly absorbing media was completed. The experiment was carried out using the UCN spectrometer with interference filters on the natural gadolinium samples. In this case the UCN absorption wavelength in matter $(\rho\sigma)^{-1}$ is of the order of the neutron wavelength. The obtained value of the imaginary part of gadolinium scattering length $\text{Im}(b)_{\text{UCN}} = (10.6 \pm 0.6)$ fm agrees well with the value $\text{Im}(b) = 10.4$ fm, derived from the radiative cold neutron capture cross section. These results show that the imaginary part of scattering length is constant or, which is the same, that the capture cross section of a single nucleus obeys the law $1/v$ for a velocity of incident neutrons of $4 \div \sim 120$ m/s with an accuracy of 6%. In addition, it was proved that the effective complex potential correctly describes the UCN interaction with strongly absorbing medium in the limiting case of the proximity of wavelength and attenuation length.

The above-mentioned results could not be obtained without knowing the value of a real part of scattering length $\text{Re}(b)$ of natural gadolinium. In the course of work the available literature data were analyzed, and it was revealed that they are incomplete and conflicting. At the IBR-2 reactor, measurements of the $\text{Re}(b)$ value for gadolinium were performed. The treatment of this value taking into account its resonance behaviour resulted in $b_0 = (11.5 \pm 0.7)$ fm for $\text{Re}(b) = b_0 + b(\lambda)$. The resonance contribution $b(\lambda)$ was calculated by the Breit-Wigner formula taking into account the resonances in the energy region of up to 3 eV. Hence it follows that for UCN $\text{Re}(b)_{\text{UCN}} = (5.8 \pm 0.7)$ fm. It was this value that was used in the processing of results from the experiment on UCN transmission through gadolinium films. Originally the employment of tabular data led to erroneous conclusion of anomalous behaviour of UCN capture cross section.

The UCN time-focusing experiment was started at the spectrometer with modified interference filters using a specially designed diffraction grating with a changeable period depending on the azimuth angle. The focusing effect was registered, the focusing efficiency, however, proved to be less than the calculated one. Reasons for this discrepancy are being cleared up.

Work to study the possibility of using the method of dynamic nuclear alignment (DNA) for investigation of the T -noninvariance in neutron-nucleus interaction using P -even T -odd quinary correlation was carried out. In cooperation with the Institute of General and Inorganic Chemistry the investigations of lutetium niobate monocrystal with a paramagnetic admixture of trivalent chrome were carried out using the NQR method. Three resonance lines corresponding to the transitions between levels with spins $7/2$, $5/2$, $3/2$ and $1/2$ were found. The transition frequencies differ slightly from those obtained earlier on ceramic sample. The relative positions of the direction of the electric field gradient and the main axis C of the crystal were determined. Modernization of Q -meter to measure the alignment values was performed. A variant of UHF system for DNA was prepared.

In the framework of FLNP-PAL (Pohang Accelerator Laboratory), POSTECH (Pohang, Republic of Korea) cooperation, measurements of total neutron cross sections of Ag, Sm, Dy (natural isotope mixtures) on the neutron beam at PAL were carried out. For Ag and Sm the parameters of neutron s -wave resonances in the range from 0.1 to 80 eV were obtained. The data were transferred to KAERI (Korean Atomic Energy Research Institute) for the subsequent treatment and inclusion into the library of neutron cross sections. The system of Helmholtz coils was created for carrying out experiments with polarized ^3He on the PAL neutron beams and HANARO reactor (KAERI).

In the framework of FLNP-PIRAS cooperation on the creation of the KaTRIn facility to investigate time invariance in the interaction of polarized neutrons with nuclei, work to improve the first variant of ^3He neutron polarizer with optical pumping was conducted. The programme for modeling the passage of polarized epithermal neutrons through polarized targets was developed.

The treatment and analysis of the accumulated experimental information on two-quantum cascades in the unexplored nuclei continue [14–16]. The analysis of these data for ^{60}Co and ^{184}W nuclei was completed. For compound nuclei $^{185,187}\text{W}$ and $^{191,193}\text{Os}$ from the intensities of two-quantum cascades, the intervals of the most probable values of level densities, which are excited by primary dipole transitions during thermal neutron capture, and their radiative force functions were determined. For tungsten isotopes the mentioned parameters of the neutron resonance cascade gamma decay were obtained with the least statistic and systematic error in comparison with the earlier obtained data.

Organization work and consultations to realize the proposal of carrying out the experiment to measure neutron-neutron scattering amplitude at the YAGUAR reactor (Snezhinsk), supported by ICST, were held. A laid tube (10 m of length) was manufactured to create a flight path under the YAGUAR reactor. The intensive modeling of experimental conditions is under way.

Applied Research. In 2002, work to study atmospheric heavy metal deposition using the biomonitoring technique, NAA and GIS technologies (REGATA project) for the territories in Central Russia (Tula, Tver, Yaroslavl regions and north of Moscow Region) and also in a number of European countries (Bulgaria, Slovakia, Romania, Ukraine, Poland, Serbia, Bosnia) continued. The results of these investigations were sent to the European Atlas, which is published under the auspices of the United Nations. Similar studies are conducted in cooperation with South Korea, China, Macedonia and Turkey. In November, 2002, the IAEA project on South Ural Region, aimed at assessing the contamination of Chelyabinsk Region by heavy metals and radioactive nuclides, was completed.

The impurity composition of artificially grown diamonds manufactured at the Institute of Solid State and Semiconductor Physics, the National Academy of Sciences of Belarus (Minsk), was studied.

In cooperation with a group of biophysicists from the Institute of Physics, Georgian Academy of Sciences, work to develop new pharmaceuticals on the basis of blue-green algae *Spirulina platensis* continued. Peculiarities of interaction of the microalgae with Cr(III) and Cr(VI), as well as combined effect of chrome and selenium on *Spirulina platensis* were investigated.

NEUTRON SOURCES

The IBR-2 Pulsed Reactor. In 2002, the IBR-2 reactor operated in accordance with the approved working schedule. It has operated 2000 hours in eight cycles for physics experiments.

In 2002, work on the IBR-2 reactor modernization project was continued.

- Movable reflector: test assembling of the manufactured parts (carriage, platform, technological frame, dismountable shielding) was performed; working assembling of the reduction gearbox was carried out.
- New fuel assembly: the manufacturing of PuO₂ pellets is in progress at the industrial enterprise «Mayak»; the manufacturing of the fuel assembly parts was started; the working design of a new jacket for the IBR-2M reactor was completed.
- Control safety system: a full-scale test-bench was created at FLNP to study the automatic emergency system (AES); investigations were started.
- Helium facility: engineering design of a special

helium facility for the cold moderator was completed. Detail designing is in progress.

The IREN Project. For the most part, the approved part of the IREN working project (GSPI), the working documentation of the multiplying target (NIKIET) and the technical project of the IREN control system, were completed. A large volume of design works on the main components of the LUE-200 electron linac was executed, the manufacturing of a number of units for LUE-200 was started and partially completed at JINR Experimental Workshop, LPP, VBLHE and other enterprises of Russia. The most part of the equipment to dismantle the IBR-30 reactor was designed (FLNP) and manufactured, the construction of building 117/6 intended to store activated elements of the reactor was completed in the main. Considering the delay and insufficiency of financing of works under the project, an average shift in execution of the plan of works in 2002 was about two quarters.

DEVELOPMENT OF THE IBR-2 SPECTROMETER COMPLEX AND COMPUTING INFRASTRUCTURE

In 2002, work under this theme was carried out in accordance with the FLNP projects: MCC, FSD, YuMO, Texture, SPN, as well as the BMBF-JINR projects: Detectors and ECS.

Main directions of activity are:

- development of the information and computing infrastructure;
- creation of data acquisition and control systems of the IBR-2 spectrometers;
- development of the IBR-2 spectrometer complex:
 - automation of spectrometers and development of sample environment systems;
 - creation of neutron detectors;
 - routine maintenance of spectrometers.

Local Area Network. In FLNP's local area network (LAN), the router of information flows CISCO 8510 was installed and put into operation. For direct connection of SUN-cluster servers via twisted pairs, an eight-port interface CISCO C85FE-8-16K was purchased. In buildings 117 and 44, high-speed commutators Catalyst 29XX (CISCO) were installed and connected to the central segment of the network via optical communication lines. All the network printers of FLNP that exhausted their resource were replaced. The logical reconfiguration of LAN was conducted and a change-over to new versions of the network software was carried out.

The completion of the first stage of the specified works on the LAN modernization allowed one [17]:

- to increase real throughput of the network by 50–60 % without changing physical interfaces;
- to provide mechanisms of control, analysis and filtration of the network traffic;
- to extend address space (at present, up to 4000 IP-addresses);
- to organize virtual subnetworks for groups of users (or spectrometers) irrespective of their geographical location (in 2002, four subnetworks were created: SEDNP, SEDNICM, SEDSC and IBR-2 reactor building);
- to provide a guaranteed passband for the most important network applications (for example, for concrete spectrometers).

Development and Routine Maintenance of the IBR-2 Spectrometer Complex. Work to modernize detector electronics and to optimize characteristics of the VME data acquisition systems at the IBR-2 spectrometers (DN-2, YuMO, DN-12, EPSILON) was performed.

In cooperation with HMI (Berlin) a new version of the unified TDC/DSP DAG block for acquisition and accumulation of data from position-sensitive detectors with delay-line data readout was developed and manufactured. In the block, the determination of X/Y coordinates of the event (by signals from both ends of the delay lines) and neutron time of flight from the reactor start to the moment of detection is executed; for the methodical purposes the amplitude of signals is

measured as well. Two main operating modes are provided: histogram (on-line sorting of data and building of spectra) and «list» (accumulation of raw data with subsequent off-line processing). It is also possible to simultaneously accumulate histograms (for controlling the experiment) and to write raw data. The TDC/DSP block has a PCI interface and is installed directly in the case of PC. At present, the adjustment of electronics and debugging of microprograms (DSP) of the block are under way.

For this block the architecture was developed, and the debugging of the prototype of the program driver was carried out. The driver provides interaction between the program modules of the low (DSP) and following (PC) levels for several variants of basic software packages: C++, PV-WAVE, ROOT.

New low-noise preamplifiers for MWPC and point detectors, and readout electronics for scintillation detectors ASTRA were developed. Four multiprocessor blocks of RTOF analyzers (16 channels) [18] were adjusted.

The development of the unified software for the Fourier diffractometers was completed, and its testing on FSD is in progress.

The concept of a new generation of the software for data acquisition and control systems of spectrometers on the basis of VME-PCI adapters [19] was worked out. The interface programs were developed, and their trial operation is carried out at the NERA-PR spectrometer.

For the SPN spectrometer, programs for positioning the polarizer and controlling current sources were developed. The open G2 program was supplemented by new possibilities for processing data from YuMO and SPN.

In the reported year, work to improve and provide service support of the software of the data acquisition and accumulation systems at all IBR-2 spectrometers was conducted.

At the YuMO spectrometer the system consisting of two ring replaceable collimators based on step motors under control of the program of experiment was put into operation.

Work to modernize the control systems of choppers based on microcontrollers was performed for the spectrometers: YuMO, HRFD, REFLEX (chopper and monochromator) and SPN (two choppers).

The closed cycle cryostat KGU801 for reaching a temperature of 4.2 K was developed. The cryostat KGU801 based on the two-stage cryogenerator RGD1245 makes it possible to obtain a constant temperature at the sample of about 4.2 K using the Joule-Thomson stage.

A high-pressure chamber of the «toroid» type for conducting neutron diffraction investigations of structure and lattice dynamics of condensed matter was created. The volume of a studied sample is 60–100 mm³. The chamber was graduated using the manganin pressure sensor and by the known equations of reference

material state. The maximum pressure in the chamber was 10 GPa, which is a record in lattice dynamics research.

In 2002, research and development of different types of neutron detectors for the IBR-2 spectrometers were carried out.

- For the FSD diffractometer, eight working elements of wide-aperture scintillation (ZnS) $\pm 90^\circ$ detector with time focusing ASTRA were produced, tested and put into operation. Tests have demonstrated a high quality of manufacture and complete compliance of detector parameters with the calculated values [20]. The solid angle of each module was increased by a factor of 2 as compared with the experimental model.
- To upgrade the detector system of the DN-12 spectrometer, the method of «rough» time focusing was suggested, which makes it possible to create economical detectors with a large solid angle for classical time-of-flight spectrometers with a large flight path. The method provides for a considerable solid angle with the help of economical small-area detectors. Thus, a high resolution of the spectrometer is ensured.
- Under the contract with IPM, RAS (Nizhnii Novgorod, Russia), microstrip structures with a «virtual cathode» were manufactured on special glass substrates (made of glass Schott S8900) with electron conductivity. The strip layout and coordinate readout using the division of charge from two ends of a resistive wire are analogous to the Bidim80 detector developed and constructed at ILL. These structures were tested at ILL. The results of the tests have demonstrated a high quality of the microstructures and their suitability for use in neutron detectors. At present, two glass substrates with microstrip structures manufactured at IPM are at ILL and will be used in the operating detectors to check their long-term characteristics. One substrate is installed in the body of the detector manufactured at FLNP and prepared for tests.
- In collaboration with EMBL and JINR's DLNP, the construction of a stand for creating proportional multiwire neutron detectors was started. The equipment to control the pitch of wire winding was purchased. The stand for testing MWPC detectors with delay-line data readout was equipped with electronics.
- The prototype of the medium-resolution multiwire detector with individual signal readout from every wire was designed and constructed. The detector working area is 8×8 cm.

In the reported year, the equipment of spectrometers was prepared for operation and serviced for conducting experiments in eight cycles of the IBR-2 reactor.

REFERENCES

1. *Balagurov A. M. et al.* // Phys. Rev. B. 2001. V. 64. P. 024420-1-10.
2. *Balagurov A. M. et al.* // Appl. Phys. A: Materials Science & Processing. 2002. V. 75.
3. *Pomjakushin V. Yu. et al.* // Phys. Rev. B. 2002. V. 64. P. 184412-1-13.
4. *Kozlenko D. P. et al.* // High Pressure Research (in press).
5. *Kozlenko D. P. et al.* // J. Phys.: Condensed Matter (submitted).
6. *Avdeev M. V. et al.* Study of colloidal solutions of fullerenes in water using small-angle neutron scattering // Book of abstracts, XVII Workshop on Applications of Neutron Scattering in Condensed Matter Investigations (RNICS-2002), PINP, Gatchina, October 14–19, 2002. Gatchina, 2002. P. 164.
7. *Tropin T. V. et al.* Study of colloidal solutions of fullerenes in water using small-angle neutron scattering // Ibid. P. 172.
8. *Budkevich T. et al.* // Biochemistry (in press).
9. *Lauter-Pasyuk V. et al.* // Appl. Phys. A: Materials Science & Processing (in press).
10. *Korneev D. P., Bodnarchuk V. I., Yaradaikin S. P.* Detection of surface phonons and magnons in thin-film structures. Current state and prospects // Book of abstracts, II Workshop on Investigations at the IBR-2 Reactor, Dubna, June 17–19, 2002. Dubna, 2002. P. 127.
11. *Natkaniec I., Holderna-Natkaniec K.* Structural phase transitions and dynamics of solid mesitylene investigated by diffraction and inelastic neutron scattering methods // Proc. of ACoM6 Meeting. ESS-FZ Juelich, 2002 (in press).
12. *Ivankina T. I. et al.* // Fizika Zemli (submitted).
13. *Andrzejewski J. et al.* How to explain parity violation effect in lead? // Neutron Spectroscopy, Nuclear Structure, Related Topics: X Intern. Seminar on Interaction of Neutrons with Nuclei, Dubna, May 22–25, 2002. Dubna, 2003. P. 19.
14. *Vasiljeva E. V., Sukhovej A. M., Khitrov V. A.* // RAS Trans., Ser. Phys. 2002. V. 66, No. 5. P. 674–679.
15. *Vasiljeva E. V., Sukhovej A. M., Khitrov V. A.* // Ibid. P. 674–679.
16. *Vasiljeva E. V., Sukhovej A. M., Khitrov V. A.* // Ibid. P. 680–684.
17. *Astakhov Yu., Prikhodko V., Sukhomlinov G.* Development of the information and computing infrastructure of the IBR-2 complex // 2nd Workshop on Investigations at the IBR-2 Reactor, Dubna, June 17–19, 2002. Dubna, 2002. P. 133.
18. *Bogdzal A. et al.* // Ibid. P. 137.
19. *Kirilov A. S.* Current state of the Sonix — the IBR-2 instrument control software and plans for future developments // NOBUGS Workshop, Gaithersburg, USA, Nov. 4–6, 2002, <http://arXiv.org/abs/cs.HC/0210014>.
20. *Kuzmin E. et al.* // J. Neutr. Research. 2002. V. 10 (1), P. 31–41.

LABORATORY OF INFORMATION TECHNOLOGIES

The main problems of the Laboratory of Information Technologies in 2002 were related to provision of the reliable operation and development of the JINR's network telecommunications and to the software and computer support of the scientific research which is under way at the Institute in the framework of the research field «Networks, Computing, Computational Physics».

In 2002, the LIT scientific programme was determined by three first-priority topics of the Topical Plan for JINR Research and International Cooperation. The employees of the Laboratory were also involved in research on 12 topics at a project level and in other 14 topics at a cooperation level.

In 2002, LIT was an organizer of the Vth International Congress on Mathematical Modelling (V ICMM), the 4th All-Russia Conference on Digital Libraries (RCDL'2002), international workshop «Quantum Physics and Communication», the 9th international conference «Mathematics. Computer. Education».

In 2002, four scientists received a Doctor of Science degree and three received a Candidate of Science degree at LIT.

A series of work «Statistical Model of Information Traffic» was rewarded the JINR Second Prize for 2002.

EXTERNAL TELECOMMUNICATION CHANNELS

In 2002, the JINR external computer communication channel of 30 Mb/s for the Russian Internet segment

and of 10 Mb/s for international computer networks demonstrated its reliable performance across the RBNet

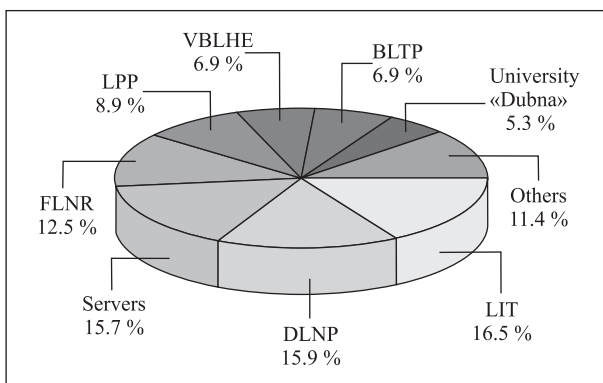

Fig. 1. Incoming traffic distribution over JINR divisions (> 5%)

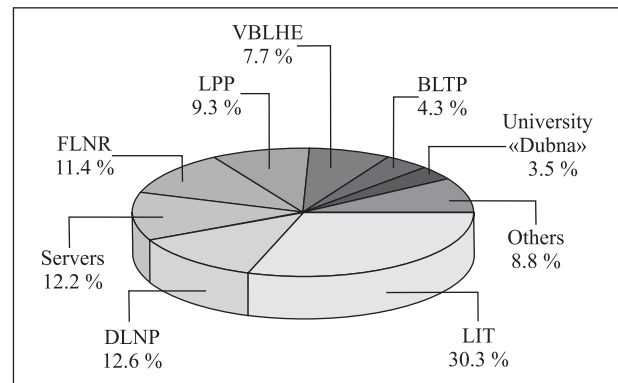

Fig. 2. Outgoing traffic distribution over JINR divisions (> 3%)

network using the TELIA and STARTAP channels. For the year 2002, the incoming traffic reached 9.72 TB (4.14 TB in 2001) (Fig. 1), outgoing — 1.9 TB (Fig. 2).

The further development of the JINR's external communications is connected to implementation of the interdepartmental programme «Creation of a National Scientific Computer Network of the New Generation

for 2002–2006» and the Russian GRID-segment. The first project has been implemented in the framework of creation of the JINR corporative computer network in cooperation with the RSCC «Dubna», a computer network for JINR's Crimean resort «Dubna» was mounted and adjusted in Alushta. Thus, a computer link and conditions for teleconferencing were provided for the participants of three international forums.

JINR LOCAL AREA NETWORK

In 2002, the reliable operation of the Fast-Ethernet-technology-based JINR Local Area Network (LAN) was provided (Fig. 3). There are 4053 network elements incorporated in the JINR LAN at present (there were 3451

in 2001), including 113 general-purpose and specialized servers. 821 home PCs are connected to the JINR modem pool.

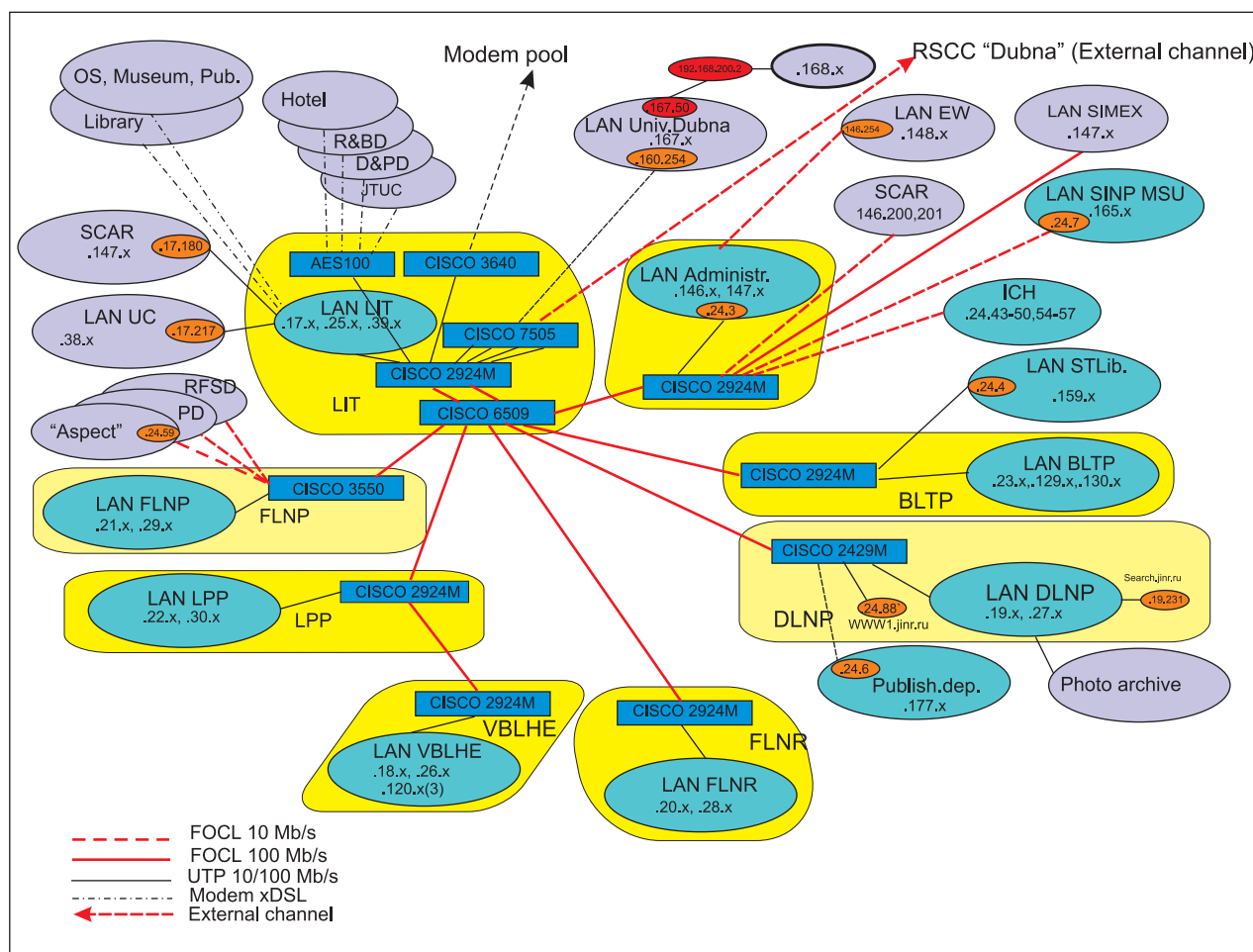

Fig. 3. JINR Local Area Network

Distributed Information Systems, JINR Central Computing Complex

The development of the JINR Central Computing Complex (CCC) was in progress on the basis of general-purpose and specialized clusters and computer farms. A distributed PC/Linux cluster has been installed at JINR CCC. The cluster comprises four separate interconnected components of various hardware nature and functional purposes. It includes an interactive farm of four dual-processor PCs Pentium III 1 GHz, 512 MB RAM, where the basic mathematical and special-purpose software, required for computations in the framework of several experiments, has been installed. The cluster also comprises specialized computing farms: a general-purpose farm, an LHC (Large Hadron Collider) farm, and a parallel computation farm. The computing general-purpose farm has eight dual-processor PCs Pentium III 500 MHz, 512 MB RAM. The LHC farm comprises 16 dual-processor PCs Pentium III 1 GHz, 512 MB RAM. The parallel computation farm includes eight dual-processor PCs Pentium III 1 GHz, 512 MB RAM connected by the communication network Myrinet 2000. Besides the general cluster, there are a number of specialized servers. The total

general-purpose cluster's performance is almost 2500 SpecInt95.

The distributed file system AFS provides a transparent and protected access to the common disk space for information storage for the users of the JINR LAN and for all participants of international collaborations and projects of JINR. The total capacity of the JINR CCC disk space is 6 TB. The 15-TB automated tape library is used for the long-term storage of enormous information arrays and for the backup copying system (Fig. 4).

In 2002, work on creation of the JINR's GRID-segment and its incorporation in the global GRID structure was in progress. First steps towards creating a system of the global monitoring of the resources of the large-scale GRID-LHC virtual organization including the LAN segments of several institutes (MSU SINP, JINR, SSC RRC «Kurchatov Institute», RAS KIAM) in accordance with the GRID-architecture were initiated. The monitoring system operates in a test mode, its experimental use for simulation and analysis of simulated data for the experiments CMS, ALICE, and ATLAS was carried out. First results on practical application of the hierarchical mass-storage control system in the GRID-LHC virtual organizations with optimal use of the backup resources, fragmentation and replication of data were obtained.

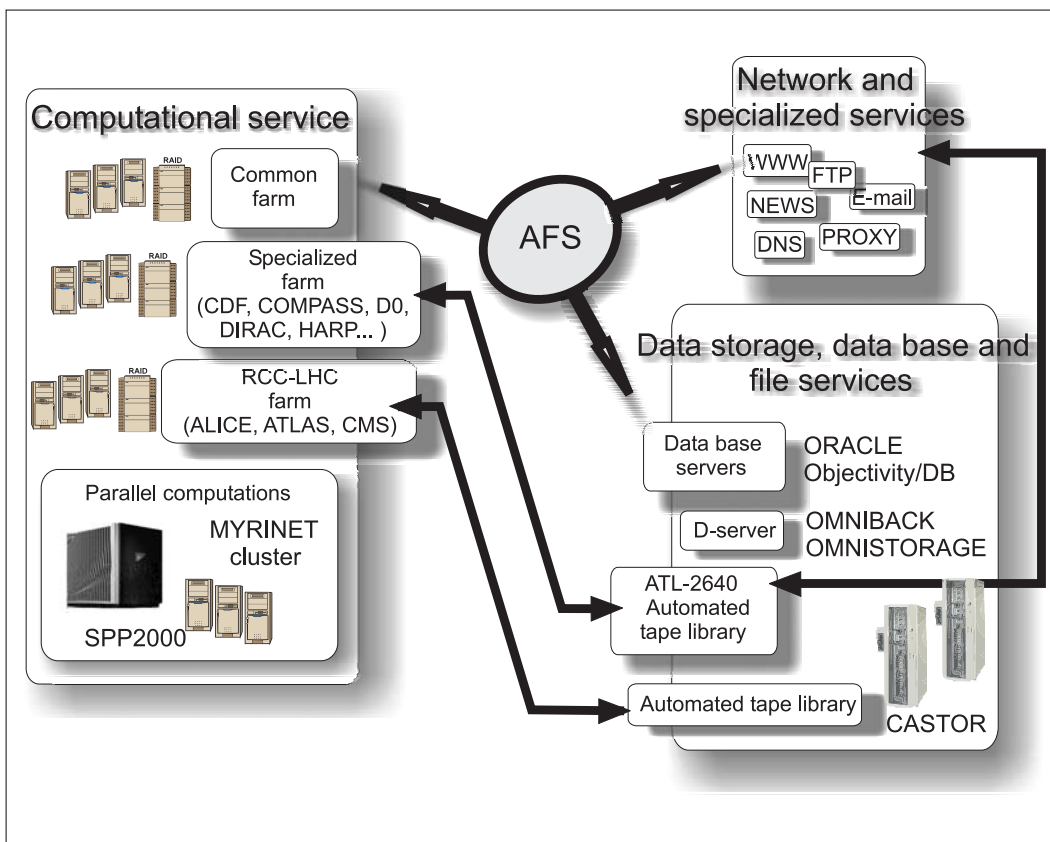

Fig. 4. Services at the JINR computing centre

COMPUTING SERVICE, DATABASES AND WWW-TOOLS

Mass event production runs for the CMS experiment were prolonged in 2002. More than 110 000 physical events with a possible production of electrons, photon and hadron jets were generated at the specialized farm of the JINR CCC. The size of the generated data reached 25 % of the total number of events generated by the Russian participants of mass event production runs (MSU SRINP, ITEP, IHEP, MSU Research Computer Centre). The participants of the autumn session of the mass event production for CMS were also CERN, Italian and French physics centres, the CMS distributed GRID-Centre in the USA.

A series of works within the projects LHCb, DIRAC, and DUBTO has been performed, including:

- for the LHCb project, java-units and programs of the simulation system for the first-level trigger of the LHCb installation were designed;
- for the DIRAC project, a new version of the program for simulation GEANT-DIRAC V2.61 was put into operation;
- for the DUBTO project, based on the GEANT package a program was designed to simulate various channels of $\pi^+4\text{He}$ interaction in the experimental set-up.

COMPUTATIONAL PHYSICS

In 2002, computer simulation methods and software for data processing were developed on the basis of new methods of information filtering, compression and visualization, and image recognition [1].

An effective algorithm for selection of useful events based on a multilayer feed-forward neural network was proposed and applied to simulated and real data analysis for the DUBTO experiment [2].

A series of works on the development of a statistical model of information traffic has been completed on the basis of a detailed study of its main features. The detailed nonlinear analysis of measurements of the information traffic was performed for the first time. It shows that the aggregation of these measurements (Fig. 5) forms a statistical distribution, which is approximated with a high accuracy by the log-normal distribution (Fig. 6). The log-normal distribution of the traffic measurements and their multiplicative character (Fig. 7) confirm that the scheme developed by A. Kolmogorov for the homogeneous fragmentation of grains can also be applied to the network traffic. The developed model provides a basis for creating new ef-

The maintenance and support of the information WWW-servers of JINR and LIT (<http://www.jinr.ru>, <http://lit.jinr.ru>) was continued. Necessary work on software support and centralized support of databases of a scientific and administrative type was fulfilled. The general-purpose and specialized libraries were maintained on the JINR's computer platforms. The filling and possibilities were extended on using the JINRLIB library based on programs created or adapted by JINR employees. The library was tested on the platforms SPP, Convex, Windows 9x/NT/2000/, versions for computer platforms Linux and FSF (GNU) were prepared, what is important in view of change-over to the use of the tools of Linux-clusters at the LIT general-purpose computer centre. In 2002, the content of the library was enlarged by 20 new programs mirroring a wide spectrum of the JINR's scientific tasks. A Web-page was prepared for the JINRLIB, providing electronic access to the descriptions of programs and rules of their usage in case of compilers calls. The modern state of the JINR program libraries is shown on the web-page: <http://www.jinr.ru/~tsap/Koi/sss.htm>.

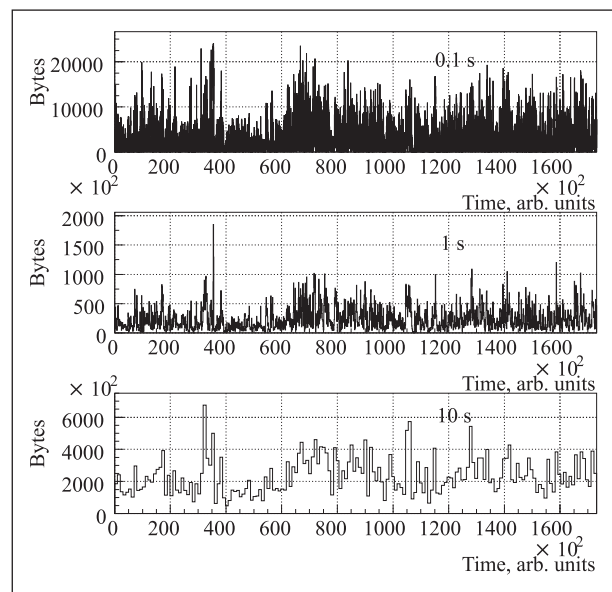

Fig. 5. Traffic measurements aggregated with different sizes: 0.1, 1 and 10 s

fective tools for optimal control over the traffic in computer networks, increasing data flows and decreasing information loss. It also provides new possibilities for implementation of traffic monitoring and for computer networks protection against unauthorized intrusions [3].

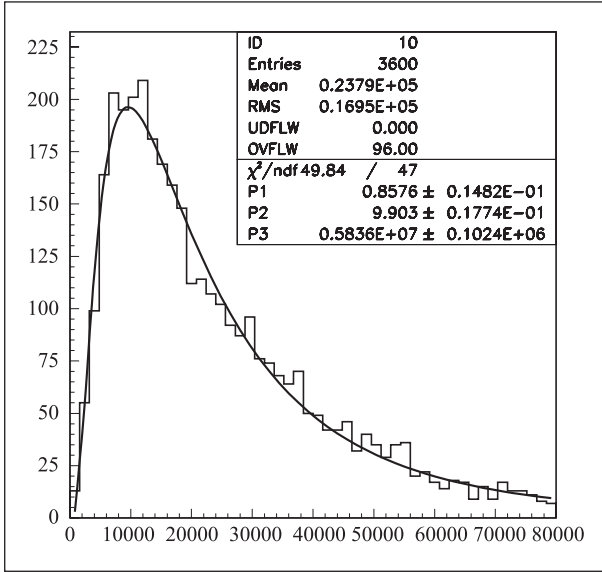

Fig. 6. Packet size distribution for daily traffic measurements aggregated with 1 s window: fitting curve corresponds to the log-normal function

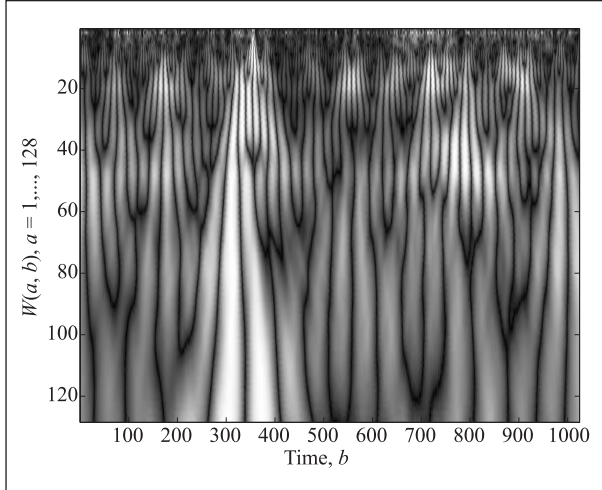

Fig. 7. Shade plot of the continuous wavelet transformation coefficients for traffic measurements aggregated with 1 s window

Algorithms and software have been developed for the analysis of angular distributions of secondary particles with the help of wavelet transformations (WASP), for data filtering with the use of a lifting scheme (WALF), for experimental data fitting (FITTER) [4].

One of the results obtained in 2002 is related to creation of a distributed CHARM system for data processing and data storage in the field of particle physics. The

hard- and software complex, based on the local Linux-cluster RISK-2002, the LPP computer farm, and the robotized central mass memory, is used for processing of simulated information and experimental data obtained from the EXCHARM set-up [5].

A mathematical procedure was developed to calculate the probability of generating a compound nucleus at nuclei interaction in reactions with heavy ions within the model of the double nuclear system, created at FLNR and developed at BLTP [6].

Analytical and numerical methods have been developed to model the electromagnetic activity of a paramagnetic neutron star. The periods of nonradial torsional pulsations have been studied analytically and numerically [7]. The model is currently used in interpreting observational data on pulsars and magnetars.

In the framework of the development and application of algorithms and software for numerical research in the heavy ion relativistic collisions, a combination of the quantum molecular dynamics model and the evaporation model of de-exciting nuclei describes well the spectra of secondary protons and neutrons up to the energies of striking particles ~ 300 MeV [8]. Investigation on colour transparency, exotic nuclei properties, fragmentation and multifragmentation processes in hadron and nucleus–nucleus collisions was performed [9].

A high-accuracy approximation method for linear evolutionary operators in Hilbert space has been created and theoretically proved. The method is based on discretization of the time variable of the original equation with the help of Magnus expansion for evolution operator and subsequent approximation of this expansion by rational functions of stability [10].

New variation-iteration algorithms were constructed and implemented in the FORTRAN language for solving with a predetermined accuracy the bound state problems and three quantum particle scattering problems with point or Coulomb pair interactions in the adiabatic representation. A numerical analysis and testing of the designed algorithms on the models of three quantum particles with point interactions and for the study of the transfer ionization reactions at supersmall scattering angles have been performed [11].

An analysis of relativistic field-theoretical equations was presented for photon–proton scattering reactions [12]. The numerical solutions of these equations were compared to new experimental data for reactions with $\gamma\Delta \rightarrow \pi p \gamma$ final states. A generalization for the inverse scattering problem was considered.

The interlacing operator technique is applied to discrete equations. It allows one to generate new families of precisely solved Jacobi matrices. It shows that the obtained thus Jacobi matrices lead to new precisely solved nonlocal potentials of the Schrödinger equation [13]. Discrete algebraic Darboux transformations and a factorization procedure have been obtained for a system

of coupled Schrödinger equations, permitting generation of series of potential matrices with predetermined spectral characteristics for which the system of discrete Schrödinger equations has precise solutions [14].

A program [15] has been worked out for a numerical solution of the system of partial differential equations, describing the energy relaxation in the vicinity of an ion trajectory moving in a substance and in the field of a pulsed energy release stipulated by slowing down the ion beams in the substance. A mathematical model of radiation damages appearing in a number of radiation-stable insulators has been constructed.

A new method [16] for computing the coil potential in modelling the 3D nonlinear magnetic fields, which does not result in accumulation of errors, was suggested. The method has been developed on the basis of field measurements of data for the EXCHARM experiment.

Some topics on applicability of the involutive bases technique to optimization problems of integer programming were considered. Restrictions have been revealed with the help of computer experiments, and some ways of modifying the involutive approach directed at overcoming these restrictions have been planned [17].

The designed original algorithms and software were applied to investigate the mechanical model for $SU(2)$ gauge theory. It was found out that, in contrast to the instant form of this mechanical model, its light-cone version possesses not only the first-class constraints but also the second-class ones [18].

A new much more effective algorithm of calculating cohomologies has been proposed which is based on splitting large cochain complexes into minimally possible subcomplexes [19].

INTERNATIONAL COOPERATION

According to the Cooperation Agreement between JINR and the research centre FZR (Rossendorf, Germany), a series of investigations has been conducted, the main direction of which was the choice, analysis and testing of new technologies to create information distributed systems, in particular, for organization of access to relational databases [24].

In cooperation with CERN, monitoring tools were developed for computing clusters with a large number of nodes (10 000 and more) used in the EU DataGrid infrastructure. In the framework of the task on Monitoring and Fault Tolerance, an event correlation system (Correlation Engine) is being created. The task of the system is a timely detection of anomalous states on cluster's nodes and taking precautions to prevent failures. With the help of the created Correlation Engine

Some procedures of semiclassical quantization of normal forms based on the algebraic perturbation theory were implemented in Reduce and included in the QUANTGIT computer program. This program is a core of the software complex oriented to simulation of dynamic and atomic systems in external fields [20].

The electronuclear systems consisting of two «cascade» subcritical assemblies, a liquid metal reactor on fast neutrons used as a booster, and a thermal reactor, where main heat production takes place, were simulated by the Monte-Carlo method. Reactors of VVER-1000, MSBR-1000, and CANDU-6 types are considered. The research results show that the two-reactor systems with an enriched uranium booster and a liquid cadmium valve are the most effective ones from the viewpoint of high output characteristics and safe functioning [21].

An urgent problem of nuclear waste transmutation and discussion of various approaches and methods of transmutation of the isotopes, which, in view of their high radioactivity and migrations in the biosphere, require obligatory transmutation, were considered in review [22].

The modern state of research in the area of computer simulation of physical and biological systems by molecular dynamics methods (MD) is given in review [23]. Special features of computer simulation of molecular and atomic systems based on parallel and vector calculations were analyzed. On the basis of application of methods of the MD simulation, calculations have been done allowing a dynamics analysis of condensed systems (clusters, liquids, etc.) and nuclei phenomena at a molecular level.

Prototype, statistics is being accumulated on anomalous states of nodes based on the CERN computing clusters. The prototype has been installed for statistics accumulation at the computing clusters at CERN and JINR.

In cooperation with CERN and the Brookhaven National Laboratory, work was in progress on:

— development of the object-oriented software environment (framework ROOT) for the solving of a wide range of scientific problems using workstations and personal computers (<http://root.cern.ch>) [25];

— elaboration, development and implementation of an information model of processes of acquisition, reconstruction and physical analysis of data for large experiments;

— introduction (together with the BLHE) of modern object-oriented technologies for the STAR experiment.

Within the joint DFG–GSI–JINR project «Nonequilibrium Strongly Dense Matter in Nucleus–Nucleus Collisions», work was continued on creating the software for numerical research on heavy ions collisions in the framework of a hydrodynamic model for various type equations of nuclear matter state. With the help of the designed software, in cooperation with physicists of JINR BLTP and the Kurchatov Institute, possible manifestations of the quantum chromodynamics (QCD) deconfinement phase transition in heavy ion collisions [26] were investigated.

APPLIED RESEARCH

In 2002, the cooperation with the International Solvay Institute for Physics and Chemistry (Brussels, Belgium) was continued in the field of applied research, which included:

- Investigations on the econophysics problems were performed. A new approach to the effective resources distribution has been developed, and a modification of the Cox–Ross–Rubenstein discrete model has been suggested which takes into account changing options prices depending upon percent rates [28].

- On the basis of elastic neural nets, new algorithms of solving the travelling salesman problem for a set of cities with known optimal tours [29] were developed.

- A simple and effective method has been suggested to find an initial approximation of an earthquake epicentrum based on the elastic neural net application [30].

- Generalization of the optical coherence tomography (OCT) images filtration algorithm has been obtained. It was developed to filter the OCT group images measured on the same skin area [31].

In cooperation with scientists from the Technical University of Kosice (the Slovak Republic) and the Laboratory of Computational and Statistical Physics of Academia Sinica (Taiwan), research on the mathematical modelling of proteins folding was continued [32]:

- An effective analytical algorithm has been developed for calculating the solvent excluded volume and the solvent accessible surface area of a protein molecule.

- Effective multigrid algorithms for the numerical solving of a boundary-value problem for the nonlinear Boltzmann–Poisson equation, which describes the electrostatic potential of the protein molecule in the solvent.

A FORTRAN code implementing the mentioned algorithms has been created and tested on the Linux clusters. The parallel version of the code was also created using the MPI package.

In the framework of the Cooperation Agreement between JINR and Cape Town University, a nonlinear Schrödinger equation with defocusing nonlinearity, the localized solutions among of which are «dark» solitons (domain walls), was under study [27].

In 2002, the cooperation with the International Solvay Institute for Physics and Chemistry (Brussels, Belgium) was in progress. A series of investigations was devoted to research in the information traffic [3].

REFERENCES

1. *Ososkov G. A., Polanski A., Puzynin I. V.* // Part. & Nucl. 2002. V. 33, issue 3. P. 676–745.
2. *Bonushkina A. Yu., Ivanov V. V., Pontecorvo G. B.* // Part. Nucl., Lett. 2002. No. 2 [111]. P. 39–44.
3. *Akritas P. et al.* // Chaos, Solitons & Fractals. 2002. V. 14(4). P. 595–606;
Antoniou I., Ivanov V. V., Kalinovsky Yu. L. // Physica A. 2002. V. 308. P. 533–544;
Antoniou I. et al. // Physica D. 2002. V. 167. P. 72;
Antoniou I. et al. // Nucl. Instr. Meth., Phys. Res. (submitted);
Antoniou I. et al. // Physica D (submitted);
Antoniou I. et al. // Physica A (submitted).
4. *Soloviev A. G. et al.* <http://www.jinr.ru/~tsap/Koi/jinrlib/xu007/Xu007.htm>;
Soloviev A. G. // <http://www.jinr.ru/~tsap/Koi/jinrlib/xu008/Xu008.htm>;
Soloviev A. G., Stadnik A. V. // <http://www.jinr.ru/~tsap/Koi/jinrlib/xx010/Xx010.htm>.
5. *Aleev A. N. et al.* Inclusive Production of Antihyperons in nC Interactions // Eur. Phys. J. C (in press).
6. *Zhidkov E. P., Lobanov Yu. Yu.* // Proc. of Institute of Mathematics NANB. 2002 (in press).
7. *Bastrukov S. I. et al.* // J. Exp. Theor. Phys. 2002. V. 95, No. 5. P. 789–799;
Bastrukov S. I., Yang J., Podgainy D. V. // Monthly Notices of the Royal Astron. Soc. 2002. V. 330, issue 4. P. 901–906;
Bastrukov S., Yang J. // Physica Scripta. 2002. V. 65, No. 4. P. 340–344.
8. *Polanski A., Uzhinsky V. V.* // Proc. of the 6th World Multiconf. on Systemics, Cybernetics and Informatics, Orlando, Floryda, USA, July 14–18, 2002. P. 79–89.

9. *Musulmanbekov G., Al-Haidary A.* nucl-th/0206054; *Yad. Fiz.* (in press).
10. *Selin A. V.* // *J. Comp. Math. & Math. Phys.* 2002. V. 42, No. 7. P. 937–949.
11. *Chuluunbaatar O., Puzynin I. V., Vinitsky S. I.* // *J. Comp. Meth. Sci. Eng.* 2002. V. 2. P. 37–49;
Chuluunbaatar O. et al. // *J. Phys. A.: Mathematical and General.* 2002. V. 35. P. L513–L525;
Popov Yu. V. et al. // *JETP.* 2002. V. 122. P. 717–722;
Serov V. V. et al. // *Phys. Rev. A.* 2002. V. 65. P. 062708-1-7.
12. *Machavariani A. I.* // *Phys. Lett. B.* 2002. V. 540. P. 81.
13. *Samsonov B. F., Suzko A. A.* // *Phys. Lett. A.* 2002. V. 302. P. 234.
14. *Suzko A.* // *Phys. At. Nucl.* 2002. V. 65, No. 8. P. 1553.
15. *Ayrjan E. A. et al.* // *J. Comp. Meth. Sci. Eng.* 2002. V. 2, No. 1–2. P. 163–168.
16. *Zhidkov E. P., Yuldashev O. I., Yuldasheva M. B.* // *J. Comp. Math. & Math. Phys.* 2002. No. 12.
17. *Gerdt V. P.* // *Programming.* 2002. V. 28, issue 2. P. 62–65;
Gerdt V. P. // *J. Math. Sci.* 2002. V. 108(6). P. 1034–1051.
18. *Gerdt V. P., Khvedelidze A. M., Mladenov D. M.* // *Comp. Algebra and Its Application to Phys.* 2002. P. 83–92; *Khvedelidze A. M. et al.* // *Eur. Phys. J. C.* 2002. V. 24. P. 137–141.
19. *Korniyak V. V.* // *J. Math. Sci.* 2002. V. 108(6). P. 1004–1014.
20. *Uwano Y. et al.* // *J. Comp. Meth. Sci. Eng.* 2002. V. 2. P. 271–275.
21. *Bznuni S. A. et al.* // *Ibid.* No. 1–2. P. 21–29;
Bznuni S. A. et al. // *At. Energy.* 2002. V. 92, issue 5. P. 344–351;
Bznuni S. A. et al. // *Ibid.* V. 93 (in press).
22. *Bznuni S. A. et al.* // *Part. & Nucl.* 2003. V. 34, No. 4 (in press).
23. *Kholmurodov K. et al.* // *Part. & Nucl.* (in press).
24. *Galaktionov V. V.* // *JINR Commun.* P11-2002-63, P11-2002-82. Dubna, 2002.
25. *Fine V.* // *ROOT 2002 Intern. Workshop, Geneva, 2002;* ftp://root.cern.ch/root/R2002/Valerin_ROOT_Qt_Presentation.pdf.
26. *Ivanov Yu. B. et al.* // *Heavy Ion Phys.* 2002. V. 15. P. 117–130.
27. *Barashenkov I. V., Woodford S. R., Zemlyanaya E. V.* // *JINR Preprint E17-2002-158.* Dubna, 2002; *Phys. Rev. Lett.* (submitted).
28. *Antoniou I. et al.* // *Physica A.* 2002. V. 304. P. 525–534;
Antoniou I., Ivanov V. V., Kryanev A. V. // *J. Comp. Meth. Sci. Eng.* 2002. V. 2, No. 1–2. P. 105–109.
29. *Antoniou I. et al.* // *Ibid.* P. 111.
30. *Antoniou I. et al.* // *Discrete Dynamics in Nature and Society.* 2002. V. 7, No. 1. P. 1.
31. *Akishin P. G. et al.* // *J. Comp. Meth. Sci. Eng.* 2002. V. 2, No. 1–2. P. 117.
32. *Ayrjan E. A. et al.* *JINR Commun.* E11-2002-292. Dubna, 2002.

DIVISION OF RADIATION AND RADIOBIOLOGICAL RESEARCH

The activity of DRRR in 2002 was concentrated on the three main directions: radiobiological research and radiation genetics, radiation research and radiation protection at the basic nuclear facilities of JINR and environment. Two first directions are included in the

Topical Plan for Scientific Research of JINR as a first-priority theme. Besides, the MITRA project on development of the new radiopharmaceuticals for target therapy of human melanoma is realized in the framework of the theme.

RADIATION RESEARCH

The comparison of evaluation and experiment for nuclear cascade induced by 650-MeV protons in the core of subcritical assembly driven by the DLNP Phasotron (SAD project) is completed [1]. Preliminary work for prognostication of the radiation environment at the planned installation is started.

The investigation of the neutron yield from the extended heavy ($Z \geq 82$) targets under irradiation by the Nuclotron proton beams with energies of about 1 GeV is continued [2].

The estimation of the radiation efficiency of the local shields of the scarpers in the 1st and 2nd sections of LAE-200 (IREN project) was carried out. The radiation parameters of a device to measure ion currents in external beams of the DC-72 cyclotron, which is being created for the Cyclotron Centre of the Slovak Republic, were done. The comparison of the neutron effective dose evaluations produced by the Monte-Carlo code and by the phenomenological method showed the acceptable accuracy of the engineering method up to 3 m shield thickness.

Activity in the framework of the FLNP and the Institute for Space Research (Moscow) collaboration concerning the Russian part of the MARS ODYSSEY project was continued. The calculation of the HEND detectors sensitivity in assembly was

performed. The albedo neutron spectrum from the GSR on the spacecraft orbit as well as the albedo spectra near the Martian surface (with different mixture of water) due to GSR and ^{252}Cf radiation were evaluated.

The neutron efficiency of the thermal neutron detectors within moderators and the neutron lifetimes in them were calculated for the experiments at the powerful pulsed accelerators [3]. Part of the experimental data on the measurement of the deuteron energy distribution in $d+d \rightarrow {}^3\text{He}+n$ reaction at ultralow deuteron collision energies was processed [4].

The calculation of some parameters of the device for identification of complex chemical substances by the nuclear physics methods was done.

The results of the comparison of different passive detector systems used for space dosimetry at the ICCHIBAN (Japan) beams of ${}^4\text{He}$, ${}^{12}\text{C}$, ${}^{28}\text{Si}$ and ${}^{56}\text{Fe}$ ions with energies of 150, 400, 490 and 500 MeV/nucleon accordingly were processed. The nuclear track detector (PADC and PETF) responses study was continued at the JINR accelerators.

Two runs of the radiobiological experiments at the Nuclotron beams (protons with an energy of 1 GeV and ${}^{24}\text{Mg}$ ions with an energy of 0.5 GeV/nucleon) were carried out.

RADIOBIOLOGICAL RESEARCH

The chromosome damage induction by low doses of radiation was studied in mammalian cells exposed to ^{12}C ions and γ rays. Determination of the shape of the dose-effect curve at the range of low doses is very important for prognoses of genetic and carcinogenic risk of radiation. Usually, for this kind of prognoses linear extrapolation of high-dose effects to low doses is used. Recently, the specific features of low radiation dose action have been demonstrated. In our experiments, complex nonlinear dose-effect dependence has been shown for induction of cells with chromosome damage [5, 6]. It is evident that the extrapolation of high-dose effects to low-dose range is incorrect.

We showed that irradiation of mammalian cells with ^{12}C ions in the dose range 1.3–40 cGy led to the decreasing number of chromosome damages below the control level. Probably this effect could be the result of repair of some spontaneous chromosome aberrations. In contrast, the number of damaged cells induced by γ irradiation exceeded the control values already at doses of 1.3–5 cGy and then increased nonlinearly with the dose. Thus, it can be concluded that inducible repair processes in cells irradiated with ^{12}C ions are switched on by lower doses and the chromosome damage repair proceeds more efficiently compared to γ rays.

The chromosome damage induced by low doses of ^{60}Co γ irradiation in human peripheral blood lymphocytes has been studied using different cytogenetic assays. Isolated lymphocytes were exposed to doses of 0.01–1.0 Gy, stimulated by PHA, and analyzed for chromosome aberrations within 48 h after irradiation by metaphase method, within 49 h — by anaphase method, within 58 h by micronucleus assay with cytochalasin B and, additionally, micronuclei were counted within 48 h on the slides prepared for metaphase analysis without cytochalasin B. Despite quantitative differences in the amount of chromosome damage revealed by different methods, all of them have demonstrated complex nonlinear dose dependence of the frequency of aberrant cells. In the dose range 0.01–0.05 Gy the cells have shown the highest radiosensitivity; at 0.05–0.5 Gy the dose-independent induction of chromosome damage has been revealed. At doses of 0.5–1.0 Gy the dose-effect curves have become linear with the decreased slope compared to the initial one (by a factor of 5 to 10 for different criteria), reflecting higher radioresistance of cells.

These data confirm the idea that the direct linear extrapolation of high-dose effects to low-dose range — the procedure routinely used to estimate genetic risk of low-dose irradiation — is incorrect and leads to underestimation of chromosome damage produced by low radiation doses. Similarly, the biodosimetry at doses below 0.5 Gy is not reliable (available).

At GSI (Gesellschaft für Schwerionenforschung), Darmstadt, Germany, in collaboration with Biophysics Group, the investigation of cellular response to radiation of different quality of normal healthy human tissue cells has been performed. The confluent cultures of normal human skin fibroblasts AG01522 have been used to examine the time-course of the chromosomal damage and proliferation behaviour. Nowadays this cell system is commonly used in predictive assays and radiation risk assessments based on the evaluation of chromosome damage. Cultured human fibroblasts are characterized by a limited number of cell divisions followed by terminal differentiation accompanied by the loss of proliferation capacity, senescence and death. This process of natural aging was shown to be accelerated by irradiation in the dose- and LET-dependent manner. As a first step of this process, the dose-dependent most likely permanent p53-mediated arrest state was shown to be induced in genetically damaged fibroblasts, which was regarded as a mechanism to maintain genetic integrity.

To further investigate the cellular response of normal human fibroblasts to radiation of different LET, confluent AG1522B cells were exposed to accelerated 200- and 16-MeV/nucleon carbon ions, 11-MeV/nucleon Ni ions (LET 16, 155 and 2455 keV/ μm , respectively) and X rays. The chromosome damage and cell cycle progression were examined at serial time points 4-h intervals from 20 to 70 h after postirradiation receding to low density so that essentially all dividing cells were sampled. Fluorescence-plus-Giemsa technique was applied to distinguish between metaphases of different postirradiation cell cycles.

A slight increase in the frequencies of aberrant cells and aberrations with sampling time has been found after the exposure of human fibroblasts to X rays and 200-MeV/nucleon C ions, while a more pronounced increase was detected after irradiation with 11-MeV/nucleon C and Ni ions, indicating the transient cell cycle delay of most heavily damaged cells. Moreover, for all kinds of radiation used the prominent dose-dependent decrease of mitotic activity was observed, reflecting drastic presumably permanent G_1 -arrest of irradiated human fibroblasts. Using mathematical analysis based on the integration of chromosome damage over the whole time of experiment, the fraction of cells that were able to proceed to the first postirradiation mitosis within this time interval has been estimated and found to be less than 10% of irradiated cells even after low doses of low LET radiation. With increasing dose and LET this effect became more pronounced. Hence, in all experiments only small fraction of human skin fibroblasts can be analyzed for radiation-induced chromosome damage by conventional cytogenetic techniques, in contrast to established cell lines. If the most heavily damaged cells

are preferentially arrested, the question about the representativeness of detected aberration yield with respect

to entire population arises. Further experiments are in progress to address this question.

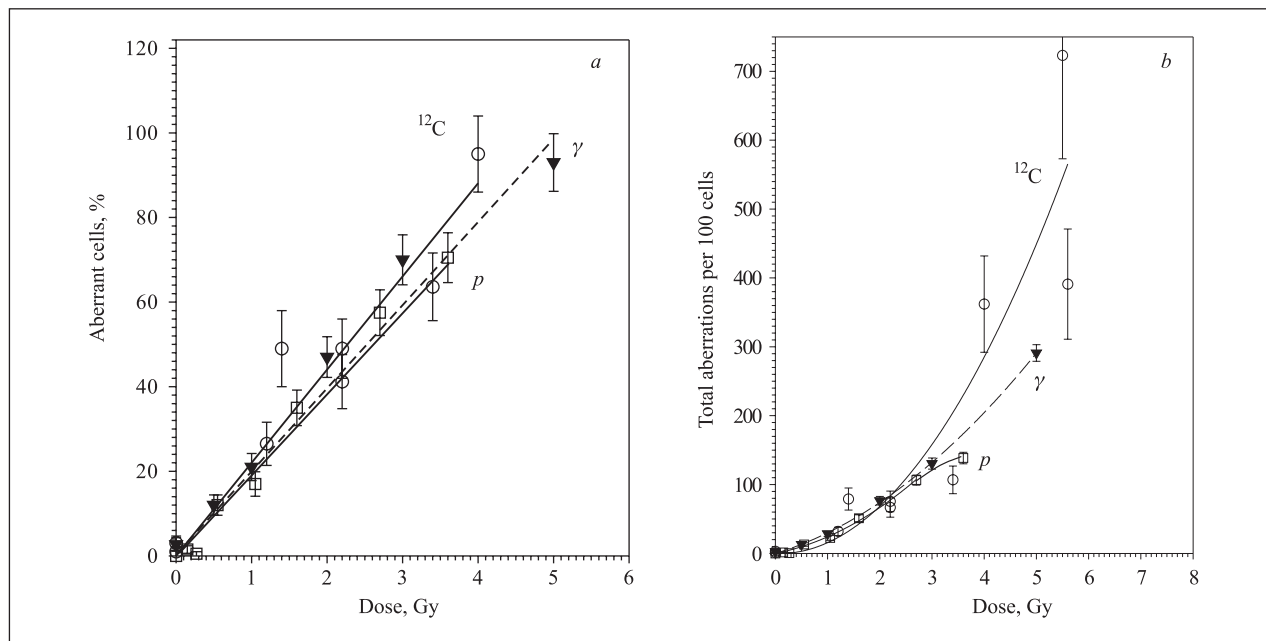

Dose-dependence of the frequency of aberrant cells (a) and of total chromosomal aberrations (b) after irradiation with protons (p), carbon ions ^{12}C and ^{60}Co γ rays: \circ — ^{12}C , $E = 473$ MeV/nucleon; \square — protons, $E = 1$ GeV; \blacktriangledown — γ rays

The first experiments with mammalian and human cells were performed at the beams of high-energy ions, generated by the Nuclotron [7]. Obtained data are shown on the figure for damage action of ^{12}C ions and the protons with an energy of 473 MeV/nucleon and 1 GeV, respectively, on human peripheral blood lymphocytes. There were shown no essential quantitative differences in the frequency of the cells with chromosomal damages, although the LET value of ^{12}C ions was more than 10 times higher than LET of the protons (10.65 and 0.218 keV/ μm , respectively). The cytogenetical effects of both particles were also similar to those of γ rays.

The investigations of the effective radiopharmaceuticals for diagnostics and target therapy with the help of radiolabeled methylene blue (MTB) were continued [8]. The experiments with MTB labeled with ^{131}I or ^{211}At in vitro and in vivo are performed. The earlier obtained results on high accumulation of the compound in melanoma as compared with the normal tissues (4–5 times higher) were confirmed. The maximum of accumulation is reached within 2 h after compound injection.

The study of mutation induction of different nature by ionizing radiation using yeast *Saccharomyces cerevisiae* as model system of eucaryotic cells was continued. Mutagenic property of ionizing radiation was char-

acterized by using four different mutator assays. They were a forward mutation rate assay that detects mutations inactivating the arginine permease gene (Can^r mutations) and reversion assays detecting mutations that revert a 4-base insertion in the LYS2 gene or that revert a +1T insertion in a stretch of 6 T's in the HOM3 gene. The reversion to Lys^+ and Hom^+ is due to deletion of a single nucleotide predominantly. Induction of base-pair substitutions by γ ray was studied earlier using special tester CYC1 -system. Induction of AT-TA transversion in diploid yeast cells by ^4He ions was tested. The shape dose curve is not linear for dose 100–1000 Gy. Efficiency of ^4He ions with $\text{LET} = 80$ keV/ μm for induction of transversions is less than efficiencies of ^4He ions with $\text{LET} = 20$ keV/ μm and γ ray.

The study of genetic control of DNA damage-induced arrest of cell cycle progression, named checkpoint control, was continued [9]. We intend to study interactions between the known checkpoint genes RAD9 , RAD24 , RAD53 and genes $\text{SRM5}/\text{CDC28}$, SRM8 , SRM12 using such a property as radiosensitivity. We determined that CDC28 and RAD53 genes define two epistasis groups. So, CDC28 and RAD53 define two branches of the pathway controlling radiosensitivity. Interactions between these two branches and RAD52 -repair pathway are under study.

The consequences of transposon Tn10 precise excision in *Escherichia coli* induced by heavy ions with different LET were studied [10–12]. Survival curves were obtained to define radiosensitivity of the cells after accelerated helium ion irradiation with LET from 20 to 100 keV/ μm , and accelerated carbon ion irradiation with LET of 200 keV/ μm . The dependence of the relative biological effectiveness (RBE) on LET was built. RBE maximum by the lethal action criterion was found after accelerated He ions irradiation with LET

of 100 keV/ μm . From the calculation of reversions in the *E. coli* gene *cysC95::Tn10*, the relative frequency of the precise excision as the function of the different heavy-ion irradiation doses was found, and RGE as the function of LET was obtained. Maximum of this RGE function was found on the interval from 20 to 50 keV/ μm . This fact allows the conclusion that the initiation of the induced precise excision starts from the cluster DNA breaks, as also does induction of the gene mutations.

RADIATION PROTECTION

The radiation monitoring for occupational exposure at JINR nuclear facilities was carried out by the automatic systems of radiation control (ASRC) and by portable instruments. The ASRC at VBLHE, FLNR and DLNP were improved in 2002.

The experiment on irradiation of ^{252}Cf target by ^{48}Ca ions was performed in 2002 at an FLNR facility. Taking into account the high radioactivity and toxicity of the target, special steps for the radiation protection were taken. This experiment is unique for FLNR and for JINR as a whole by reason of complexity of radiation environment. The run lasted 2900 h and there was no radiation incident.

Two runs on irradiation of tritium target were conducted at the DLNP phasotron in 2002. The radiation protection and control at the experiment were realized by the DRRR and VNIIEF specialists.

The investigation of radiation environment at the Nuclotron proton beam with a current of about $2 \cdot 10^{10}$ protons per cycle showed a lack of radiation

shielding in one of the experiments. As a result, the design and creation of the improved shielding near the F3 focus are planned.

In 2002 the individual dosimetry service maintained dose control to 1741 persons, including 57 visitors. The average individual yearly dose at JINR was 1.4 mSv. The maximum individual yearly dose was at FLNP (1.9 mSv).

The regular environmental monitoring of soil, plants and water from the river basins in the Dubna vicinity confirmed the conclusion that the environmental radiation pollution around JINR has remained constant for a long time and is due to natural radioactivity and products of global fallout only. Any contribution to radioactivity pollution of the environment from JINR nuclear facilities was not found. The exceeding of planned personal doses at JINR was not observed in 2002. The level of radiation protection and control at JINR corresponded to the federal rules and regularities, which was confirmed the regular inspections.

EDUCATIONAL ACTIVITY

The educational process on the specialty «Radiation Protection of People and Environment» at the chair «Biophysics» of the International University «Dubna» was continued. Ten new students were admitted in 2002. The new specialty «Biophysics of Photobiological Processes» will be established at the chair in 2003 by the initiative of Academician M. A. Ostrovsky. This specialty proposes in-depth study of the physicochemical and molecular-biological methods, the fundamentals of photophysics and photochemistry, the knowledge of laser technique, the kinetics of the initial photobiological processes in femto- and nanosecond time ranges. The specialists in this field are necessary both for research centres and for various scopes of prac-

tical activity: medicine (ophthalmology, dermatology, photochemotherapy), pharmacology, phototoxicology, biotechnology, microelectronics and others.

REFERENCES

1. *Bamblevski V. P. et al.* JINR Preprint E3-2002-273. Dubna, 2002.
2. *Hashemi-Nezhad S. R. et al.* // Nucl. Instr. Meth. A. 2002. V.482. P. 537; 547.

3. *Boreiko V. F. et al. // Ibid. V. 490. P. 344.*
4. *Bystritsky V. M. et al. // JINR Preprint D15-2002-200. Dubna, 2002.*
5. *Shmakova N. L. et al. // Rad. Biol. Radioecology. 2002. V. 42, No. 3. P. 245.*
6. *Shmakova N. L. et al. // Problems of Biochemistry, Radiation and Space Biology: II Intern. Symp. and II Sissakian Readings. Dubna, 2002. V. 1. P. 188.*
7. *Govorun R. D. et al. // Adv. Space Res. 2002. V. 30, No. 4. P. 885.*
8. *Shmakova N. L. et al. // Med. Radiology & Rad. Safety. 2002. V. 47, No. 3. P. 5.*
9. *Koltovaya N. A., Devin A. B. // Dokl. Akad. Nauk. 2002. V. 387, No. 6. P. 1.*
10. *Zhuravel D. V. // Vestnik Univ. «Dubna». 2002. P. 50.*
11. *Zhuravel D. V., Boreiko A. V. // Rad. Biology. Radioecology. 2002. V. 42, No. 6. P. 635.*
12. *Boreiko A. V., Zhuravel D. V. // Problems of Biochemistry, Radiation and Space Biology: II Intern. Symp. and II Sissakian Readings. Dubna, 2002. V. 1. P. 125.*

UNIVERSITY CENTRE

In 2002, the JINR University Centre (the UC) continued its work within the framework of the first-priority topic «Organization, Maintenance, and Development of the University-Type Educational Process at JINR».

In 2002, a seven-year programme of JINR's educational activity development was prepared. It is founded upon the concept of continuous education. One of the areas of the work towards training skilled young specialists is attracting secondary school students to the studies on the basis of a special school laboratory practicum.

At the UC, graduate students complete their higher education. In 2002, the UC's total enrolment was 215 students from higher education institutions of JINR Member States. The students' curricula have been worked out jointly with their home institutions. Table 1 shows the distribution of the UC students over the home institutions.

Table 1

| Institution | Number of students at the UC in 2002 |
|---|--------------------------------------|
| Moscow State University | 17 |
| Moscow Engineering Physics Institute | 17 |
| Moscow Institute of Physics and Technology | 38 |
| Institutions of other JINR Member States (Armenia, Belarus, the Czech Republic, Georgia, Russia, Slovakia, and Ukraine) | 44 |
| Total: | 116 |

Besides, 99 students of Moscow Institute of Radio Engineering, Electronics, and Automatics attend the UC's courses.

An important aspect of the Educational Programme development consists in extending the range of specialties and departments on the basis of the UC's existing ties with higher education institutions of the Russian

Federation and attracting new partners to this activity. In 2002, a branch of the Department of General Physics and Thermonuclear Fusion of Moscow Power Engineering Institute was established at the UC.

In 2002, 30 JINR staff members lectured at the UC. 180 students of Dubna University had practice and performed their bachelor's, master's, and diploma theses at JINR.

The UC works out its own programmes for separate student groups. In January, 2002, the Slovak students who attended the UC's special programme within the framework of training specialists for the Slovak Cyclotron Complex, which is being built with the help of JINR, successfully defended their diploma theses. The theses were performed at the Laboratory of Nuclear Reactions. The following theses were defended:

- Miloslav Rajcan, «Modelling Ion Loss on the Residual Gas for Determining the Basic Parameters of the Vacuum System of the Beams Transportation at the DC-72 Cyclotron», under scientific supervision by A. V. Tikhomirov;
- Matus Mozolik, «Basic Concepts of a Cyclotron for Applied Research», under scientific supervision by G. G. Giulbekian;
- Andrej Skotta, «Experimental Study of the Multiply Charged Ion Injector with the ECR Source», under scientific supervision by S. L. Bogomolov.

A group of Polish students that visited the UC in February, 2002, within the Bogoliubov–Infeld programme, attended lecture courses on information technologies. The courses were specially prepared for the group; they included introductions to databases, UNIX operating system, telecommunications, and the GRID system.

Besides the regular lectures, the UC offered the following courses to its students and postgraduates, as well as to all persons interested:

- Yu. A. Alexandrov, «Particle Physics and Low-Energy Neutron Physics»;

- E. G. Nikonov, «Object-Oriented Programming in C++»;
- A. I. Sidorov, «Pulsed Equipment»;
- A. A. Smolnikov, «Neutrino Physics at Non-Accelerator Facilities»;
- D. Yu. Bardin, «Introduction to CalcPHEP»;
- Yu. V. Zanevsky, «Two-Dimensional X-Ray Detector for Medical and Biological Research»;
- Yu. E. Penionzhkevich, «Experimental Methods in Nuclear Physics»;
- T. F. Solovyova, «Object-Oriented Analysis as Exemplified by the ROOT Package»;
- Yu. A. Plis, «Magnetic Resonance Tomography Using Hyper-Polarized Noble Gases Helium-3 and Xenon-129»;
- G. A. Karamysheva, «Medical Accelerator»;
- M. Z. Ruzayeva, «Industrial Organization and Planning».

In 2002, the following lecture courses were given as part of the lecture cycle «Modern Problems of Natural Sciences»:

- Prof. Yu. V. Gaponov (Kurchatov Institute, Moscow), «Problems of the Physics of Low-Energy Weak Interaction»;
- Prof. Gerard Smadja (Lyon I University, France), «Geometry of the Expansion of the Universe. Friedmann's Equation and Measurements with Supernovae»;
- Prof. V. N. Pervushin (JINR), «New Astrophysical Data and Unified Field Theory»;
- Prof. V. N. Pervushin (JINR), «Hamilton's Cosmology of the Early Universe».

The list of the UC's publications for its students and postgraduates was extended to include the following textbooks:

- S. A. Gritsenko, V. V. Krasilnikov, and E. A. Kurayev. «Equations of Mathematical Physics. Part I» — YHII-2002-14;
- Yu. V. Zanevsky, L. P. Smykov, G. A. Chereymukhina, and S. P. Chernenko. «Two-Coordinate Soft X-Ray Detector» — YHII-2002-15.

In 2002, JINR continued its postgraduate programmes in ten specialties in physics and mathematics. The 2002 total postgraduate enrolment was 62, whose distribution over the JINR Laboratories is represented by Table 2.

During the functioning of the JINR postgraduate programmes, 17 of those who had completed them defended their candidate's theses.

The UC postgraduates actively participate in research. They present their work at seminars and conferences held at JINR and other scientific institutes of Russia and other Member States. More detailed information is available at the UC's Internet site (<http://uc.jinr.ru>).

In 2002, the UC actively developed its traditional ties with foreign institutions of higher education. The Leonard Euler Programme of the German Service of Academic Exchanges (DAAD) supported for 2000–

2001 and continued for 2002–2003 a joint project by the UC and the Institute of Theoretical Physics of Giessen University (Germany). Within this project, postgraduates and students together with scientists of the UC and Laboratory of Theoretical Physics carry out theoretical research in heavy ion physics and are paid additional stipend. They presented the research results as two reports to the Symposium on Nuclear Clusters: From Light Exotic to Superheavy Nuclei (Rauischholzhausen, near Marburg, Germany; August, 2002) [1–5].

Table 2

| JINR's Laboratories and subdivisions | Number of postgraduates in 2002 |
|--|---------------------------------|
| Laboratory of Theoretical Physics | 13 |
| Laboratory of Nuclear Problems | 10 |
| Laboratory of Particle Physics | 9 |
| Laboratory of Information Technologies | 8 |
| Laboratory of High Energies | 7 |
| Laboratory of Neutron Physics | 7 |
| Laboratory of Nuclear Reactions | 5 |
| University Centre | 2 |
| Division of Radiation and Radiobiological Research | 1 |
| Total: | 62 |

Within the Educational Programme, a group of Romanian students of the Universities of Bucharest, Cluj-Napoca, Craiova, Iasi, and Timisoara had their practice at the Institute in August, 2002. They were acquainted with JINR's basic facilities and participated in research that is actually performed at the Institute's Laboratories. Altogether, 20 Romanian students visited JINR in 2002, which became possible thanks to a grant from Romania's Plenipotentiary to JINR.

In October, 2002, a delegation from the UC, jointly with students and postgraduates of the Adam Mickiewicz University (Poznan, Poland) and Czech Technical University (Prague, the Czech Republic), toured a number of research centres and universities of Poland and the Czech Republic.

During 2002, to exercise a specialized practicum, get consultations, and work with scientific supervisors, eight student and two secondary school student groups, and 11 postgraduates — altogether 115 people — visited the UC within the framework of the educational part of the Bogoliubov–Infeld programme. The students came from Gdansk, Katowice, Krakow, Lodz, Poznan, Szczecin, and Warsaw.

Supported by a grant from the Czech Republic's Plenipotentiary to JINR, 23 students from the Czech Republic visited JINR in July, 2002. They have been to the UC and the Institute's Laboratories, where they have been acquainted with the fields of the Institute's research.

In 2002, the UC continued industrial engineering education, retraining, and improvement of the qualifi-

cations of JINR's technical and working staff members. The UC coordinated the education process on the basis of JINR's Laboratories and subdivisions.

Seven newly accepted JINR staff members got their allied specialties; four JINR staff members were trained

in new specialties. At the courses of training the staff for the installations supervised by the Federal Technical Inspection, 110 JINR staff members and 19 employees of organizations located in Dubna were trained and certified. Table 3 shows major details of this activity.

Table 3

| Kind of training | Capacity of the trained staff |
|---|--|
| Training and certification at the Russian Centre of Chlorine Safety | JINR's seven authorities and specialists |
| Improvement of qualifications at Moscow Institute of Improving the Qualifications of Authorities and Specialists of the Ministry of Atomic Industry of the Russian Federation | Two JINR staff members |
| Training and certification in maintaining and operating machinery, mechanisms, and equipment | 41 JINR staff members |
| Improvement of qualifications at the seminars offered by the education institutions of Dubna, Moscow, and St. Petersburg | 30 JINR staff members |

In 2002, 20 students of Technical Schools No. 67 and No. 95 (Dubna) had practical training at JINR.

A branch of the preparatory courses training entrants to Moscow Engineering Physics Institute (MEPI) has been opened on the basis of the UC. In the academic year 2002–2003, the enrolment is 18 students of Dubna's secondary schools. Fifteen of those who completed the previous academic year's courses have been admitted to the following higher education institutions: Moscow State University; MEPI; Moscow Aviation Institute; Moscow Institute of Radio Engineering, Electronics, and Automatics; and Dubna University.

A special laboratory has been created at the UC for the demonstration of experiments in physics to secondary school students. The laboratory is being equipped: The Mechanics I, Mechanics II, and Optics installations have already been received from Moscow Institute of Physics and Technology. The demonstrations include experiments showing the surface tension of liquids («floating sieve», interaction between glass plates, etc.); stroboscopic view of the water-jet structure; full reflection (the «black ball» experiment); charged liquid rotation in the magnetic field; vacuum-related phenomena (display of the atmospheric pressure force, cold water boiling under the air pump hood, etc.); and buoyancy loss (the «anti-Archimedes installation»).

Demonstrations like these, especially uncommon ones, can rouse amazement and, as a consequence, give rise to the will to study a specific phenomenon. Seeing such experiments requires understanding the nature of the phenomenon and determining the main factor among the many. The experiments «with much kick» develop the physics-based thinking of secondary school and higher education students, broaden the horizons of their knowledge, and lay the foundations of their scientific outlook. In prospect, the practicum for secondary

school students is going to be extended. It is also planned to show these experiments to the city's teachers of physics.

The UC's activities have been supported within the programme «Integration», which develops the close interaction between the education process and actual research carried out by JINR's teams. In 2001, the UC got a grant from this programme for conducting the international summer student school «Nuclear Methods and Accelerators in Biology and Medicine», and in 2002, the joint application of the UC, Laboratory of Nuclear Problems (JINR), Moscow Engineering Physics Institute, and Moscow Institute of Physics and Technology was approved, which is aimed at creating a collective use centre — a laboratory practicum in medical physics.

Attaching great importance to the development of international student exchanges, the UC participates in the organization and conduction of international student schools.

On June 19–30, 2003, the international student school «Nuclear Physics Methods and Accelerators in Biology and Medicine» will be conducted in Poznan, Poland, as part of the cycle of JINR's summer student schools. On September 7–18, 2003, the Second Summer Student School on Neutrino Physics in Memory of Bruno Pontecorvo will be held in Alushta, Ukraine.

In 2002, the proceedings of the international summer student school «Nuclear Methods and Accelerators in Biology and Medicine», which took place in Dubna on June 27 – July 11, 2001, were published. The book includes lectures by scientists and reports by participant students.

The success of JINR's experience of creating and developing the Educational Programme is confirmed by a notable decrease in the average age of the physicists of the Institute's research teams. This experience was

positively appraised, in particular, by a resolution of the Bureau of the Nuclear Physics Section of the Russian Academy of Sciences (September 25, 2001).

The UC's Internet site (<http://uc.jinr.ru>) is regularly updated.

REFERENCES

1. Zubov A. S., Ivanova S. P. *et al.* Survival probability of superheavy nuclei // Phys. Rev. C. 2002. V. 65. P. 024308.
2. Zubov A. S., Ivanova S. P. *et al.* Survival probability of excited superheavy nuclei // Phys. At. Nucl. 2002 (in press).
3. Zubov A. S., Ivanova S. P. *et al.* Survival probability of excited heavy and superheavy nuclei // Heavy Ion Phys. 2002 (in press).
4. Zubov A. S., Ivanova S. P. *et al.* Survival probability of excited heavy nuclei // Acta Phys. Pol. B. 2002 (in press).
5. Zubov A. S., Ivanova S. P. *et al.* Competition between different evaporation channels in neutron-deficient nuclei // Phys. Rev. C. 2002 (submitted).



Dubna, 24 January. Workshop «New Model and Nuclear Physics Methods in Biophysics and Biochemistry». Academician D. Shirkov is speaking



Dubna, 21 July – 10 August. DAAD school «Quantum Statistics of Many-Particle Systems»

Dubna, 11 July. Participants of the International Workshop on Quantum Gravity and Superstrings





Dubna, 26 April.
Veksler and Baldin Laboratory
of High Energies.
A seminar dedicated
to the 45th date of the
Synchrophasotron launching

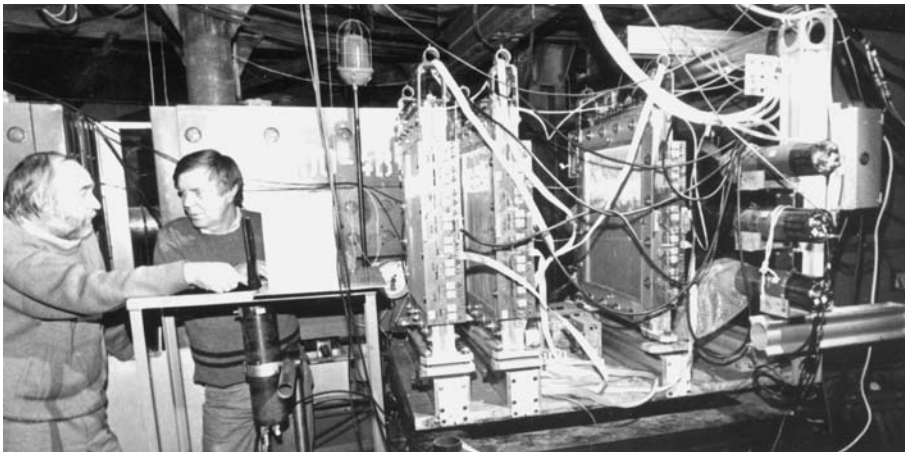

Veksler and Baldin
Laboratory of High Energies.
The ALPOM set-up.
Measurements of the polarization
of a deuteron beam accelerated
at the Nuclotron



Veksler and Baldin
Laboratory of High Energies.
The polarized deuterons' source
POLARIS



Dubna, 6 August. Director of the Dzhelepov Laboratory of Nuclear Problems N. Russakovich talks to guests from CERN about the status of joint efforts at LHC

Dzhelepov Laboratory
of Nuclear Problems.
JINR Chief Engineer
Professor I. Meshkov
acquaints Professor N. Rowley,
Chairperson of the Programme Advisory
Committee for Nuclear Physics,
with the work on the LEPTA project



Geneva (Switzerland), July. JINR Directorate representatives and spokespersons from JINR and CERN at the presentation of module 65 for the hadron calorimeter at ATLAS





Dubna, 17–19 June. Workshop on Investigations at the IBR-2 Reactor.
Professor V. Aksenov congratulates the winners in the competition of papers among young scientists, postgraduates and students

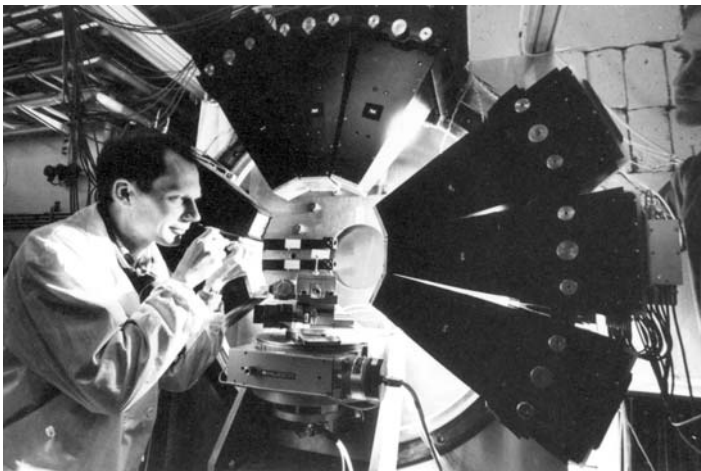

Frank Laboratory of Neutron Physics.
The diffractometer SKAT for research into the texture and internal stresses in materials

Dubna, 22 May. Participants of the X International Seminar on Interaction of Neutrons with Nuclei (ISINN-10)





Dubna, 26 May. International School-Seminar on Heavy Ion Physics

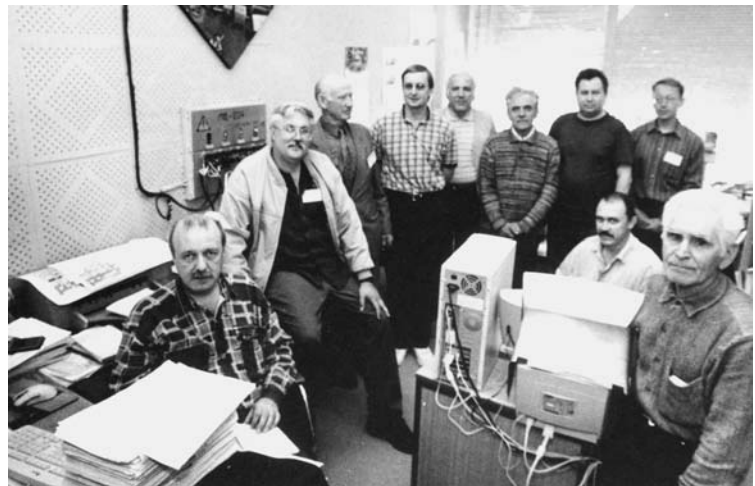

Flerov Laboratory of Nuclear Reactions.
A group of participants of the experiment
on element 118 synthesis

Flerov Laboratory of Nuclear Reactions. The experiments on the synthesis of element 118 are conducted at the U400 cyclotron by using a unique target of ^{249}Cf produced by JINR specialists and researchers from SRIAR (Dimitrovgrad, Russia)

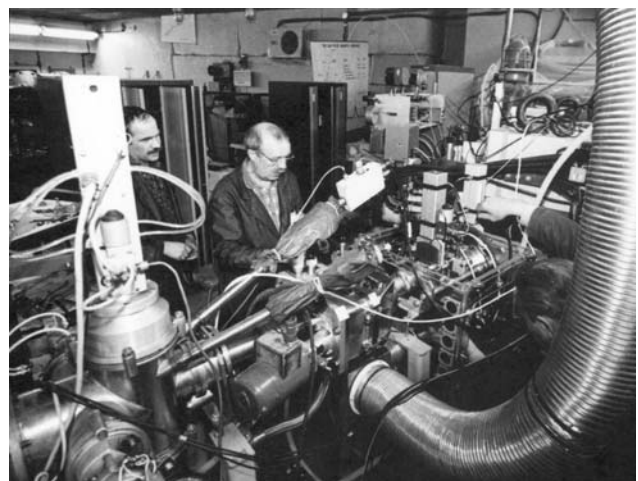



Laboratory of Particle Physics.
Stand-by tests of the damping system
for transverse oscillations of a particle
beam at CERN's LHC



Laboratory of Particle Physics.
A test site for proportional chambers
for the CMS end-cap spectrometer

Laboratory of Particle Physics, 20 December.
A display of computer communication in the mode of the teleconference JINR-BNL (USA)





Dubna, 30 September. The V International Congress on Mathematical Modelling

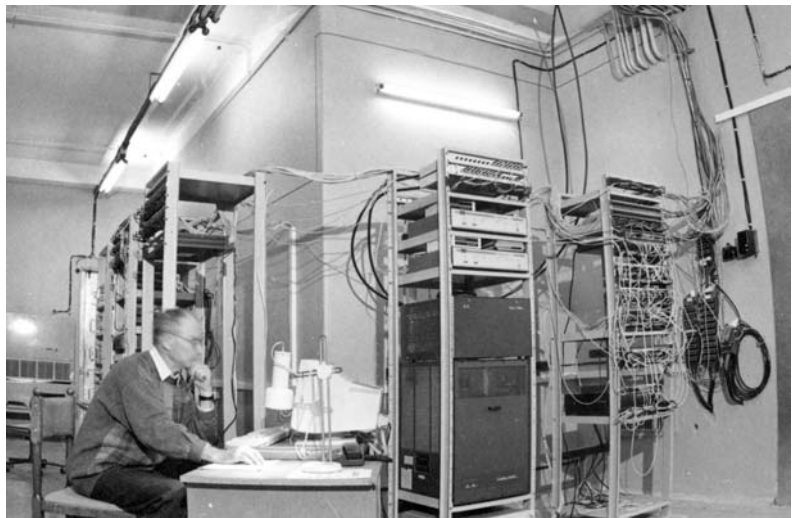

Laboratory of Information Technologies.
The centre of JINR computer net

Laboratory of Information Technologies. A complex of PC clusters, consisting of an interactive cluster and computer farm of general purpose, a computer farm for the LHC (CMS, ATLAS, ALICE) experiments and a cluster for parallel counting on the basis of MYRINET technique





Dubna, April.
A group of Polish students
on an excursion at the Frank Laboratory
of Neutron Physics



University Centre.
Romanian students visit UC Director
S. Ivanova (right)

University Centre. Defence of master's theses by sixth-year students of the
Moscow Institute of Physics and Technology



Experimental Workshop.
Discussion of the activities on the
development of the equipment for research
of space rays with maximum
possible high energy



Experimental Workshop.
Electrophysical equipment
produced for the Cyclotron Centre
in Bratislava (Slovakia)



Experimental Workshop. Control assembling
of the new movable reflector MR-3
for the IBR-2 reactor



Savelovo (Russia), December. The ALICE dipole magnet core produced
at the engineering works for the joint JINR-CERN project

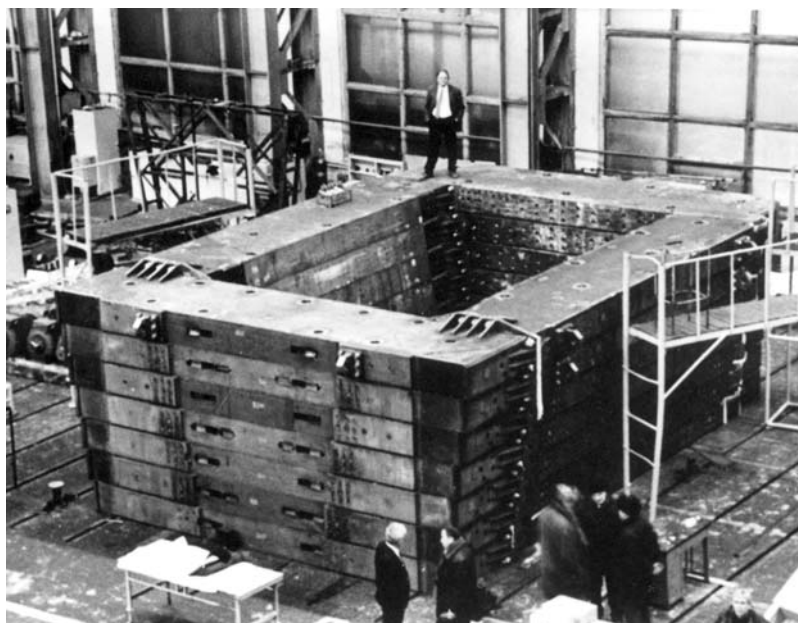

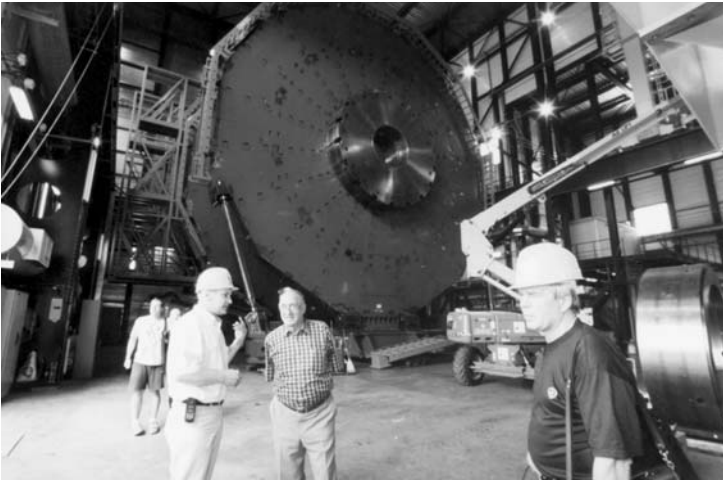

Geneva (Switzerland), July.
Traditional CERN-JINR cooperation
is in progress

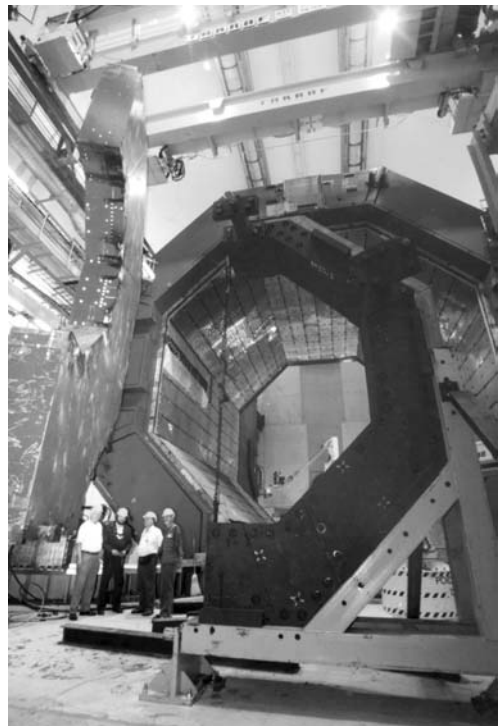

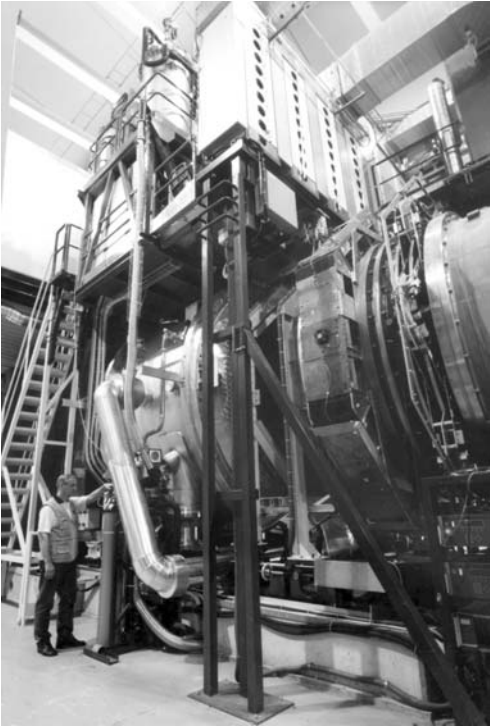

*«We at CERN value highly the key role played by Dubna in the attraction of experts and resources, and in uniting the efforts of its member states to implement most important tasks at LHC»
(L. Maiani)*

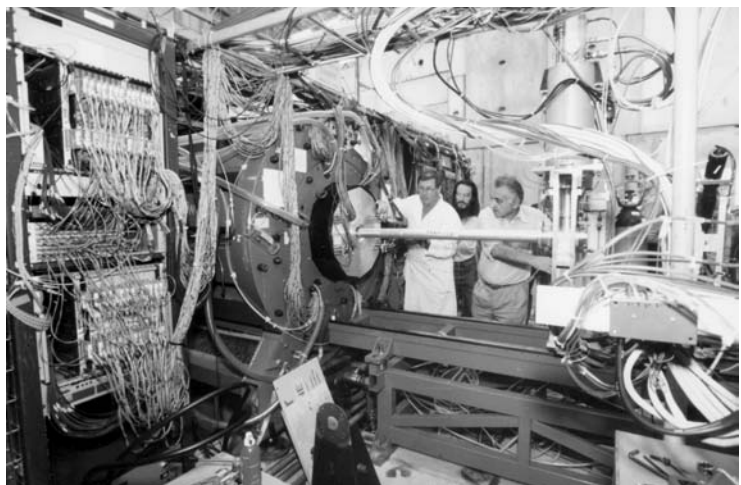
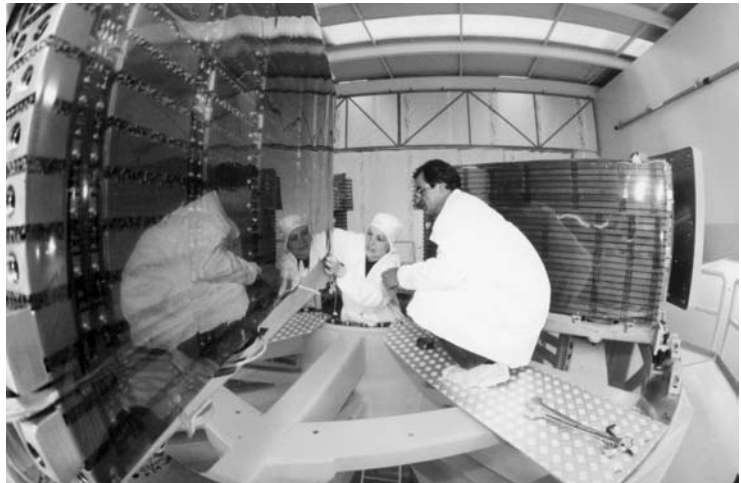



Dubna, 3 June. Science Adviser to the US President Dr J. Marburger visited JINR. The American delegation is received at the Flerov Laboratory of Nuclear Reactions



Dubna, 27 June. Visit of a Chinese delegation headed by Academician Chou Guanchao to JINR. A warm meeting with colleagues at the Bogoliubov Laboratory of Theoretical Physics



Dubna, 27 March. The visit of a delegation of Czech Parliament Members to JINR. Excursion to the Nuclotron

CENTRAL SERVICES



PUBLISHING DEPARTMENT

In 2002 the Publishing Department published JINR communications and preprints of 298 titles. Issued were 116 official publications.

A total of 46 proceedings of various conferences, schools and workshops organized by JINR were issued. Among them are proceedings of the international symposium «Problems of Biochemistry, Radiation and Space Medicine» and II Sissakian Readings (in two volumes), the international workshop «Relativistic Nuclear Physics: from Hundreds of MeV to TeV» (in two volumes), the IV Scientific Seminar in Memory of V.P. Sarantsev, the VI workshop «Nucleation Theory and Its Application», the II German–Russian Workshop of the IBR-2 Reactor Users, the XVI symposium «Supersymmetries and Quantum Symmetries», the fourth all-Russian scientific conference «Digital Libraries: Advanced Methods and Technologies, Digital Collections» (in two volumes). Also published were the annual reports of JINR for 2001 (in Russian and in English), the annual report of the Frank Laboratory of Neutron Physics for 2001. The proceedings of the round-table discussion held during the 91st session of the JINR Scientific Council in January, 2002, are included into a collection «Cooperation of JINR with Institutions, Universities and Enterprises of Belarus».

A book «Yurii Mechislavovich Ostanevich. Scientist. Teacher. Friend (to the 65th birthday anniversary)» is dedicated to the life and scientific activity of the noted experimental physicist. The book includes reminiscences about Yu. M. Ostanevich of staff members of the Frank Laboratory of Neutron Physics, where the scientist worked from 1959 till 1992, as well as of his colleagues and friends from many scientific centres of the world.

An anthology «Lyric Physics», compiled by T. Bek, includes poems written by JINR staff members at different times.

A collection of poems «Waiting for a Wonder» by A. N. Sissakian, compiled by the author from poems written in 1999–2002, was published.

In 2002, seven issues of the journal «Physics of Elementary Particles and Atomic Nucleus» with 56 articles

were printed. The additional issue, No. 7, includes the proceedings of the IX international conference «Symmetry Methods in Physics». Also published were six issues of the journal «Particles and Nuclei, Letters» with 54 articles, describing original scientific, technological, methodical and applied results. Publication of the bulletin «JINR News» in the Russian and English languages was continued.

Five textbooks of the JINR University Centre were published. Among them are: V. V. Papoyan «Selected Lectures on Classical Electrodynamics»; V. V. Papoyan «Classical Mechanics. Lectures, Tasks and Solutions»; Yu. V. Zanevsky, L. P. Smykov, G. A. Cheremukhina, S. P. Chernenko «Two-Dimensional X-Ray Detector»; N. V. Antonenko, S. P. Ivanova, A. S. Zubov, O. V. Fotina «Statistic Approach to the Nuclear Reaction Analysis Using the GROGIF Program».

The Publishing Department sent more than 300 articles and reports by JINR scientists to journals and various conferences, symposia, workshops, schools, held both in the JINR Member States and in other countries. Papers by JINR staff members were published in the «Journal of Experimental and Theoretical Physics», «Instruments and Experimental Techniques», «Yadernaya Fizika», «Physics of Elementary Particles and Atomic Nucleus», «Physical Review», «Journal of Physics», «Physics Letters», «Nuclear Physics», «Nuclear Instruments and Methods», «European Physical Journal», etc.

Publications of the Joint Institute for Nuclear Research were sent to 44 countries of the world.

To keep readers of the Science and Technology Library up to date as to new publications received, there are bulletins of the Library and of the Intellectual Property, Licensing and Standardization Office printed by the Publishing Department. Traditionally, the «Bibliographic Index of Papers Published by JINR Staff Members in 2001» was issued.

The Publishing Department was also engaged in Xerox copying and book binding to fulfil numerous orders of JINR Laboratories. Over 130,000 various forms were printed for processing of experimental information and for other purposes.

SCIENCE AND TECHNOLOGY LIBRARY

In 2002, the Science and Technology Library rendered services to 4,754 readers. 318,000 copies of books were given out. 838 publications ordered by readers were received via the interlibrary exchange system.

The Library received 7,856 books, periodicals and preprints from all compiling sources, including 4,925 publications in foreign languages. All new publications were registered in the central catalogues and branch catalogues. By 1 January 2003, the library stock amounted to 433,479 copies, 194,186 of them in foreign languages.

Weekly express bulletins «Books», «Articles», «Preprints» (156 issues) were published with data on 16,905 titles. The bulletins were distributed among 200 JINR staff members and mailed to 50 addresses outside the Institute. Starting from December, 2002, the subscription of electronic versions of weekly information bulletins can be made via e-mail. Subscription is available on the STL site.

The «Bibliographic Index of Papers Published by JINR Staff Members in 2001» (1,480 titles) was published by the JINR Publishing Department. The database on papers by JINR scientists (bibliographic descriptions of papers since 1987) is Internet accessible.

In 2002, in exchange for JINR publications printed by the JINR Publishing Department, the library received 3,841 publications from 29 countries. Among them 455 issues were from Russia, 589 from Germany, 201 from Italy, 1,012 from the USA, 99 from France, 39 from Switzerland, 749 from Japan, and 386 from CERN.

In 2002 in the framework of the information system LIBER the following was done:

- a database for 1,631 readers is created;
- as of 16 December 2002 the input of documents to the electronic catalogue was:
 - books — 5,797 records,
 - journals — 3,257 records,
 - preprints — 2,747 records,
 - theses and author's abstracts — 578 records.

INTELLECTUAL PROPERTY, LICENSING AND STANDARDIZATION OFFICE

In 2002 the activities of the Office were conducted in several areas.

Licensing. Licenses were produced for the following departments and Laboratories:

- for the Department of Energy Supplies to acquire water;
- for FLNP to install uranium targets;
- for the University Centre to provide postgraduation procedure.

Participation in insurance licensing:

- third-person responsibility while transporting radioactive substances (Num. 1, dated 28 June 2002);
- civil responsibility of the organization which uses dangerous industrial sites (Num. 50, dated 11 August 2002).

A report has been worked out on licensing at STC for chief engineers.

An Order and a Norm document have been issued on the organizational activities in obtaining license for separate types of activities at JINR in accordance with the JINR Charter. In line with the produced license registry, acting licenses were controlled, the registry was corrected and compiled.

Patents and Information. In 2002, 72 official patent bulletins of the Russian Federation were acquired, the Office stock was 1876 bulletins. Their publication was processed with accounting for JINR

research topics. Twelve issues of the «Patents» bulletin were produced for departments.

Intellectual Property Protection. In 2002, three applications for invention were produced and delivered to the RF Patent Department. These were:

- «Method of Obtaining Asymmetric Track Membrane» (FLNR);
- «Method of Obtaining Selenium-Containing Medicaments Based on *Spirulina* Biomass» (FLNP);
- «Generator of Tagged Neutrons»(LPP).

Two positive decisions for applications handed earlier and 2 patents (FLNR) were received.

Nine applications for invention are at the RF Patent Department for consideration.

Standardization. Collections on the GOST and TU information were revised in accordance with the acting GOST values. Changes 2 and 3 to TU 4601-96 were issued.

Main documents which are included into the «Index of Main Legislative Acts and Norm Documents» used by JINR in the activities in the field of atomic energy usage were compiled, in line with Order 510, dated 20 September 2002.

Standard library was compiled (40 copies were purchased in the standard shop), 226 copies of standard index were delivered to departments for constant use.

Sixty-eight changes were inserted into GOST values.

EXPERIMENTAL WORKSHOP

In 2002, the JINR Experimental Workshop manufactured products to an amount of 14.6 million roubles on the orders of the JINR Laboratories and other departments. To fulfill these orders, the Workshop used more than 30 per cent of its power. Like in the previous year, mainly mechanical equipment was manufactured. The largest items were doublets of electromagnetic quadrupole lenses; parts of the flexible reflector for the IBR-2 reactor; high-pressure chambers for experiments at IBR-2; hadron and liquid argon modules of the ATLAS Hadron Calorimeter; MDT chambers' rigging.

Much work was done in the framework of international cooperation of JINR. The manufacturing of the

spectrometer for the Technical University of Munich (Germany) and the equipment for Wayne University (USA) was completed. Manufacturing and installation was started for the Barrel Toroid windings and two End-Cap Toroids at CERN (ATLAS).

The considerable amount of side orders was still obtained from the ASPECT Scientific Production Centre in the sphere of control of the radioactive materials transport and from the business centre «Magistr» with the equipment for baking. Among these orders were those from about 40 enterprises and organizations of different industrial profiles.

ADMINISTRATIVE ACTIVITIES



FINANCIAL ACTIVITIES

The Committee of Plenipotentiaries of the Governments of the JINR Member States approved a budget of US \$ 37,500.0 thousand to cover research, construction of basic facilities, and other JINR activities in 2002. The actual annual receipts amounted to US \$ 28,188.4

thousand, or 71.2 % of the annual allocations.

In 2002, the actual research expenditures of the Joint Institute for Nuclear Research amounted to US 26,798.4 thousand.

Actual expenditures were as follows:

| Item | Annual budget, US \$ thous. | Actual expenditures in 2002, US \$ thous. | % of budget |
|--|-----------------------------|---|-------------|
| I. Research | 14,434.4 | 12,757.3 | 88.4 |
| II. Basic facilities | 6,341.8 | 5,433.9 | 85.7 |
| III. Infrastructure of the Laboratories | 4,752.1 | 3,860.8 | 81.2 |
| IV. Infrastructure of the Institute | 5,278.9 | 4,746.4 | 89.9 |
| V. On agreement with BMBF less JINR infrastructure and Directorate reserve fund expenditures | 783.6 | | |
| VI. On agreement with the Hungarian Academy of Sciences less JINR infrastructure and Directorate reserve fund expenditures | 127.5 | | |
| VII. Plenipotentiaries' grants, 8 % of Member States' contributions | 2,914.2 | | |
| VIII. Directorate reserve fund, 5 % of budget | 1,867.5 | | |
| IX. Debt payment | 1,000.0 | | |
| Total expenditures | 37,500.0 | 26,798.4 | 71.5 |

STAFF

As of 1 January 2003, the total number of the staff members at the Joint Institute for Nuclear Research was 5,602 (without temporary staff).

Working at JINR are: full members of the Russian Academy of Sciences (RAS) — V. G. Kadyshevsky, D. V. Shirkov; corresponding members of RAS — I. N. Meshkov, Yu. Ts. Oganessian; full members of other academies of sciences — V. L. Aksenov, A. V. Eremin, I. A. Golutvin, V. I. Korogodin, A. A. Kuznetsov, V. A. Moskalenko, A. M. Petrosyants, A. G. Popeko, A. N. Sissakian; corresponding members of other academies of sciences — S. P. Ivanova, V. A. Khalkin, R. M. Mir-Kasimov, A. I. Titov, A. S. Vodopianov, B. N. Zakhariev, I. Zvara;

250 doctors of science, 645 candidates of science, including 90 professors and 15 assistant professors.

In 2002, there were 727 people employed and 636 people discharged because of engagement period expiry and for other reasons. During the year the JINR staff members were awarded the titles of senior researcher — 4, junior researcher — 4.

In 2002, 25 scientists received a Candidate of Science degree and 11 received a Doctor of Science degree at JINR, among them 22 from JINR, 1 from the Republic of Armenia, 1 from Bulgaria, 1 from Georgia, 1 from Egypt, 1 from Kazakhstan, 1 from Moldova, 1 from Mongolia, 6 from the Russian Federation, 1 from Slovakia.

AWARDS

The title «*Honoured Citizen of the Moscow Region*» was conferred on Vladimir Kadyshevsky, Director of the Joint Institute for Nuclear Research, in recognition of his long-standing dedicated scientific work.

The title «*Honorary Doctor of JINR*» was awarded to Professors V. Zinov (JINR), S. Korenchenko (JINR), Ch. Briançon (France), V. Khalkin (JINR), Academician B. Paton (Ukraine), Professors M. Likhachev (JINR), A. Smirnov (JINR), V. Penev (JINR), W. Greiner (Germany), for their outstanding contributions to the ad-

vancement of priority branches of science and technology, and education of young scientists.

For their meritorious services to JINR, long-standing and fruitful activities, 18 staff members were awarded the title «*Honorary Staff Member of JINR*», and 31 — «*Honorary Diplomas of JINR*».

295 JINR staff members were awarded a departmental badge «A Veteran of Atomic Energy Industry» in 2002.

Responsible for the preparation of the Annual Report: *B. M. Starchenko*

The Annual Report was prepared by

| | |
|-------------------------|----------------------------|
| <i>V. A. Bednyakov</i> | <i>E. B. Plekhanov</i> |
| <i>A. A. Belkov</i> | <i>A. G. Popeko</i> |
| <i>V. I. Danilov</i> | <i>V. V. Sikolenko</i> |
| <i>S. P. Ivanova</i> | <i>T. A. Strizh</i> |
| <i>T. N. Kharzheeva</i> | <i>G. N. Timoshenko</i> |
| <i>T. B. Kiseleva</i> | <i>L. A. Tyutyunnikova</i> |
| <i>L. G. Lukyanova</i> | <i>T. Ya. Zhabitskaya</i> |
| <i>A. E. Nazarenko</i> | <i>V. I. Zhuravlev</i> |

Translation by

M. V. Aristarkhova
S. V. Chubakova
T. F. Drozdova
O. K. Kronshtadtov
I. V. Kronshtadtova
M. I. Morozova
S. S. Negovellov
G. G. Sandukovskaya

Design by

Yu. G. Meshenkov

Photographs by

Yu. A. Tumanov
P. E. Kolesov

**Joint Institute for Nuclear Research
Annual Report 2002**

2003-45

Редакторы *Е. И. Кравченко, С. Ю. Романов, А. Честухина*
Технический редактор *Е. Н. Водоватова*
Компьютерная верстка *И. Г. Андреевой, О. А. Буловой, О. В. Устиновой*

Подписано в печать 29.04.2003.
Формат 60×84/8. Бумага офсетная. Гарнитура Таймс. Печать офсетная.
Усл. печ. л. 17,90. Уч.-изд. л. 21,95. Тираж 300 экз. Заказ № 53857.

Издательский отдел Объединенного института ядерных исследований
141980, г. Дубна, Московская обл., ул. Жолио-Кюри, 6.
E-mail: publish@pds.jinr.ru
www.jinr.ru/publish/